











A r c h i t e c t u r a l   L i g h t i n g

EDITION

XX

UPDATE 2021.05

<b>i</b>	ÜBERBLICK   OVERVIEW   VUE D'ENSEMBLE	8
	STROMSCHIENE   TRACK   RAIL	26
	TISCH   TABLE   TABLE	48
	STEH   FLOOR   LAMPADAIRE	64
	WAND   WALL   APPLIQUE	106
	PENDEL   SUSPENDED   SUSPENSION	148
	ANBAU   SURFACE   APPARENT	322
	EINBAU   RECESSED   ENCASTRÉ	414
	HÖHERE SCHUTZART   HIGHER PROTECTION   INDICE DE PROTECTION SUPÉRIEUR	498
	APPENDIX	513

## STROMSCHIENE | TRACK | RAIL



MIDPIN  
MAGNETIC TRACK RECESSED 28



MIDPIN  
MAGNETIC TRACK SUSPENDED 30



MIDPOINT  
3-PHASE TRACK | C6 34



MIDPOINT  
3-PHASE TRACK DALI | C7 36

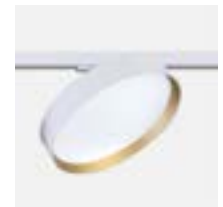

BASIC DÉCO  
3-PHASE TRACK | C3 38



CUBIC EVOLUTION  
3-PHASE TRACK | C4 40



MATRIC 38MM LENS LOUVER  
3-PHASE TRACK | C1 42



MATRIC 38MM  
3-PHASE TRACK | C1 44



3-PHASE TRACKS 46

## TISCH | TABLE | TABLE



LUCILLE  
TABLE | T1 50



LUCILLE  
TABLE | T2 52



CUBIC EVOLUTION  
TABLE | T4 54



MATRIC 38MM LENS LOUVER  
TABLE | T1 56



MATRIC 38MM LENS LOUVER  
TABLE | T2 58



MATRIC 38MM LENS LOUVER  
TABLE | T3/T4 60



MATRIC 38MM LENS LOUVER  
TABLE | T5 62

## STEH | FLOOR | LAMPADAIRE



BASIC NEO  
FLOOR | F2 70



BASIC NEO  
FLOOR | F4 72



BASIC DÉCO  
FLOOR | F3 74



BASIC DÉCO  
FLOOR | F5 76



BEAM ME UP JR.  
FLOOR | F3 78



BEAM ME UP JR.  
FLOOR | F4 80



CUBIC EVOLUTION  
FLOOR | F2 86



CUBIC EVOLUTION  
FLOOR | F3 88

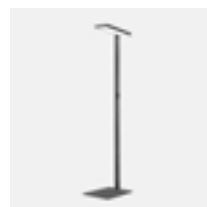

CUBIC EVOLUTION  
FLOOR | F4 90



CUBIC EVOLUTION  
FLOOR | F5 92



CUBIC EVOLUTION  
FLOOR | F6 94



CUBIC EVOLUTION  
FLOOR | F7 96



CUBIC EVOLUTION  
FLOOR | F8 98



MATRIC 38MM LENS LOUVER  
FLOOR | F2 102



MATRIC 38MM LENS LOUVER  
FLOOR | F7 104



LUCILLE  
WALL | W1 108



BASIC NEO  
WALL | A5 114



BASIC NEO  
WALL | W5 116



BASIC DECO  
WALL | A3 118

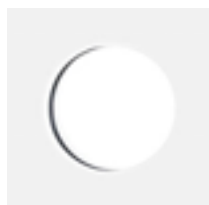

BASIC AMBIENT  
WALL | A6 120



CALEO  
WALL | W3 122



CALEO MINI  
WALL | W4 124



CALEO LINEAR  
WALL | W4 126



CUBIC EVOLUTION  
WALL | W4 128



CUBIC EVOLUTION  
WALL | J4 130



CUBIC EVOLUTION  
WALL | Y6/ X6 132



CUBIC AMBIENT  
WALL | A7 134



MATRIC 38MM  
WALL DIRECT-INDIRECT | W1 136



MATRIC 38MM  
WALL DIRECT | D2 138



MATRIC 38MM  
WALL INDIRECT | J1 140



MATRIC 55MM  
WALL DIRECT | D3 142



MATRIC 55MM  
WALL DIRECT-INDIRECT | W4 144



MATRIC 81MM  
WALL DIRECT-INDIRECT | W5 146

PENDEL | SUSPENDED | SUSPENSION



MIDPOINT  
SUSPENDED | P7/P8 150



RINGO STAR + MIDPOINT  
SUSPENDED | G1/P1 152



BASIC SUPERFLAT  
SUSPENDED | G7/P7 158



BASIC NEO  
SUSPENDED | G5/P5 160



BASIC DÉCO  
SUSPENDED | G3/P3 162



BASIC DÉCO XXL  
SUSPENDED | G4/P4 164



BASIC MAX  
SUSPENDED | G1/P1 166



BASIC AMBIENT  
SUSPENDED | G6 168



BEAM ME UP JR  
SUSPENDED | G3/P3 170



BEAM ME UP  
SUSPENDED | G1/P1 176



RINGO STAR 38MM  
SUSPENDED | G6/P6 194



RINGO STAR 60MM  
SUSPENDED | G3/P3 196



RINGO STAR 100MM  
SUSPENDED | G1/P1 198



RINGO STAR 60MM ACOUSTIC  
SUSPENDED | G3/P3 200



RINGO STAR 100MM ACOUSTIC  
SUSPENDED | G1/P1 202



RINGO STAR CLUSTER  
SUSPENDED | G3/P3 210



RINGO STAR READY CHAIN  
SUSPENDED | G3/P3 212



LIQUID LINE LINEAR MODULES  
SUSPENDED | G3/P3 224



LIQUID LINE BEND MODULES  
SUSPENDED | G3/P3 226



LIQUID LINE CURVE MODULES  
SUSPENDED | G3/P3 228



LIQUID LINE WAVE MODULES  
SUSPENDED | G3/P3 230



LIQUID LINE X-JUNCTIONS  
SUSPENDED | G3/P3 232



LIQUID LINE Y-JUNCTIONS  
SUSPENDED | G3/P3 234



AMORPHICON  
SUSPENDED | G/P 238



CODE ZERO  
SUSPENDED | G3/P3 244



THREE PEAKS  
SUSPENDED | G/P 248



CALEO INVERSE  
SUSPENDED | G3/P3 252



CALEO LINEAR  
SUSPENDED | G3/R4 254



CALEO SUSPENDED | G1/P1 256



CALEO SUSPENDED | G2/P2 258



CUBIC EVOLUTION SUSPENDED | G4/P4 262



CUBIC EVOLUTION SYSTEM SUSPENDED | G4/P4 264



CUBIC EVOLUTION SUSPENDED | U4 266



CUBIC EVOLUTION SUSPENDED | R4 268



CUBIC EVOLUTION SUSPENDED | G5/P5 270



CUBIC EVOLUTION SUSPENDED | G6/P6 272



CUBIC EVOLUTION CLUSTER SUSPENDED | G6/P6 274



CUBIC MAX SUSPENDED | G2/P2 276



CUBIC AMBIENT SUSPENDED | G7/P7 278



MATRIC 38MM SQUARE SUSPENDED | G1/R1 280



MATRIC 38MM SQUARE ACOUSTIC SUSPENDED | G1/R1 282



MATRIC 38MM BAFFLE SUSPENDED | G1 284



MATRIC 38MM LENS LOUVER SUSPENDED | P2 286



MATRIC 38MM WORK ZONE SUSPENDED | P1 298



MATRIC 38MM LENS LOUVER SUSPENDED DIRECT | G1 300



MATRIC 38MM SUSPENDED DIRECT | G1 302



MATRIC 38MM LENS LOUVER SUSP. DIRECT-INDIRECT | R1 304



MATRIC 38MM SUSPENDED DIRECT-INDIRECT | R1 306



MATRIC 55MM SUSPENDED DIRECT | G3 308

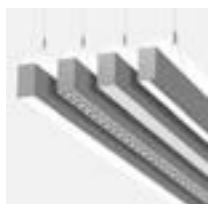

MATRIC 55MM SUSPENDED DIRECT-INDIRECT | R3 310



MATRIC 55MM SUSPENDED DIRECT-INDIRECT | R4 312



MATRIC 81MM SUSPENDED DIRECT | G5 314



MATRIC 81MM SUSPENDED DIRECT | G6 316



MATRIC 81MM SUSPENDED DIRECT-INDIRECT | R6 318



VISION SUSPENDED | G2/P2 320

ANBAU | SURFACE | APPARENT



MIDPOINT SURFACE | B7 326



MIDPOINT SURFACE | A6 328



BASIC SUPERFLAT SURFACE | Y7/X7 334



BASIC NEO SURFACE | A5 336



BASIC AMBIENT SURFACE | A6 338



BASIC DECO SURFACE | A3 340



BASIC DÉCO XXL SURFACE | A4 342



BASIC DÉCO TILTTABLE SURFACE | Z3 344



BASIC MAX SURFACE | A1 346



BASIC MAX SURFACE | Y1/X1 348



BEAM ME UP JR SURFACE | Y3/X3 350



BEAM ME UP SURFACE | Y1/X1 354



BEAM ME UP WALLWASHER SURFACE | A4 356



RINGO STAR 60MM SURFACE | A3 360



RINGO STAR 100MM SURFACE | A1 362



LIQUID LINE SURFACE | A3 366



THREE PEAKS SURFACE | A 370



CALEO INVERSE SURFACE | A3 372



CALEO LINEAR SURFACE | A3 374



CALEO SURFACE | Y1/X1 376



CALEO SURFACE | A2 378



CALEO SURFACE | Y2/X2 380



CUBIC EVOLUTION SURFACE | Y4/X4 382



CUBIC EVOLUTION SURFACE | Y5/X5 384



CUBIC EVOLUTION SURFACE | Y6/X6 386



CUBIC MAX SURFACE | A2 388



CUBIC MAX SURFACE | Y2/X2 390



CUBIC AMBIENT SURFACE | A7 392



MATRIC 38MM SQUARE SURFACE | A1 394



MATRIC 38MM LENS LOUVER SURFACE | A1 402



MATRIC 38MM SURFACE | A1 404



MATRIC 55MM SURFACE | A3 406



MATRIC 81MM SURFACE | A5 408



MATRIC 81MM SURFACE | A6 410



VISION SURFACE | A2 412

# EINBAU | RECESSED | ENCASTRÉ



MIDPOINT RECESSED | M2 416



MIDPOINT SEMI-RECESSED | E6 418

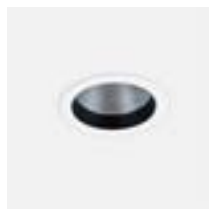

MIDPOINT RECESSED | F7 420



MIDPOINT RECESSED | M6 422

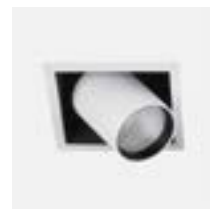

MIDPOINT RECESSED | K6 424

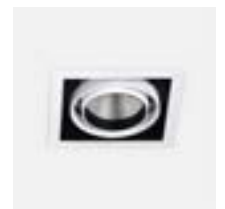

MIDPOINT RECESSED | Q6 426



MIDPOINT RECESSED | D6 430



BASIC SUPERFLAT SEMI-RECESSED | L7 432



BASIC MAX RECESSED AURA | N1 434



BASIC MAX RECESSED FRAMELESS | M2 440



BASIC MAX RECESSED FRAME | M4 442



BASIC AMBIENT SEMI-RECESSED | M6 444



BASIC MAX RECESSED MODULE | M8 446



RINGO STAR 100MM RECESSED | F1 448



LIQUID LINE RECESSED | F3 458



CALEO LINEAR RECESSED | L3 460



CALEO RECESSED | M2 462



CUBIC MAX RECESSED AURA | N2 464



CUBIC MAX RECESSED FRAMELESS | M2 466



CUBIC MAX RECESSED FRAME | M4 468



CUBIC AMBIENT SEMI-RECESSED | M7 470



CUBIC MAX RECESSED MODULE | M8 476



CUBIC MAX RECESSED MODULE | M9 478



MATRIC 38MM LENS LOUVER RECESSED FRAMELESS | M1 482



MATRIC 38MM RECESSED FRAMELESS | M1 484



MATRIC 38MM LENS LOUVER RECESSED FRAME | F1 486



MATRIC 38MM RECESSED FRAME | F1 488



MATRIC 55MM RECESSED FRAMELESS | M3 490



MATRIC 55MM RECESSED FRAME | F3 492



MATRIC 81MM RECESSED FRAMELESS | M5 494



MATRIC 81MM RECESSED FRAME | F5 496

# HÖHERE SCHUTZART | HIGHER PROTECTION | INDICE DE PROTECTION SUPÉRIEUR



BASIC MAX SURFACE IP54 | A1 500



MATRIC 38MM SURFACE IP54 | A1 504



MATRIC 55MM SURFACE IP54 | A3 506



MATRIC 38MM RECESSED FRAME IP54 | F1 508



MATRIC 55MM RECESSED FRAME IP54 | F3 510



# WELCOME: TO LIGHTNET



## LIGHTNET COMPANY LOCATIONS:

### LIGHTNET USA:

Lightnet USA Inc.  
Grove Forest Plaza  
2937 SW 27th Avenue, Suite 305  
Miami, FL 33133  
Tel.: +1 (800) 940 9092  
E-Mail: [info@lightnet.us](mailto:info@lightnet.us)  
[www.lightnet.us](http://www.lightnet.us)

### LIGHTNET MEXICO:

Lightnet Mexico S.C.  
Calle Francisco Ortega 30  
Col. Villa Coyoacan  
CP 04000, Mexico DF  
Tel.: +52 55 4916 9245  
Mail: [info@lightnet.mx](mailto:info@lightnet.mx)

### LIGHTNET HEADQUARTERS GERMANY:

Lightnet GmbH  
Zollstockgürtel 63  
50969 Köln  
Tel.: +49 (0) 221 22 25 26-0  
Mail: [info@lightnet.de](mailto:info@lightnet.de)

### LIGHTNET POLAND:

Lightnet Sp. z o.o.  
ul. Sportowa 2  
43-356 Kobiernice  
Tel +48 (33) 810 86 56

Lightnet-Kety  
ul. Fabryczna 8D  
32-650 Kęty  
Tel.: +48 (33) 506 53 04  
Mail: [info@lightnet.pl](mailto:info@lightnet.pl)



**DE**

Lightnet design und produziert professionelle Gebäudebeleuchtungen. Mehr als 450 Mitarbeiter an fünf Standorten eint das Ziel, ihre Kunden zu begeistern. Mit Lichtlösungen, die ästhetisch und technologisch gleichermaßen überzeugen. Wir sind weltweit präsent, dank über 40 eigener Vertriebsorganisationen. Zahlreiche internationale Projekte mit renommierten Architekten und Lichtplanern sind Ausdruck unserer Lichtkompetenz.

Willkommen bei Lightnet!

**EN**

Lightnet designs and produces professional architectural lighting. More than 450 employees at five locations are united by the goal of inspiring their customers. With lighting solutions that convince aesthetically and technologically. We have a global presence, thanks to over 40 of our own sales organisations. Numerous international projects with renowned architects and lighting planners are an expression of our lighting competence.

Welcome to Lightnet!

**FR**

Lightnet design et fabrique de l'éclairage professionnel de bâtiments. Plus de 450 employés répartis sur 5 sites sont unis dans le seul but de surprendre et inspirer leurs clients. Avec des solutions d'éclairage qui impressionnent et convainquent à la fois esthétiquement et technologiquement, nous sommes présents dans le monde entier grâce à plus de 40 structures et organisations commerciales. De nombreux projets internationaux réalisés avec des architectes et concepteurs lumière renommés sont l'expression de nos compétences en matière d'éclairage.

Bienvenue chez Lightnet!

# MANUFACTURING: SEAMLESSLY INHOUSE

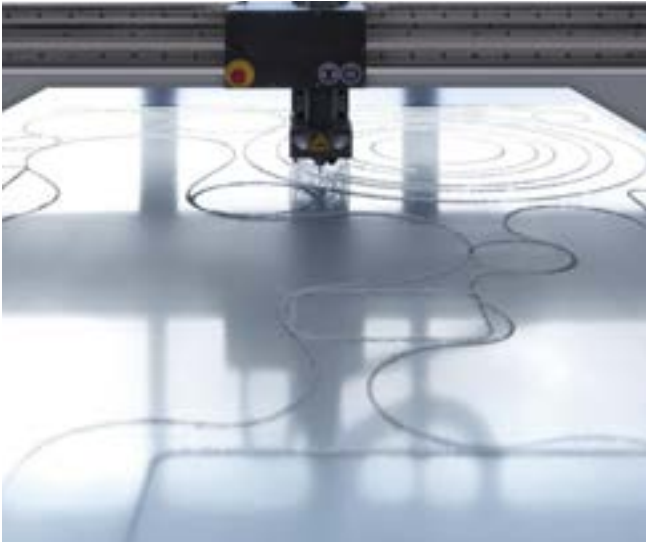

**DE**

Jedes Produkt unseres Portfolios entwickeln und produzieren wir in Eigenregie. Hierzu betreiben wir eine der modernsten LED-Produktionsstätten Europas: Mit 16.000 Quadratmetern bietet sie ausreichend Fläche für den kompletten Prozess, von der Idee bis zur Serienreife. Von der Optikberechnung, Temperatursimulation, Layout-Entwicklung, LED-Platinenfertigung und SMD-Bestückung über alle mechanischen Fertigungsschritte und umfangreichen Oberflächentechnologien bis zu elektrotechnischen und lichttechnischen Prüflaboren ist alles unter einem Dach vereint. Dies garantiert kurze Wege und höchste Flexibilität.

**EN**

We develop and produce every product in our portfolio in-house. For this we operate one of the most modern LED production sites in Europe: on 16,000 square meters there is adequate space for the complete process, from the idea to series production. From optics calculation, temperature simulation, layout development, LED board production and SMD assembly to all mechanical production steps as well as extensive surface technologies and electro technical and photometric test laboratories, everything is united in one place. This guarantees efficient processes and maximum flexibility.

**FR**

Chaque produit de notre offre est développé et fabriqué entièrement par nos propres soins. À cet effet, nous exploitons l'un des sites de production de LED les plus modernes d'Europe: avec 16 000 mètres carrés, il offre suffisamment de place et d'espace pour ce processus complet et complexe démarrant de l'idée puis de la conception, jusqu'à la mise en production finale en série. De la mesure et calcul optique à la simulation thermique, en parallèle avec le développement de la forme et de l'agencement du circuit imprimé, de la production du circuit imprimé (PCB) et assemblage CMS des chips/points LED, puis en passant ensuite par toutes les étapes de production mécanique ainsi que les technologies nombreuses de traitement de surface/corps du luminaire (couleurs, finitions diverses), jusqu'en finalité aux divers contrôles électrotechniques et des normes obligatoires par notre laboratoire de contrôle agréé; tout est regroupé et réalisé sous un seul et même toit. Cela garantit des processus et chemins raccourcis et une flexibilité maximale.

# CONFIGURATION: CUSTOM MADE



**DE**

In unserer Hightech-Produktion ist Industrie 4.0 keine Marketingfloskel, sondern Realität. Jedes Produkt ist ein Unikat und wird in einem komplexen Produktionsprozess nach Kundenwunsch konfiguriert, Eigenschaft für Eigenschaft. Hierbei sind Schnitte, Proportionen, Oberflächen, Optiken und Farbtemperaturen sortimentsübergreifend aufeinander abgestimmt, so dass Sie beliebige Produkte miteinander kombinieren können. Neben all diesen Optionen stehen Ihnen zudem komplett maßgeschneiderte Lösungen zur Verfügung. Ein solches Spektrum an Personalisierungsmöglichkeiten ist im Markt einzigartig.

**EN**

In our high-tech production industry 4.0 is not a marketing buzzword, it is reality. Each product is unique and configured in a complex production process according to customer requirements, feature by feature. Details like style, proportion, surface, optics and colour temperature are matched to each other across all collections, so it is possible to combine any products with each other. In addition to all these options, you also have completely custom-made solutions at your disposal. Such a range of customized options is unique in the market.

**FR**

Dans notre manufacture high-tech, la production industrielle 4.0 n'est pas un slogan marketing mais bien une réalité. Chaque produit est un modèle unique qui est configuré paramètre après paramètre dans un processus de production complexe selon les besoins et exigences du client. C'est ainsi que les découpes, les proportions et dimensions, les surfaces/finitions du luminaire, les différents optiques/diffuseurs et les températures de couleur au choix, s'adaptent les unes aux autres dans toutes les gammes de produits, afin que vous puissiez combiner n'importe quel luminaire les uns avec les autres. En plus de toutes ces options standards au choix, vous avez également à votre disposition des solutions sur-mesure à l'infini. Un tel spectre avec autant de possibilités multiples pour la personnalisation de vos projets, est unique sur le marché actuel.

# QUALITY: CERTIFIED

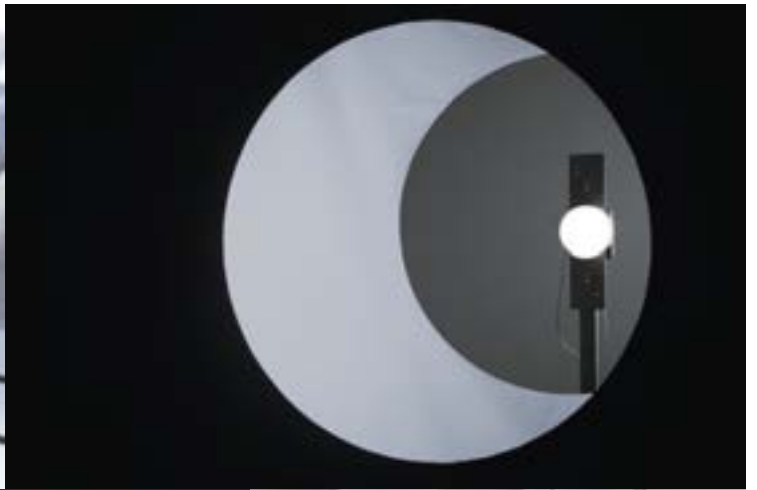

**DE**

Lightnet-Leuchten genügen höchsten Ansprüchen in puncto Qualität, Leistung und Lebensdauer. Unsere Ingenieure entwickeln sie stetig weiter. In Entwicklungs- und Testeinrichtungen, die wie Produktion und Vertrieb nach dem internationalen Qualitätsmanagementsystem DIN EN ISO 9001 zertifiziert sind. Darüber hinaus lassen wir unsere Produkte durch renommierte externe Stellen prüfen: Unser Produktportfolio mit Prüfzeichen für Europa (ENEC), USA/Kanada (ETL), Mexico (NOM) und Australien (RCA) wächst stetig. Lightnet fertigt qualitativ hochwertige und langlebige Güter und gewährt auf das gesamte Sortiment eine Garantie von 5 Jahren.

**EN**

Lightnet luminaires meet the highest demands in terms of quality, performance and product life. Our engineers keep developing them on an ongoing basis. This takes place in development and test laboratories which, like production and sales, are certified according to the international quality management system DIN EN ISO 9001. In addition, we have our products tested by renowned external agencies: Our product portfolio with certification marks for Europe (ENEC), USA/Canada (ETL), Mexico (NOM) and Australia (RCA) is constantly growing. Lightnet manufactures high-quality, durable goods and offers a 5-year warranty on the entire product range.

**FR**

Les luminaires Lightnet répondent aux attentes les plus élevées en termes de qualité, de performances et de durée de vie. Nos ingénieurs les développent constamment. Nos services du développement et tests, tout comme ceux de notre production et force de vente, sont certifiées selon le système de management international de qualité DIN EN ISO 9001. De plus, nos produits sont également testés par des organismes externes renommés: notre portefeuille de produits ne cesse de croître et sont certifiés par des normes internationales comme (ENEC) pour l'Europe, (ETL) pour les États-Unis / Canada, (NOM) pour le Mexique et (RCA) pour l'Australie. Lightnet fabrique des produits de haute qualité à longue durée de vie et offre une garantie de 5 ans sur toute sa gamme.



# COLOUR TEMPERATURES, RENDERING & SPECTRUM:

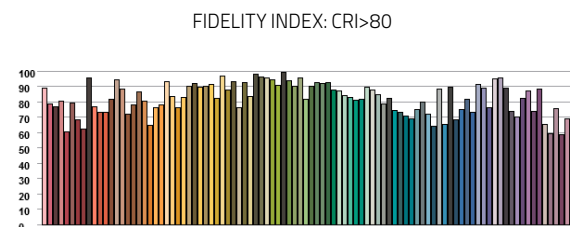
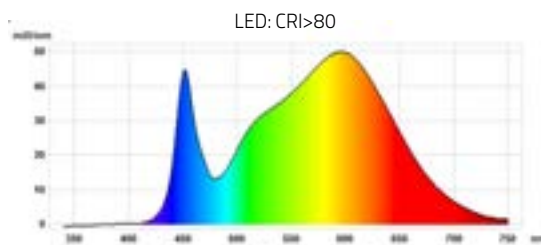
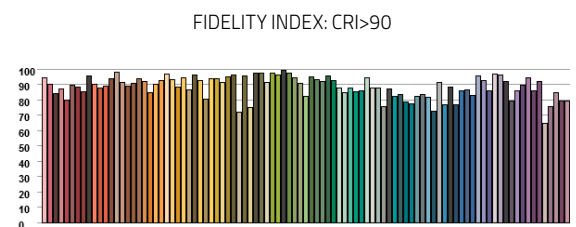
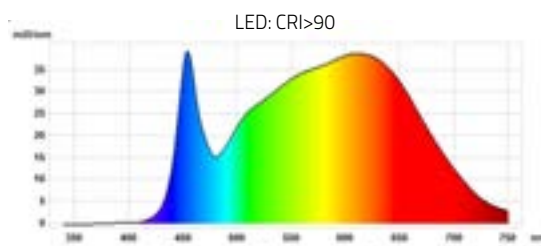
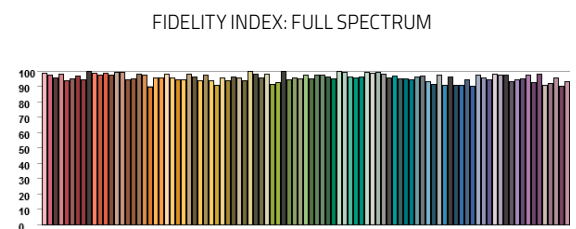

**DE**

Licht setzt Architektur in Szene. Lichtfarbe, Farbwiedergabe und spektrale Zusammensetzung wirken zudem auf Lebensrhythmus, Stimmung und Leistungsfähigkeit. Um Ihnen eine möglichst differenzierte Lichtgestaltung zu ermöglichen, bieten wir unsere Leuchten produktübergreifend in einer großen Bandbreite an Farbtemperaturen von 2200K bis 6500K an. Nahezu jede unsere Leuchte ist in den marktüblichen Farbwiedergabe-Standards CRI>80 und CRI>90 erhältlich. Und wir gehen noch einen Schritt weiter: Wir ermöglichen die Konfiguration des Lichtspektrums. Unser dem Sonnenlicht nachempfundenem Full-Spectrum-Standard beeinflusst die Gesundheit positiv und garantiert ungeahnt lebendige Farben und starke Kontraste. Unser Vertrieb berät Sie gerne bei der Umsetzung Ihrer Human Centric Konzepte!

**EN**

Light creates the atmosphere for architecture. Light colour, colour rendering and spectral composition also affect the rhythm of life, mood and performance. In order to enable you to achieve the most differentiated lighting design, we offer our luminaires in a wide range of colour temperatures from 2200K to 6500K for all products. Almost all of our luminaires are available in the colour rendering standards CRI>80 and CRI>90. And we go even further: we offer the configuration of the light spectrum. Our Full Spectrum standard, which is based on sunlight, has a positive effect on health and guarantees unsuspected vivid colours and strong contrasts. Our sales department will be happy to advise you on the implementation of your Human Centric concepts!

**FR**

La lumière met l'architecture en scène. La couleur de la lumière, le rendu des couleurs et la composition spectrale agissent sur notre rythme de vie, sur l'humeur et également sur nos performances. Afin de vous offrir une possibilité différente de la conception d'éclairage, nous proposons tous nos luminaires au travers d'une large gamme de températures de couleurs allant de 2200K à 6500K. Presque tous nos luminaires sont disponibles dans les rendus de couleurs standard du marché CRI>80 et CRI>90. Et nous allons encore plus loin: nous rendons possible la configuration du spectre lumineux. Notre spectre complet reproduit sur le modèle de la lumière du jour et du soleil, a un effet bénéfique sur la santé et garantit des couleurs vivantes et contrastes forts. Notre équipe commerciale se fera un plaisir de vous conseiller et vous accompagner sur la mise en œuvre de vos concepts d'éclairage Human Centric Lighting!

# MANIFOLD: OUR SURFACE DESIGNS

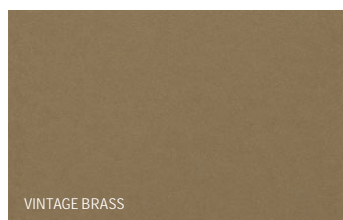
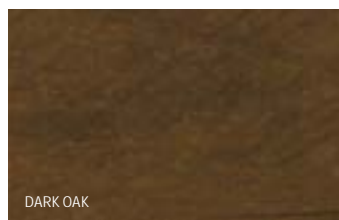
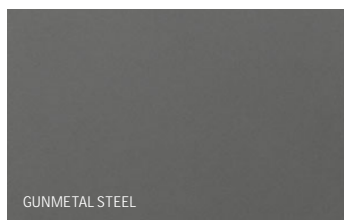
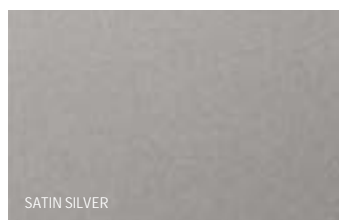
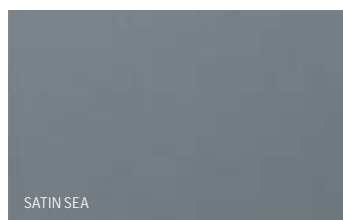
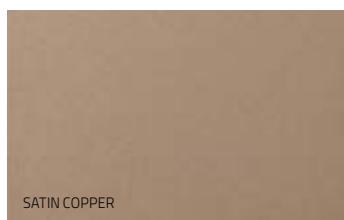
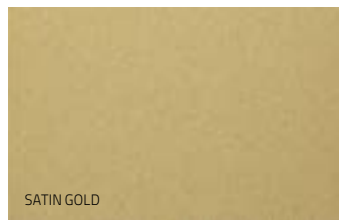
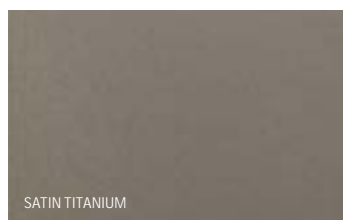
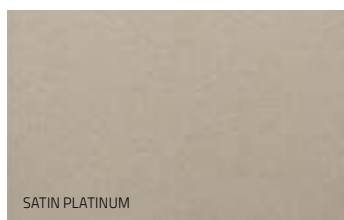
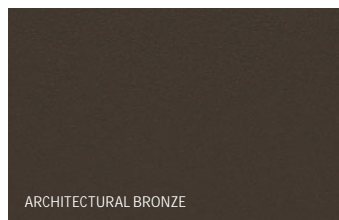
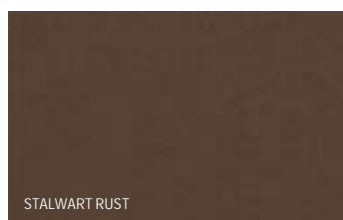
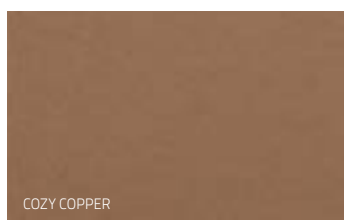
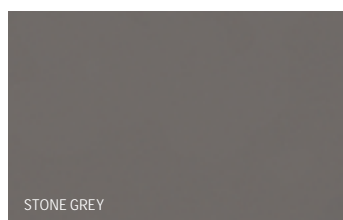
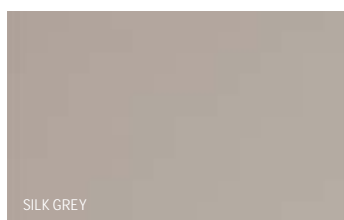
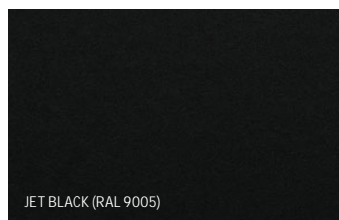
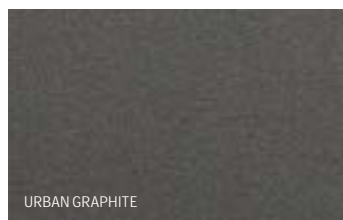
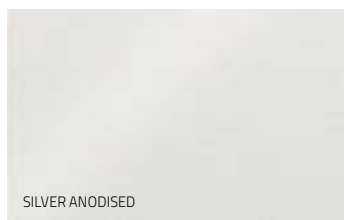

**DE**

Die stimmige Umsetzung eines Interior Design-Konzeptes lebt auch von der punktgenauen Oberflächengestaltung der Leuchten. Deshalb liefern wir Ihnen unsere Leuchten auf Wunsch im RAL-Farbtönen Ihrer Wahl. Außerdem stehen Ihnen 24 hochwertige Oberflächen zur Verfügung. Das ist möglich, weil wir in unserer Produktion unterschiedlichste industrielle und handwerkliche Techniken einsetzen. Wir verwenden eine breite Farbpalette ebenso wie vielfältige Designs und Strukturen. Oder unterschiedliche Materialien wie Hölzer, Metalle und Beton. So profitieren Sie von enormen Gestaltungsmöglichkeiten.

**EN**

The harmonious implementation of an interior design concept also depends on the focused surface design of the luminaires. That's why we can supply our luminaires in the RAL colour of your choice on request. In addition, 24 high-quality surfaces are available. This is possible because we use various industrial and craft techniques in our production. We use a wide range of colours as well as diverse designs and structures. Or different materials such as woods, metals and concrete. In this way you benefit from enormous design possibilities.

**FR**

La mise en œuvre harmonieuse d'un concept de design d'intérieur dépend également du choix précis des surfaces et finitions des luminaires. C'est pourquoi nous livrons nos luminaires sur demande dans les couleurs RAL de votre choix. Lightnet vous proposent également 24 surfaces et finitions spéciales de haute qualité propres à notre marque. Tout cela est possible car nous utilisons différentes techniques industrielles et manuelles variées de production. Nous utilisons une palette très large de couleurs comme également divers designs, structures et finitions ainsi que différents matériaux comme le bois, les métaux et le béton. Vous bénéficiez et profitez ainsi d'énormes possibilités de conception.

# RECYCLED PACKAGING



**DE**

Seit der Gründung des Unternehmens steht Lightnet für kooperative, soziale Verantwortung. Unternehmerisch handeln bedeutet für uns, nachhaltig zu handeln. Unsere Produktion und Logistik geht äußerst sparsam mit natürlichen Ressourcen um. Ein Beispiel: Wir vermeiden Folien und Kunststoffe. Zum Verpacken und Versenden unserer Produkte verwenden wir ausschließlich teils eigens hierfür entwickelte Kartons aus recycelter Pappe.

**EN**

Since the company was founded, Lightnet has represented cooperative, social responsibility. For us, acting entrepreneurially means acting sustainably. Our production and logistics are extremely economical with natural resources. One example: We avoid foils and plastics. For packaging and shipping our products, we only use cardboard boxes made of recycled cardboard, some of which have been specially developed for this purpose.

**FR**

Depuis la création de l'entreprise, Lightnet est synonyme de responsabilité sociale et de coopération. Être une entreprise performante signifie avant tout d'agir sur le long terme. Notre production et notre logistique sont extrêmement économes avec l'utilisation des ressources naturelles. Un exemple: nous évitons le maximum de composants plastiques pour les emballages. Pour le conditionnement et l'expédition de nos produits, nous utilisons uniquement des emballages en carton recyclé, dont certains ont été spécialement développés à cet effet par nos propres soins.

# YOUR PLANS: OUR SUPPORT

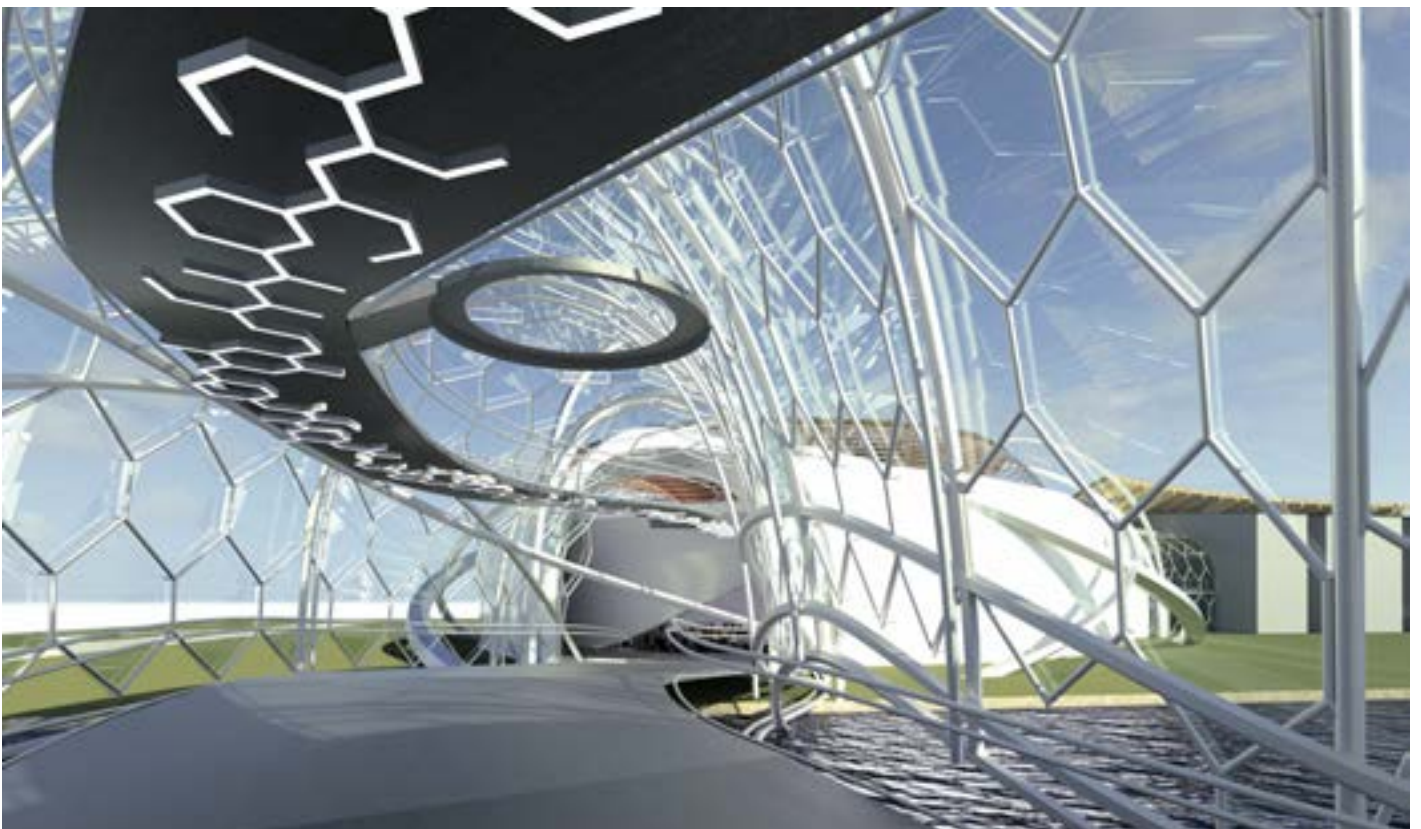
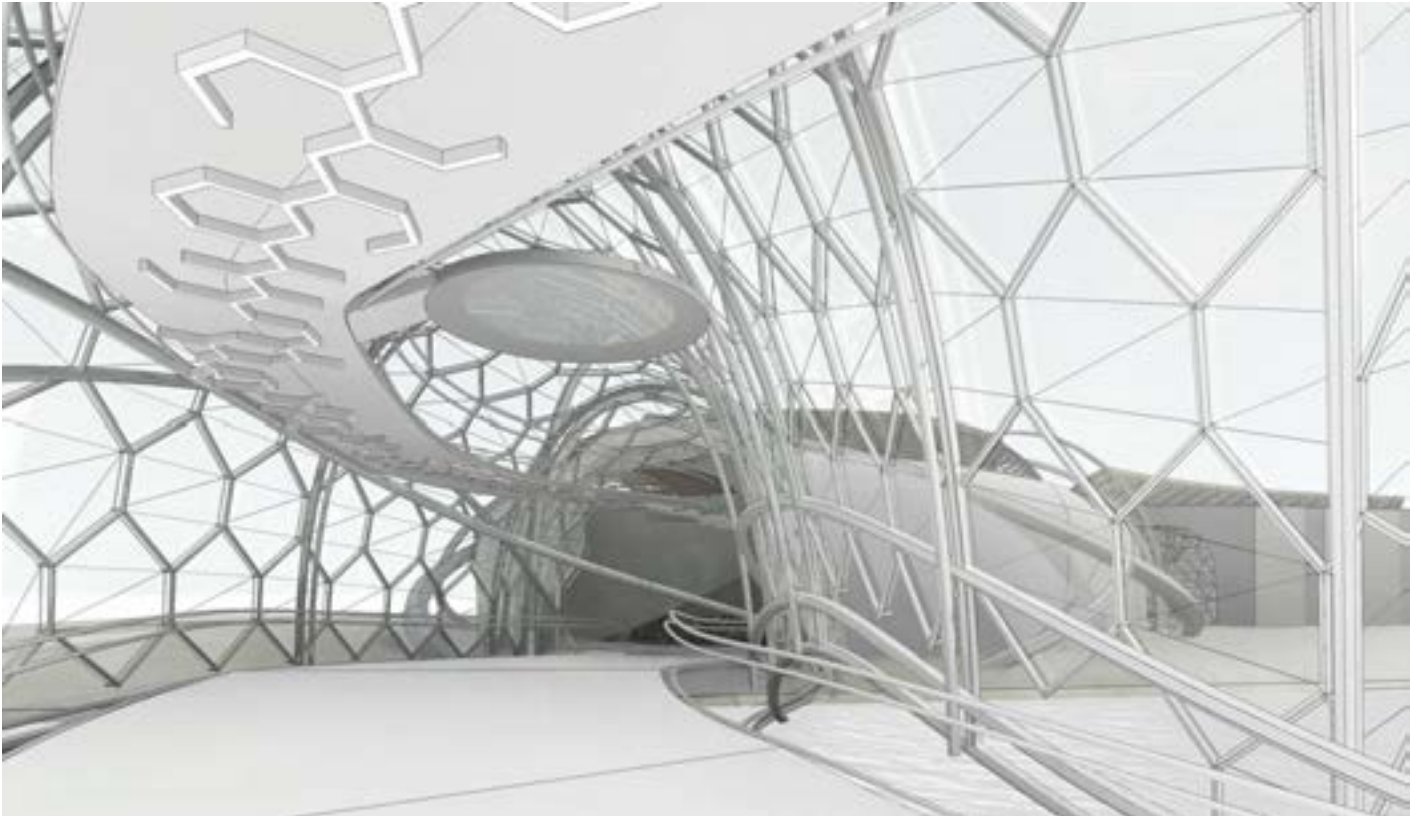

**DE**

Während des Planungsprozesses beraten wir Sie gerne professionell und persönlich. Darüber hinaus hält unsere Homepage nützliche Daten für Ihre Planung bereit. Ldt- und ies-Dateien für Ihre lichttechnischen Berechnungen sind ebenso schnell gefunden wie unser DIALUX-Plugin. Für 3D-Visualisierung und die Einrichtungsplanung mit P-CON-Planner stehen OFML-Dateien zur Verfügung. Und für Ihre BIM-Projekte liefert unsere Website über Revit alle Lightnet-Leuchten im RFA-Format. Nicht zuletzt hilft Ihnen unser Konfigurator dabei, Lichtkanal-Projekte mit unseren Produktfamilien Matric und Liquid Line in Rekordzeit zu planen.

**EN**

During the planning process we will be happy to assist you professionally and personally. In addition, our website provides useful data for your planning. Ldt- and ies-files for your lighting calculations can be found just as quickly as our DIALUX-Plugin. OFML files are available for 3D visualisation and interior planning with P-CON-Planner. And for your BIM projects, our website provides all Lightnet luminaires in RFA format via Revit. Last but not least, our configurator helps you to plan light channel projects with our Matric and Liquid Line product families in no time at all.

**FR**

Nous vous accompagnons professionnellement et personnellement pendant le processus de conception et de planification de vos projets. De plus, notre site internet met à votre disposition toutes les données utiles nécessaires. Les fichiers LDT et IES pour vos notes de calculs d'éclairage peuvent être téléchargés aussi rapidement que notre plugin DIALUX. Les fichiers OFML sont disponibles pour la visualisation 3D et l'aménagement intérieur par le logiciel de planification P-CON-Planification. Et pour vos projets BIM, notre site internet fournit également tous les fichiers des luminaires Lightnet au format RFA via le logiciel Revit. Et surtout en finalité, notre configurateur vous aide à planifier en un temps record, vos projets sur-mesure et solutions d'éclairage de nos familles de produits et systèmes modulaires lumineux MATRIC et LIQUID LINE.



# ALMOST REAL: LIGHTNET IMAGINE! APP

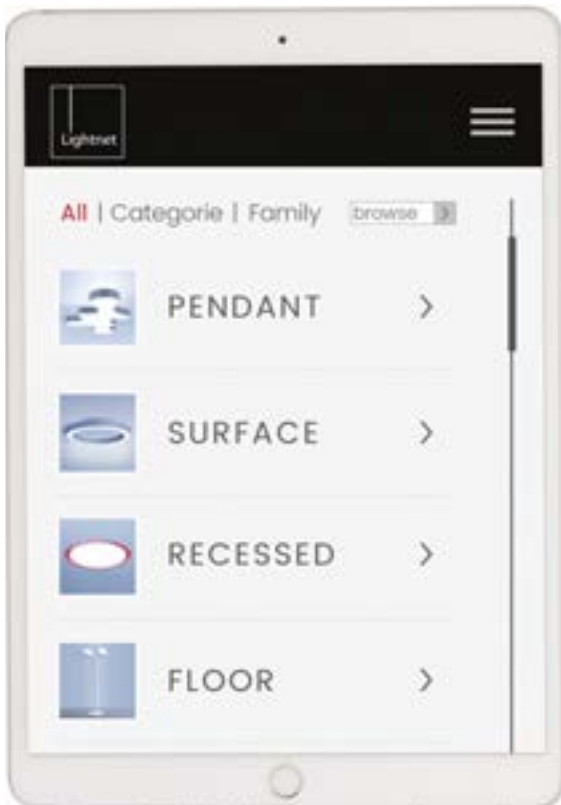

Now available on  
App Store  
and  
Play Store

**DE**

Lightnet Imagine! ist unsere App für Augmented Reality. Die mobile App ermöglicht Ihnen und Ihren Kunden mittels Smartphone oder Tablet, unsere Leuchten als virtuelle Modelle in das Bild Ihres realen Projektes einzublenden - in Echtzeit. Dank einer einfachen Menüführung sind die ausgewählten Objekte schnell in der gewünschten Farbe und Größe an der entsprechenden Stelle positioniert. Das erleichtert Entscheidungen zu Proportion und Design und erspart häufig sogar eine zeit- und arbeitsintensive Bemusterung. Lightnet Imagine! ist im App-Store und Playstore kostenlos verfügbar.

**EN**

Lightnet Imagine! is our app for Augmented Reality. The mobile app allows you and your customers to use your smartphone or tablet to fade in our luminaires as virtual models into the image of your real project - in real time. Thanks to a user-friendly menu navigation, the selected objects are quickly positioned in the desired colour and size. This simplifies decisions on proportion and design and often even saves time-consuming and labour-intensive sampling. Lightnet Imagine! is available for free on the App Store and Playstore.

**FR**

Lightnet Imagine! est notre application pour la réalité augmentée. L'application mobile vous permet, ainsi qu'à vos clients, de faire apparaître nos lumières sous forme de modèles virtuels à l'image de votre projet et environnement réel, à l'aide d'un smartphone ou d'une tablette en temps réel. Grâce à une navigation simple dans le menu, les luminaires sélectionnés sont rapidement positionnés à l'endroit choisi dans la couleur et la taille souhaitée. Cela facilite les décisions sur le choix des proportions et du design et peut même faire économiser du temps d'un échantillonnage souvent trop long et laborieux. Lightnet Imagine! est disponible et à télécharger gratuitement dans l'App Store et le Playstore.



MIDPIN  
MAGNETIC TRACK RECESSED 28



MIDPIN  
MAGNETIC TRACK SUSPENDED 30



MIDPOINT  
3-PHASE TRACK | C6 34



MIDPOINT  
3-PHASE TRACK DALI | C7 36



BASIC DÉCO  
3-PHASE TRACK | C3 38



CUBIC EVOLUTION  
3-PHASE TRACK | C4 40



MATRIC 38MM LENS LOUVER  
3-PHASE TRACK | C1 42



MATRIC 38MM  
3-PHASE TRACK | C1 44



3-PHASE TRACKS 46

STROMSCHIENE | TRACK | RAIL

MIDPIN  
MAGNETIC TRACK RECESSED



**DE** LED-Strahler für 48V-Stromschienen mit magnetischer Halterung. Oberfläche schwarz lackiert. 350° drehbar und 90° schwenkbar. Farbtemperaturen wahlweise 2700K, 3000K oder 4000K. Binning initial  $\leq$  MacAdam 3. Farbwiedergabe CRI>90. Austauschbare Linsenoptiken mit Ausstrahlwinkel 20° (Spot), 30° (Medium) oder 40° (Flood). Wahlweise einfach schaltbar oder stufenlos dimmbar (DALI). Separat bestellbare 48V-Stromschiene für rahmenlosen Einbau in vertikale und horizontale Gipskartondecken. Sichtbare Fugenbreite 23mm, schwarz lackiert. Maximale Systemflexibilität durch umfangreiches Standardsortiment an Winkelverbindern sowie Zuschnitt nach Maß.

**EN** LED spotlight for 48V tracks with magnetic holder. Surface black coated. 350° rotatable and 90° tiltable. Colour temperatures optionally 2700K, 3000K or 4000K. Binning initial  $\leq$  MacAdam 3. Colour rendering CRI>90. Changeable lens optics with beam angle 20° (spot), 30° (medium) or 40° (flood). Optionally switchable or dimmable (DALI). 48V track can be ordered separately for frameless installation in vertical and horizontal plasterboard ceilings. Visible joint width 23mm, black coated. Maximum system flexibility due to extensive standard range of angle connectors and custom-made lengths.

**FR** Projecteur LED pour rail 48V à système de fixation magnétique. Surface laquée noir. Orientable à 350° et pivotant à 90°. Température de couleur 2700K, 3000K ou 4000K. Binning initial  $\leq$  MacAdam 3. Rendu de couleur CRI>90. Optique de lentilles interchangeable avec faisceau/angle d'ouverture 20°(spot), 30°(medium) ou 40° (flood). Au choix ON/OFF ou graduable (DALI). Rail 48V à commander séparément pour montage en encastrement sans cadre (frameless), pour plafonds et murs BA13 ou similaire. Joint visible de 23mm, thermolaqué noir. Flexibilité du système maximale grâce à un assortiment standard très large d'angles de jonctions tout comme de découpes sur-mesures.

Midpin-C2  
Build-In Version



Midpin-C3  
Suspended Version

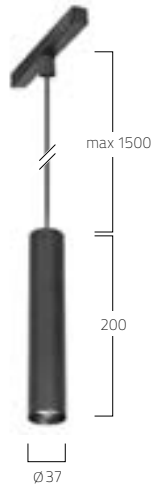

**PRODUCT-CODE:**

**D C2 A B E - 9 27 M**

PRODUCT FAMILY	- D: Midpin
TYPE	- C2: Build-In Version for Low Voltage Magnetic Track - C3: Suspended Version for Low Voltage Magnetic Track
BEAM ANGLE	- A: Spot 20°, B: Medium 30°, C: Flood 40°
SURFACE FINISH	- B: Jet Black, W: Snow White
CONTROL GEAR	- E: On/Off, L: DALI
COLOUR RENDER.	- 9: CRI>90
COLOUR TEMP.	- 27: 2700K, 30: 3000K, 40: 4000K
POWER	- M: Medium Power



**SPOT 20° LED ENGINE ECO, MEDIUM POWER**

Mounting Height	Average Illuminance [Lux] center/side	Beam Diameter
1 m	3700/1756	0.41 m
2 m	925/439	0.83 m
3 m	411/195	1.20 m
4 m	231/110	1.70 m

LED Engine	2700K	3000K	3500K	4000K
11,0W	620	720	760	760

**MEDIUM 30° LED ENGINE ECO, MEDIUM POWER**

Mounting Height	Average Illuminance [Lux] center/side	Beam Diameter
1 m	2079/929	0.57 m
2 m	520/232	1.10 m
3 m	231/103	1.70 m
4 m	130/58	2.30 m

LED Engine	2700K	3000K	3500K	4000K
11,0W	610	710	750	750

**FLOOD 40° LED ENGINE ECO, MEDIUM POWER**

Mounting Height	Average Illuminance [Lux] center/side	Beam Diameter
1 m	1454/591	0.77 m
2 m	364/148	1.50 m
3 m	162/66	2.30 m
4 m	91/37	3.10 m

LED Engine	2700K	3000K	3500K	4000K
11,0W	620	730	770	770

**TRACK RECESSED:**



X-LV-TRACK-L2000-B [BLACK]  
X-LV-TRACK-L2000-W [WHITE]

**END CAP RECESSED:**



X-LV-CAP-W [WHITE]  
X-LV-CAP-B [BLACK]

**STRAIGHT ELECTRICAL CONNECTOR:**



X-LV-ICOUPLER-B [BLACK]  
X-LV-ICOUPLER-W [WHITE]

**FEED:**



X-LV-FEED-B [BLACK]  
X-LV-FEED-W [WHITE]

**CORNER CONNECTOR:**



X-LV-LCOUPLER-B [BLACK]  
X-LV-LCOUPLER-W [WHITE]

**FLEX CONNECTOR:**



X-LV-FLEXCOUPLER-B [BLACK]  
X-LV-FLEXCOUPLER-W [WHITE]

**STRAIGHT MECHANICAL CONNECTOR:**



X-LV-CONNECTOR-B [BLACK]

**SUSPENSION SET:**



X-LV-SUSP-1,5M-B [1,5M BLACK]  
X-LV-SUSP-1,5M-W [1,5M WHITE]  
X-LV-SUSP-4M-B [4M BLACK]  
X-LV-SUSP-4M-W [4M WHITE]

**CONVERTER:**



X-LV-CONVERTER-70W-E [70W, ON/OFF]  
X-LV-CONVERTER-100W-E [100W, ON/OFF]  
X-LV-CONVERTER-150W-E [150W, ON/OFF]  
X-LV-CONVERTER-70W-L [70W, DALI]  
X-LV-CONVERTER-100W-L [100W, DALI]  
X-LV-CONVERTER-150W-L [150W, DALI]

MIDPIN  
MAGNETIC TRACK SUSPENDED



**DE** LED-Strahler für 48V-Stromschienen mit magnetischer Halterung. Rein direktstrahlend. Oberfläche schwarz lackiert. 350° drehbar und 90° schwenkbar. Farbtemperaturen wahlweise 2700K, 3000K oder 4000K. Binning initial ≤ MacAdam 3. Farbwiedergabe CRI>90. Austauschbare Linsenoptiken mit Ausstrahlwinkel 20° (Spot), 30° (Medium) oder 40° (Flood). Wahlweise einfach schaltbar oder stufenlos dimmbar (DALI). Separat bestellbare Matric-R1-Systempendelleuchten mit integrierter 48V-Stromschiene und optionalen indirekten Lichtanteil (2700K, 3000K oder 4000K). Maximale Systemflexibilität durch umfangreiches Standardsortiment an Winkelverbindern sowie Zuschnitt nach Maß.

**EN** LED spotlight for 48V tracks with magnetic holder. Direct only light distribution. Surface black coated. 350° rotatable and 90° tiltable. Colour temperatures optionally 2700K, 3000K or 4000K. Binning initial ≤ MacAdam 3. Colour rendering CRI>90. Changeable lens optics with beam angle 20° (spot), 30° (medium) or 40° (flood). Optionally switchable or dimmable (DALI). Matric-R1 system pendant luminaires can be ordered separately with integrated 48V track and optional indirect light part (2700K, 3000K or 4000K). Maximum system flexibility due to extensive standard range of angle connectors and custom-made lengths.

**FR** Projecteur LED pour rail 48V à système de fixation magnétique. Éclairage seulement direct. Surface laquée noir. Orientable à 350° et pivotant à 90°. Température de couleur 2700K, 3000K ou 4000K. Binning initial ≤ MacAdam 3. Rendu de couleur CRI>90. Optique de lentilles interchangeables avec faisceau/angle d'ouverture 20° (spot), 30° (medium) ou 40° (flood). Au choix ON/OFF ou graduable (DALI). Système suspendu modulaire MATRIC R1 avec rail 48V intégré disponible sur commande avec en option un éclairage indirect LED (2700K, 3000K ou 4000K). Flexibilité du système maximale grâce à un assortiment standard très large d'angles de jonctions tout comme de découpes sur-mesures.

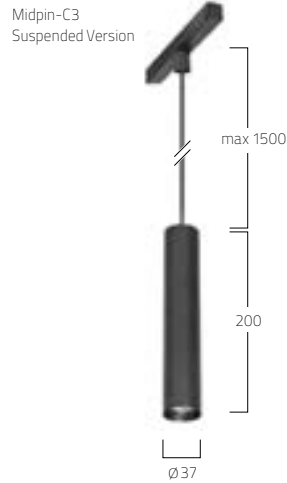

**PRODUCT-CODE:** D C2 A B E - 9 27 M

PRODUCT FAMILY	- D: Midpin
TYPE	- C2: Build-In Version for Low Voltage Magnetic Track - C3: Suspended Version for Low Voltage Magnetic Track
BEAM ANGLE	- A: Spot 20°, B: Medium 30°, C: Flood 40°
SURFACE FINISH	- B: Jet Black, W: Snow White
CONTROL GEAR	- E: On/Off, L: DALI
COLOUR RENDER.	- 9: CRI>90
COLOUR TEMP.	- 27: 2700K, 30: 3000K, 40: 4000K
POWER	- M: Medium Power



**SPOT 20° LED ENGINE ECO, MEDIUM POWER**

Mounting Height	Average Illuminance [Lux] center/side	Beam Diameter
1 m	3700/1756	0.41 m
2 m	925/439	0.83 m
3 m	411/195	1.20 m
4 m	231/110	1.70 m

LED Engine	2700K	3000K	3500K	4000K
11,0W	620	720	760	760

**MEDIUM 30° LED ENGINE ECO, MEDIUM POWER**

Mounting Height	Average Illuminance [Lux] center/side	Beam Diameter
1 m	2079/929	0.57 m
2 m	520/232	1.10 m
3 m	231/103	1.70 m
4 m	130/58	2.30 m

LED Engine	2700K	3000K	3500K	4000K
11,0W	610	710	750	750

**FLOOD 40° LED ENGINE ECO, MEDIUM POWER**

Mounting Height	Average Illuminance [Lux] center/side	Beam Diameter
1 m	1454/591	0.77 m
2 m	364/148	1.50 m
3 m	162/66	2.30 m
4 m	91/37	3.10 m

LED Engine	2700K	3000K	3500K	4000K
11,0W	620	730	770	770

**LENS | INDIRECT**

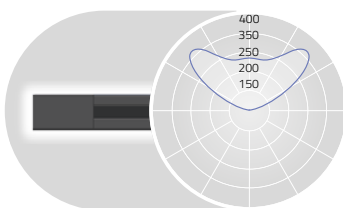

INDIRECT 100%

L mm	Lumen/Watt Medium Power	Lumen/Watt High Power
1100	1920lm/14W	2600lm/19W
2100	4030lm/26W	5450lm/35W

**MATRIC -R1**

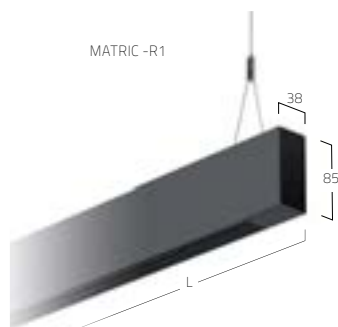

**PRODUCT-CODE:** L R1 S B E - 8 30 M - L1100 - Y

PRODUCT FAMILY	- L: Matric
TYPE	- R1: Suspended Direct-Indirect
OPTICAL SYSTEM	- S: Low Voltage Track, Lens for Indirect Lighting
SURFACE FINISH	- B: Jet Black, W: Snow White
CONTROL GEAR	- E: On/Off, L: DALI
COLOUR REND.	- 8: CRI>80, 9: CRI>90, F: Full Spectrum
COLOUR TEMP.	- 22: 2200K, 27: 2700K, 30: 3000K, 35: 3500K, 40: 4000K, 65: 6500K
POWER	- M: Medium Power, H: High Power
SIZE	- Luminaire Length in mm: L1100, L2100
SUSPENSION	- Y: Y-Cord Suspension





# MIDPOINT 3-PHASE TRACK



JOOM OFFICE, MOSCOW, RUSSIA  
MIDPOINT-C6  
ARCHITECT: V12 ARCHITECTS  
PHOTOS: POLINA POLUDKINA



VOLKSBANK BIELEFELD-GÜTERSLOH, GERMANY  
MIDPOINT-C7  
PHOTOS: PATRICK POLLMEIER

MIDPOINT  
3-PHASE TRACK | C6



**DE** LED-Strahler für 3-Phasen-Stromschienen. 350° drehbar und 90° schwenkbar. Konverter im Strahlerkopf integriert, einfach schaltbar. LED Engine wahlweise XICATO ARTIST für höchste Lichtqualität mit bester Farbwiedergabe und 5 Jahre Garantie für Farbkonstanz (MacAdams3) oder ECO für höchste Energieeffizienz bei optimalem Preis-Leistungsverhältnis und CRI>90. Farbtemperaturen 2700K, 3000K oder 4000K. Austauschbare Linsen-Reflektoroptiken mit sphärischer Facettenoptik. Ausstrahlwinkel: 10° (Spot), 20° (Medium), 35° (Flood) oder 50° (Wide Flood). Standardmäßig klare Abdeckung. Optional zusätzliche Filter oder Wabenraster. Gehäuse aus Aluminium in weiß, silber, schwarz oder champagnerfarben lackiert. Reflektorring zusätzlich in gold- oder kupferfarben erhältlich. Stromschienenadapter wahlweise EUTRAC oder GLOBAL.

**EN** LED spotlight for 3-phase tracks. 350° rotatable and 90° tiltable. Driver integrated into spotlight head, switchable. LED Engine with XICATO ARTIST for highest light quality and colour rendering, including 5 year warranty for colour consistency (MacAdams 3). Alternatively ECO for highest energy efficiency with optimal price-performance ratio and CRI> 90. Colour temperature 2700K, 3000K or 4000K. Replaceable lens reflector optics with spherical faceted optics. Beam angle: 10° (Spot), 20° (Medium), 35° (Flood) or 50° (Wide Flood). Standard clear cover. Optional additional filters or honeycomb grid. Housing made of white, silver, black or champagne coated aluminum. Reflector ring also available in gold or copper colours. Track adapter optionally EUTRAC or GLOBAL.

**FR** Projecteur LED pour système à 3 phases. Orientable à 350° et pivotant à 90°. Driver intégré dans la tête du projecteur, ON/OFF. Module/COB LED XICATO ARTIST en option pour une qualité d'éclairage maximale et un rendu des couleurs exceptionnel + 5 ans de garantie sur le niveau des couleurs (MacAdams 3) ou ECO pour une efficacité énergétique et un rapport qualité-prix optimal + IRC supérieur à 90 inclus. Température de couleur 2700K, 3000K ou 4000K. Réflecteur avec optique de lentille interchangeable et facettes de réflexion sphérique. Angle d'ouverture/faisceau: 10° (Spot), 20° (Medium), 35° (Flood) ou 50° (Wide Flood). Verre de protection et de fermeture standard. Filtrés divers supplémentaires et/ou filtre nid d'abeilles en option. Boîtier en aluminium couleurs blanc, argent, noir ou titane laqué. Bague décorative du réflecteur également disponible en or ou en cuivre. Adaptateur rail 3-Phases au choix EUTRAC ou GLOBAL.



PRODUCT-CODE:	P	C6	B	S	E	-	9	27	F	M	-	B	K	G
PRODUCT FAMILY	- P: Midpoint													
TYPE	- C6: For 3-Phase Tracks [Tube Length 155mm]													
BEAM ANGLE	- A: Spot 10°, B: Medium 20°, C: Flood 35°, D: Wide Flood 50°													
SURFACE FINISH	- W: Snow White, V: Ivory White, S: Radiant Silver, B: Jet Black, H: Champagne Silver													
CONTROL GEAR	- E: On/Off													
COLOUR RENDER.	- 9: CRI>90													
COLOUR TEMP.	- 27: 2700K, 30: 3000K, 40: 4000K													
LED-ENGINE	- F: Eco [Ra> 90], A: Artist [Ra> 97, Xicato]													
POWER	- E: Low Power M: Medium Power													
OPTIC RING	- W: Snow White, V: Ivory White, S: Radiant Silver, B: Jet Black, H: Champagne Silver, G: Satin Gold, K: Satin Copper													
COVER	- K: Clear Cover [Standard], P: Prismatic Lens, H: Honeycomb Louver, B: Dichroic Filter [Bread], M: Dichroic Filter [Meat]													
ADAPTOR	- G: Global Adaptor, E: Eutrac Adaptor													



SPOT 10° LED ENGINE ECO, MEDIUM POWER

Mounting Height	Illuminance [Lux] center/side	Beam Diameter
1 m	25250/12700	0.24 m
2 m	6312/3175	0.48 m
3 m	2806/1411	0.72 m
4 m	1578/794	0.95 m

MEDIUM 20° LED ENGINE ECO, MEDIUM POWER

Mounting Height	Illuminance [Lux] center/side	Beam Diameter
1 m	17447/8455	0.32 m
2 m	4362/2114	0.64 m
3 m	1939/939	0.96 m
4 m	1090/528	1.30 m

FLOOD 35° LED ENGINE ECO, MEDIUM POWER

Mounting Height	Illuminance [Lux] center/side	Beam Diameter
1 m	6251/2731	0.63 m
2 m	1563/683	1.30 m
3 m	695/303	1.90 m
4 m	391/171	2.50 m

WIDE FLOOD 50° LED ENGINE ECO, MEDIUM POWER

Mounting Height	Illuminance [Lux] center/side	Beam Diameter
1 m	3550/1319	0.94 m
2 m	887/330	1.90 m
3 m	394/147	2.80 m
4 m	222/82	3.80 m

LED Engine	2700K	3000K	4000K
Eco Low Power [20W]	1230	1350	1440
Eco Medium Power [31W]	1660	1860	2020
Artist Low Power [21W]	1040	1090	1190
Artist Medium Power [33W]	1400	1480	1560

LED Engine	2700K	3000K	4000K
Eco Low Power [20W]	1580	1740	1850
Eco Medium Power [31W]	2360	2640	2870
Artist Low Power [21W]	1330	1390	1510
Artist Medium Power [33W]	1980	2110	2220

LED Engine	2700K	3000K	4000K
Eco Low Power [20W]	1530	1680	1790
Eco Medium Power [31W]	2280	2550	2780
Artist Low Power [21W]	1290	1350	1470
Artist Medium Power [33W]	1930	2060	2160

LED Engine	2700K	3000K	4000K
Eco Low Power [20W]	1440	1580	1680
Eco Medium Power [31W]	2230	2490	2710
Artist Low Power [21W]	1250	1310	1430
Artist Medium Power [33W]	1910	2040	2140

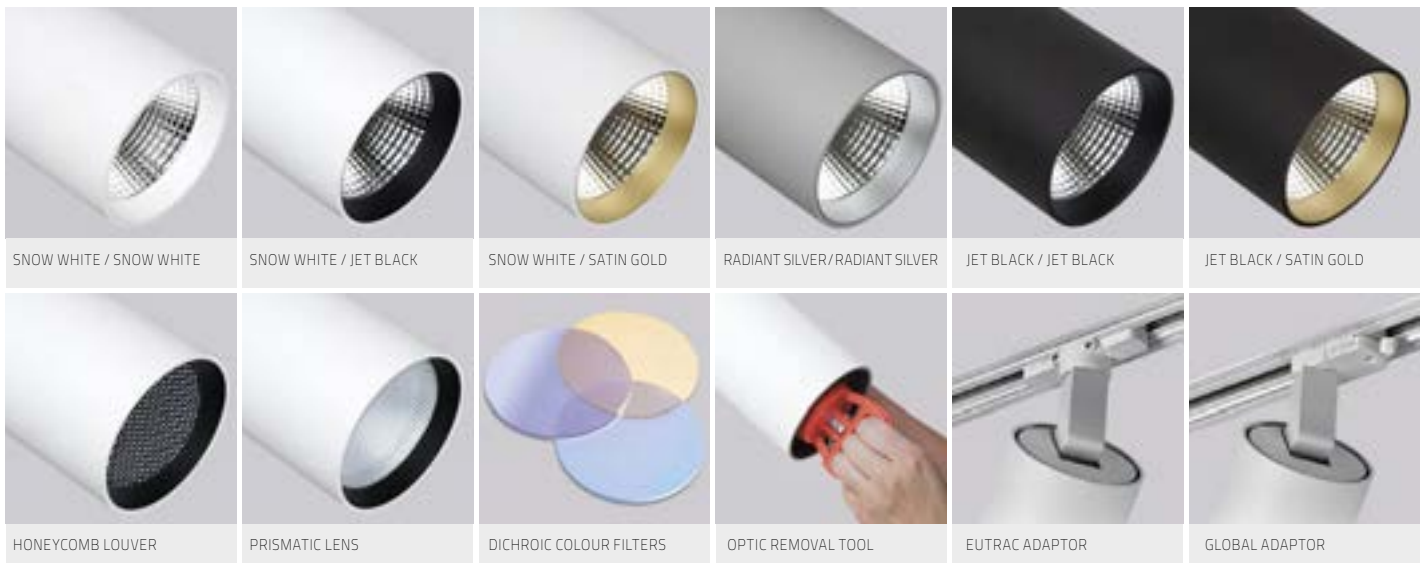

MIDPOINT  
3-PHASE TRACK DALI | C7



**DE** LED-Strahler für 3-Phasen-Stromschienen. 350° drehbar und 90° schwenkbar. Konverter im Strahlerkopf integriert, dimmbar (DALI). LED Engine wahlweise XICATO ARTIST für höchste Lichtqualität mit bester Farbwiedergabe und 5 Jahre Garantie für Farbkonstanz (MacAdams3) oder ECO für höchste Energieeffizienz bei optimalem Preis-Leistungsverhältnis und CRI>90. Farbtemperaturen 2700K, 3000K oder 4000K. Austauschbare Linsen-Reflektoroptiken mit sphärischer Facettenoptik. Ausstrahlwinkel: 10° (Spot), 20° (Medium), 35° (Flood) oder 50° (Wide Flood). Standardmäßig klare Abdeckung. Optional zusätzliche Filter oder Wabenraster. Gehäuse aus Aluminium in weiß, silber, schwarz oder champagnerfarben lackiert. Reflektorring zusätzlich in gold- oder kupferfarben erhältlich. Stromschienenadapter wahlweise EUTRAC oder GLOBAL.

**EN** LED spotlight for 3-phase tracks. 350° rotatable and 90° tiltable. Driver integrated into spotlight head, dimmable (DALI). LED Engine with XICATO ARTIST for highest light quality and colour rendering, including 5 year warranty for colour consistency (MacAdams 3). Alternatively ECO for highest energy efficiency with optimal price-performance ratio and CRI> 90. Colour temperature 2700K, 3000K or 4000K. Replaceable lens reflector optics with spherical faceted optics. Beam angle: 10° (Spot), 20° (Medium), 35° (Flood) oder 50° (Wide Flood). Standard clear cover. Optional additional filters or honeycomb grid. Housing made of white, silver, black or champagne coated aluminum. Reflector ring also available in gold or copper colours. Track adapter optionally EUTRAC or GLOBAL.

**FR** Projecteur LED pour système à 3 phases. Orientable à 350° et pivotant à 90°. Driver intégré dans la tête du projecteur, ON/OFF. Module/COB LED XICATO ARTIST en option pour une qualité d'éclairage maximale et un rendu des couleurs exceptionnel + 5 ans de garantie sur le niveau des couleurs (MacAdams 3) ou ECO pour une efficacité énergétique et un rapport qualité-prix optimal + IRC supérieur à 90 inclus. Température de couleur 2700K, 3000K ou 4000K. Réflecteur avec optique de lentille interchangeable et facettes de réflexion sphérique. Angle d'ouverture/faisceau: 10° (Spot), 20° (Medium), 35° (Flood) oder 50° (Wide Flood). Verre de protection et de fermeture standard. Filtres divers supplémentaires et/ou filtre nid d'abeilles en option. Boîtier en aluminium couleurs blanc, argent, noir ou titane laqué. Bague décorative du réflecteur également disponible en or ou en cuivre. Adaptateur rail 3-Phases au choix EUTRAC ou GLOBAL.



**PRODUCT-CODE:** P C7 B S L - 9 27 F M - B K G

PRODUCT FAMILY	- P: Midpoint
TYPE	- C7: For 3-Phase Tracks [Tube Length 215mm]
BEAM ANGLE	- A: Spot 10°, B: Medium 20°, C: Flood 35°, D: Wide Flood 50°
SURFACE FINISH	- W: Snow White, V: Ivory White, S: Radiant Silver, B: Jet Black, H: Champagne Silver
CONTROL GEAR	- L: DALI
COLOUR RENDER.	- 9: CRI>90
COLOUR TEMP.	- 27: 2700K, 30: 3000K, 40: 4000K
LED-ENGINE	- F: Eco [Ra> 90], A: Artist [Ra> 97, Xicato]
POWER	- E: Low Power, M: Medium Power
OPTIC RING	- W: Snow White, V: Ivory White, S: Radiant Silver, B: Jet Black, H: Champagne Silver, G: Satin Gold, K: Satin Copper
COVER	- K: Clear Cover [Standard], P: Prismatic Lens, H: Honeycomb Louver, B: Dichroic Filter [Bread], M: Dichroic Filter [Meat]
ADAPTOR	- G: Global Adaptor, E: Eutrac Adaptor



**SPOT 10° LED ENGINE ECO, MEDIUM POWER**

Mounting Height	Illuminance [Lux] center/side	Beam Diameter
1 m	25250/12700	0.24 m
2 m	6312/3175	0.48 m
3 m	2806/1411	0.72 m
4 m	1578/794	0.95 m

**MEDIUM 20° LED ENGINE ECO, MEDIUM POWER**

Mounting Height	Illuminance [Lux] center/side	Beam Diameter
1 m	17447/8455	0.32 m
2 m	4362/2114	0.64 m
3 m	1939/939	0.96 m
4 m	1090/528	1.30 m

**FLOOD 35° LED ENGINE ECO, MEDIUM POWER**

Mounting Height	Illuminance [Lux] center/side	Beam Diameter
1 m	6251/2731	0.63 m
2 m	1563/683	1.30 m
3 m	695/303	1.90 m
4 m	391/171	2.50 m

**WIDE FLOOD 50° LED ENGINE ECO, MEDIUM POWER**

Mounting Height	Illuminance [Lux] center/side	Beam Diameter
1 m	3550/1319	0.94 m
2 m	887/330	1.90 m
3 m	394/147	2.80 m
4 m	222/82	3.80 m

LED Engine	2700K	3000K	4000K
Eco Low Power [20W]	1230	1350	1440
Eco Medium Power [31W]	1660	1860	2020
Artist Low Power [21W]	1040	1090	1190
Artist Medium Power [33W]	1400	1480	1560

LED Engine	2700K	3000K	4000K
Eco Low Power [20W]	1580	1740	1850
Eco Medium Power [31W]	2360	2640	2870
Artist Low Power [21W]	1330	1390	1510
Artist Medium Power [33W]	1980	2110	2220

LED Engine	2700K	3000K	4000K
Eco Low Power [20W]	1530	1680	1790
Eco Medium Power [31W]	2280	2550	2780
Artist Low Power [21W]	1290	1350	1470
Artist Medium Power [33W]	1930	2060	2160

LED Engine	2700K	3000K	4000K
Eco Low Power [20W]	1440	1580	1680
Eco Medium Power [31W]	2230	2490	2710
Artist Low Power [21W]	1250	1310	1430
Artist Medium Power [33W]	1910	2040	2140

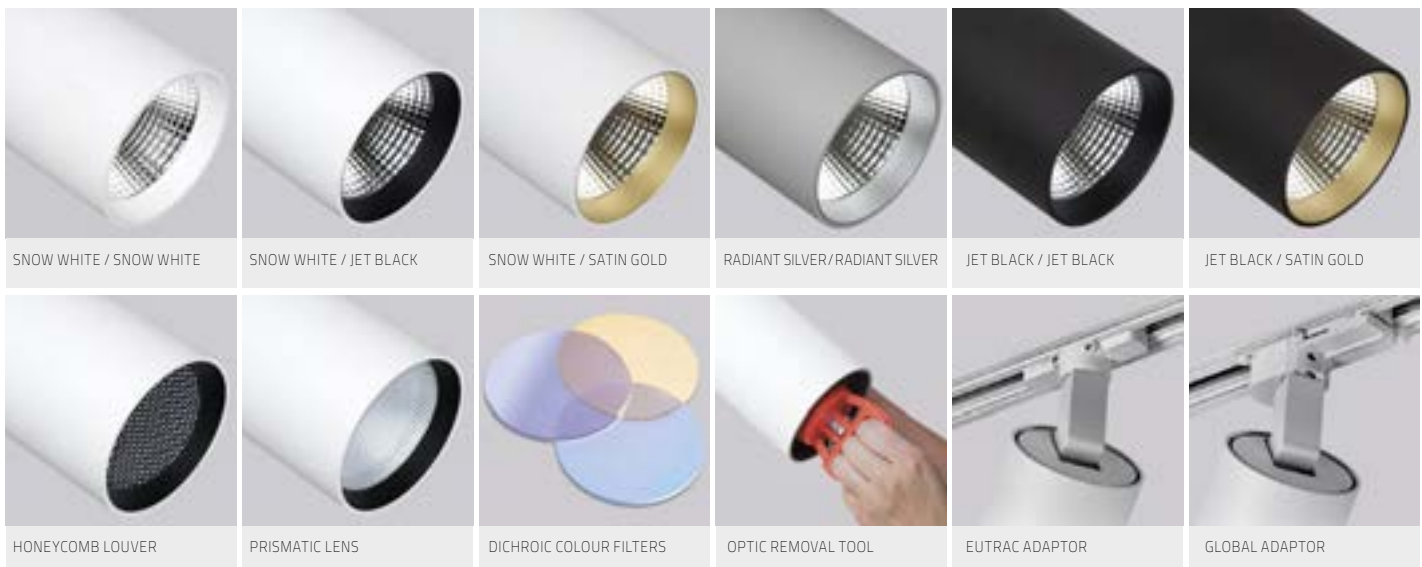

BASIC DÉCO  
3-PHASE TRACK | C3



**DE** LED-Strahler für 3-Phasen-Stromschienen. 350° drehbar und 90° schwenkbar. Leuchtenkörper aus Aluminiumprofil mit Bauhöhe 58mm. Gehäuse-Außenfläche und dekorativer Reflektorring in unterschiedlichen Lackierungen und Kombinationen erhältlich, z.B. weiß, silber, graphit, schwarz, gold oder kupferfarben. Zu Oberflächenoptionen- und Kombinationen siehe Lightnet-Surface-Collection oder Bi-Colour-Auswahl. Rückversetzte Microprismenoptik mit optimierter Blendungsbegrenzung speziell für Office-Anwendungen. Satinierter Opaldiffusor für Allgemeinbeleuchtung mit max. Transmissionsgrad und homogener Lichtpunktauflösung. Konverter in Leuchtengehäuse integriert, wahlweise einfach schaltbar oder stufenlos dimmbar (DALI). Farbtemperaturen 2200K, 2700K, 3000K, 3500K, 4000K oder 6500K. Binning initial  $\leq$  MacAdam 3. Colour rendering CRI>80 oder CRI>90. 3-Phasen-Schienenadapter wahlweise Global oder Eutrac.

**EN** LED spotlight for 3-phase tracks. 350° rotatable and 90° tiltable. Luminaire body made of aluminium profile with overall height of 58mm. Outer housing and decorative reflector ring available in various finishes and combinations, e.g. white, silver, graphite, black, gold or copper coated. For surface options and combinations check Lightnet Surface Collection or Bi-Colour Selection. Recessed Microprismatic with optimized glare reduction especially for workplaces. Satin opal diffuser for general lighting with maximum transmittance and homogeneous lighting. Driver integrated into luminaire housing, optionally switchable or dimmable (DALI). Colour temperatures 2200K, 2700K, 3000K, 3500K, 4000K or 6500K. Binning initial  $\leq$  MacAdam 3. Colour rendering CRI>80 or CRI>90. 3-phase rack adapter optionally EUTRAC or GLOBAL.

**FR** Projecteur LED pour système à 3 phases. Orientable à 350° et pivotant à 90°. Corps du luminaire en profilé aluminium avec une hauteur de 58mm. Surface du luminaire et réflecteur/bague décorative disponible en différentes combinaisons et couleurs au choix, Ex: blanc, argent, graphite, noir ou cuivre. Pour les options et combinaisons de finitions, voir Lightnet Surface Collection ou Bi-Colour Selection. Diffuseur microprismatique encastré avec réduction optimisée de l'éblouissement, spécialement pour les postes de travail. Diffuseur opale satiné pour un éclairage général et une transmission maximale et homogène. Driver intégré dans le luminaire, au choix ON/OFF ou graduable (DALI). Température de couleur 2200K, 2700K, 3000K, 3500K, 4000K ou 6500K. Binning initial  $\leq$  MacAdam 3. Rendu de couleur CRI>80 ou CRI>90. Adaptateur de rail triphasé au choix EUTRAC ou GLOBAL.



**PRODUCT-CODE:** B C3 O S E - 8 30 M - D300 - E S

PRODUCT FAMILY	- B: Basic
TYPE	- C3: Direct Only, tiltable
OPTICAL SYSTEM	- A: Microprismatic, O: Opal
SURFACE FINISH	- W: Snow White, V: Ivory White, S: Radiant Silver, U: Urban Graphite, B: Jet Black, H: Champagne Silver, K: Satin Copper
CONTROL GEAR	- E: On/Off, L: DALI
COLOUR REND.	- 8: CRI>80, 9: CRI>90, F: Full Spectrum
COLOUR TEMP.	- 22: 2200K, 27: 2700K, 30: 3000K, 35: 3500K, 40: 4000K, 65: 6500K
POWER	- M: Medium Power, H: High Power
SIZE	- Luminaire Diameter in mm: D300
ADAPTOR	- G: Global Adaptor, E: Eutrac Adaptor
REFLECTOR	- W: Snow White, V: Ivory White, S: Radiant Silver, U: Urban Graphite, B: Jet Black, H: Champagne Silver, K: Satin Copper, G: Satin Gold

MICROPRISMATIC | DIRECT

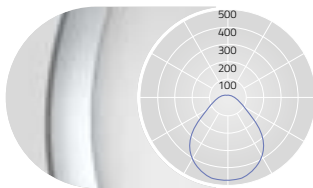

UGR<sub>s19</sub> for Medium Power (X=4H, Y=8H, S=0.25H)  
DIRECT: 100%

OPAL DIFFUSER | DIRECT



DIRECT: 100%

D mm	Lumen/Watt Medium Power	Lumen/Watt High Power
300	920lm/8W	1590lm/13W

D mm	Lumen/Watt Medium Power	Lumen/Watt High Power
300	900lm/8W	1560lm/13W



Lumen Values: Luminaire luminous flux at 4000K/CRI>80. Other configurations on request.





CUBIC EVOLUTION  
3-PHASE TRACK | C4



**DE** LED-Anbauleuchte. Direktstrahlend. Leuchtenkörper in minimalistischer Bauhöhe aus Aluminiumprofil. Oberfläche natureloxiert oder weiß, graphit, schwarz bzw. champagnerfarben lackiert sowie Alu poliert. Weitere Oberflächenoptionen siehe Lightnet-Surface-Collection oder RAL nach Wahl. Microprismenoptik mit optimierter Blendungsbegrenzung speziell für Office-Anwendungen. Satinierter Opaldiffusor für Allgemeinbeleuchtung mit max. Transmissionsgrad und homogener Lichtpunktauflösung. Konverter in Leuchtengehäuse integriert, wahlweise einfach schaltbar oder stufenlos dimmbar (DALI). Farbtemperaturen 2700K, 3000K, 3500K oder 4000K. Binning initial  $\leq$  MacAdam 3. Farbwiedergabe CRI>80 oder CRI>90. Adapter für 3-Phasen Stromschienen wahlweise Global oder Eutrac. Auf Anfrage: Multisensor sowie Integration von Notlichtkomponenten.

**EN** LED surface-mounted luminaire. Direct only light distribution. Luminaire body with minimalistic overall height made of aluminium profile. Surface natural anodised or white, graphite, black or champagne coated as well as polished aluminium. Further surface options see Lightnet-Surface-Collection or RAL of your choice. Microprismatic with optimized glare reduction especially for workplaces. Satin opal diffuser for general lighting with maximum transmittance and homogeneous lighting. Driver integrated into luminaire housing, optionally switchable or dimmable (DALI). Colour temperature 2700K, 3000K, 3500K or 4000K. Binning initial  $\leq$  MacAdam 3. Colour rendering CRI>80 or CRI>90. Adapter for 3-phase tracks optionally Global or Eutrac. On request: Multi-sensor, integration of emergency lighting components.

**FR** Luminaire LED en saillie. Éclairage seulement direct. Corps du luminaire en profilé aluminium et épaisseur minimaliste. Surface anodisée ou laquée blanc, graphite, noir, champagne ou polie. Autres options de finition voir Lightnet-Surface-Collection ou RAL au choix. Diffuseur microprismatique optimisé pour un éblouissement limité et adapté aux bureaux. Diffuseur opale satiné pour un éclairage général et une transmission maximale et homogène. Driver intégré dans le luminaire, au choix ON/OFF ou graduable (DALI). Température de couleur 2700K, 3000K, 3500K ou 4000K. Binning initial  $\leq$  MacAdam 3. Rendu de couleur CRI>80 ou CRI>90. Adaptateur de rail triphasé au choix EUTRAC ou GLOBAL. Sur demande: Multisensor et intégration de composants d'éclairage de secours.



PRODUCT-CODE:	C C4 A B E - 8 30 M - L900 - G
PRODUCT FAMILY	- C: Cubic
TYPE	- C4: Direct Only
OPTICAL SYSTEM	- A: Microprismatic, O: Opal Diffuser
SURFACE FINISH	- W: Snow White, E: Silver Anodised, U: Urban Graphite, B: Jet Black, H: Champagne Silver, P: Polished Aluminum
CONTROL GEAR	- E: On/Off, L: DALI
COLOUR REND.	- 8: CRI>80, 9: CRI>90, F: Full Spectrum
COLOUR TEMP.	- 27: 2700K, 30: 3000K, 35: 3500K, 40: 4000K
POWER	- M: Medium Power, H: High Power
SIZE	- Luminaire Length in mm L900, L1200, L1500
ADAPTOR	- G: Global Adaptor, E: Eutrac Adaptor
ON REQUEST	- Emergency Module, Multisensor



MICROPRISMATIC | DIRECT



UGRs<sub>19</sub> for Medium Power (X=4H, Y=8H, S=0.25H)  
DIRECT: 100%

OPAL DIFFUSER | DIRECT

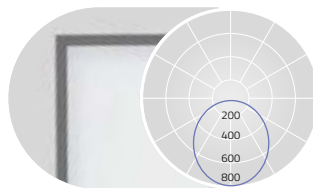

DIRECT: 100%

L mm	Lumen/Watt Medium Power	Lumen/Watt High Power
900	2330lm/19W	2990lm/26W
1200	2960lm/26W	3800lm/33W
1500	3640lm/32W	4630lm/41W

L mm	Lumen/Watt Medium Power	Lumen/Watt High Power
900	2120lm/19W	2710lm/26W
1200	2790lm/26W	3550lm/33W
1500	3350lm/32W	4260lm/41W

Lumen Values: Luminaire luminous flux at 4000K/CRI>80. Other configurations on request.



MULTISENSOR CONTROL

EMERGENCY MODULE



SNOW WHITE

SILVER ANODISED

URBAN GRAPHITE

JET BLACK

CHAMPAGNE SILVER

POLISHED ALUMINUM

MATRIC 38<sub>MM</sub> LENS LOUVER  
3-PHASE TRACK | C1



**DE** LED-Anbauleuchte für 3-Phasen-Stromschienen. Rein direktstrahlend. Lichtkanal aus Aluminiumprofil mit 38mm Lichtspur-Breite. Millimetergenaue Längenfertigung nach Vorgabe möglich. Oberfläche natureloxiert oder weiß, graphit, schwarz, champagner oder kupferfarben lackiert. Weitere Oberflächenoptionen siehe Lightnet-Surface-Collection oder RAL nach Wahl. Präzisionslinsen mit Abblenderaster für breite rotationssymmetrische Lichtstärkeverteilung bei gleichzeitig hoher Blendungsbegrenzung (UGR<16). Raster in verschiedenen Farbausführung erhältlich. Konverter in Leuchtengehäuse integriert, wahlweise einfach schaltbar oder stufenlos dimmbar (DALI). Farbtemperaturen 2700K, 3000K oder 4000K. Binning initial ≤ MacAdam 3. Farbwiedergabe CRI>80. Stromschienenadapter wahlweise EUTRAC oder GLOBAL.

**EN** LED surface-mounted luminaire for 3-phase tracks. Direct only light distribution. Light channel made of aluminium profile with 38mm profile width. Precise length production according to specifications possible. Surface natural anodised or white, graphite, black, champagne or copper coated. Further surface options see Lightnet-Surface-Collection or RAL of your choice. Precision lenses with louvre for wide rotationally symmetrical light distribution with high glare limitation (UGR<16). Louvre available in various colour combinations. Driver integrated into luminaire housing, optionally switchable or dimmable (DALI). Colour temperature 2700K, 3000K or 4000K. Binning initial ≤ MacAdam 3. Colour rendering CRI>80. Track adapter optionally EUTRAC or GLOBAL.

**FR** Luminaire LED en saillie pour système à 3 phases. Éclairage seulement direct. Rail lumineux en profilé d'aluminium avec une largeur d'éclairage de 38 mm. Fabrication au millimètre près des longueurs selon les spécifications. Surface anodisée ou laquée blanc, graphite, noir, champagne ou cuivre. Autres options de finition voir Lightnet-Surface-Collection ou RAL au choix. Lentilles de précision avec grille antiéblouissement pour une large répartition symétrique de l'intensité lumineuse et facteur d'antiéblouissement très bas (UGR<16). Grille antiéblouissement disponible en plusieurs combinaisons de couleurs. Driver intégré dans le luminaire, au choix ON/OFF ou graduable (DALI). Température de couleur 2700K, 3000K ou 4000K. Binning initial ≤ MacAdam 3. Rendu de couleur CRI>80. Adaptateur rail 3-Phases au choix EUTRAC ou GLOBAL.

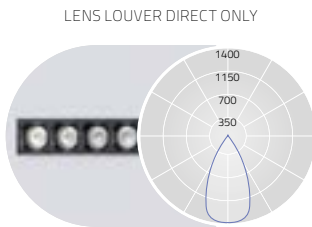
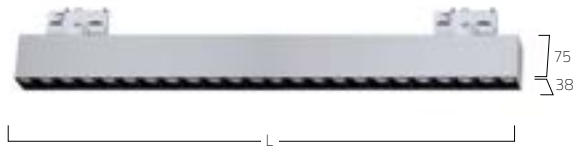

UGR<16 (X=4H, Y=8H, S=0.25H)  
DIRECT: 100%

L mm	Lumen/Watt Low Power	Lumen/Watt Medium Power
669	1260lm/15W	2030lm/24W
953	1800lm/20W	2900lm/33W
1237	2340lm/25W	3770lm/42W
1521	2880lm/31W	4640lm/52W
1805	3420lm/36W	5510lm/61W

**PRODUCT-CODE:** L C1 L E L - 8 30 M - L1521 - E B

- PRODUCT FAMILY: L: Matric
- TYPE: C1: Direct Only
- OPTICAL SYSTEM: L: Lens Louver
- SURFACE FINISH: W: Snow White, V: Ivory White, E: Silver Anodised, U: Urban Graphite, B: Jet Black, H: Champagne Silver, K: Satin Copper, A: Satin Silver
- CONTROL GEAR: E: On/Off, L: DALI
- COLOUR REND.: 8: CRI>80
- COLOUR TEMP.: 27: 2700K, 30: 3000K, 40: 4000K
- POWER: E: Low Power, M: Medium Power
- SIZE: Luminaire length in mm: L669, L953, L1237, L1521, L1805
- ADAPTOR: G: Global Adaptor, E: Eutrac Adaptor
- REFLECTOR: W: Snow White, C: Specular Chrome, B: Jet Black, A: Satin Silver, H: Champagne Silver, K: Satin Copper, N: Satin Platinum, G: Satin Gold



MATRIC 38<sub>MM</sub>  
3-PHASE TRACK | C1



**DE** LED-Anbauleuchte für 3-Phasen-Stromschienen. Rein direktstrahlend. Lichtkanal aus Aluminiumprofil mit 38mm Lichtspur-Breite. Millimetergenaue Längenfertigung nach Vorgabe möglich. Oberfläche naturel oxiert oder weiß, graphit, schwarz oder champagnerfarben lackiert. Weitere Oberflächenoptionen siehe Lightnet-Surface-Collection oder RAL nach Wahl. Microprismenoptik mit optimierter Blendungsbegrenzung speziell für Office-Anwendungen. Opaldiffusor aus satiniertem Acrylglas sowie Ambientdiffusor rundumstrahlend für Allgemeinbeleuchtung. Wallwasher für homogene vertikale Beleuchtung. Konverter in Leuchtgehäuse integriert, wahlweise einfach schaltbar oder stufenlos dimmbar (DALI). Farbtemperaturen 2200K, 2700K, 3000K, 3500K, 4000K oder 6500K. Binning initial ≤ MacAdam 3. Farbwiedergabe CRI>80 oder CRI>90. Stromschienenadapter wahlweise EUTRAC oder GLOBAL.

**EN** LED surface-mounted luminaire for 3-phase tracks. Direct only light distribution. Light channel made of aluminium profile with 38mm profile width. Precise length production according to specifications possible. Surface natural anodised or white, graphite, black or champagne coated. Further surface options see Lightnet-Surface-Collection or RAL of your choice. Microprismatic with optimized glare reduction especially for workplaces. Opal diffuser made of acrylic glass and ambient diffuser with omnidirectional light distribution for general lighting. Wallwasher for homogeneous vertical illumination. Driver integrated into luminaire housing, optionally switchable or dimmable (DALI). Colour temperatures 2200K, 2700K, 3000K, 3500K, 4000K or 6500K. Binning initial ≤ MacAdam 3. Colour rendering CRI>80 or CRI>90. Track adapter optionally EUTRAC or GLOBAL.

**FR** Luminaire LED en saillie pour système à 3 phases. Éclairage seulement direct. Rail lumineux en profilé d'aluminium avec une largeur d'éclairage de 38 mm. Fabrication au millimètre près des longueurs selon les spécifications. Surface anodisée ou laquée blanc, graphite, noir ou champagne. Autres options de finition voir Lightnet-Surface-Collection ou RAL au choix. Diffuseur microprismatique optimisé pour un éblouissement limité et adapté aux bureaux. Diffuseur opale en verre acrylique satiné et diffuseur ambiant avec répartition lumineuse latérale pour diverses applications d'éclairage. Wallwasher pour un éclairage vertical homogène. Driver intégré dans le luminaire, au choix ON/OFF ou graduable (DALI). Température de couleur 2200K, 2700K, 3000K, 3500K, 4000K ou 6500K. Binning initial ≤ MacAdam 3. Rendu de couleur CRI>80 ou CRI>90. Adaptateur rail 3-Phases au choix EUTRAC ou GLOBAL.

MICROPRISMATIC PLUS, MICROPRISMATIC, OPAL, WALLWASHER :



**PRODUCT-CODE:** L C1 A E E - 8 30 M - L890 - G

PRODUCT FAMILY	- L: Matrix
TYPE	- C1: Direct Only
OPTICAL SYSTEM	- H: Microprismatic Plus, A: Microprismatic, O: Opal, F: Ambient, G: Wallwasher
SURFACE FINISH	- W: Snow White, E: Silver Anodised, U: Urban Graphite, B: Jet Black, H: Champagne Silver, K: Satin Copper
CONTROL GEAR	- E: On/Off, L: DALI
COLOUR REND.	- 8: CRI>80, 9: CRI>90, F: Full Spectrum
COLOUR TEMP.	- 22: 2200K, 27: 2700K, 30: 3000K, 35: 3500K, 40: 4000K, 65: 6500K
POWER	- M: Medium Power, H: High Power
SIZE	- Luminaire length in mm: L890, L1182, L1475, L1765, L2055
ADAPTOR	- G: Global Adaptor, E: Eutrac Adaptor

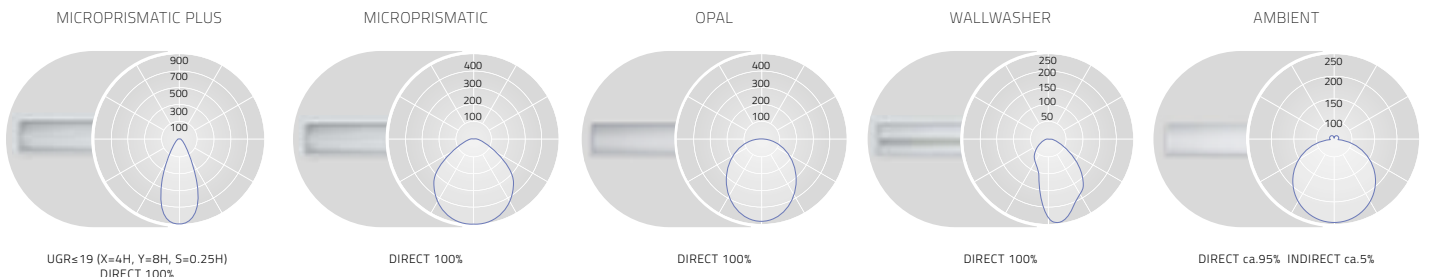

L mm	Lumen/Watt Medium Power	L mm	Lumen/Watt Medium Power	Lumen/Watt High Power	L mm	Lumen/Watt Medium Power	Lumen/Watt High Power	L mm	Lumen/Watt Medium Power	Lumen/Watt High Power	L mm	Lumen/Watt Medium Power	Lumen/Watt High Power
890	1240lm/12W	890	1260lm/13W	1700lm/17W	890	1350lm/13W	1830lm/17W	890	1310lm/13W	1780lm/17W	890	1710lm/13W	2310lm/17W
1182	1650lm/15W	1182	1680lm/16W	2270lm/22W	1182	1810lm/16W	2440lm/22W	1182	1750lm/16W	2370lm/22W	1182	2280lm/16W	3080lm/22W
1475	2060lm/17W	1475	2100lm/20W	2840lm/26W	1475	2260lm/20W	3050lm/26W	1475	2190lm/20W	2960lm/26W	1475	2850lm/20W	3850lm/26W
1765	2480lm/20W	1765	2520lm/23W	3400lm/31W	1765	2710lm/23W	3660lm/31W	1765	2630lm/23W	3550lm/31W	1765	3420lm/23W	4620lm/31W
2055	2880lm/23W	2055	2940lm/26W	3970lm/35W	2055	3160lm/26W	4270lm/35W	2055	3070lm/26W	4140lm/35W	2055	3990lm/26W	5390lm/35W

Lumen Values: Luminaire luminous flux at 4000K/CRI>80. Other configurations on request.



# 3-PHASE TRACKS



**DE** 3-Phasen-Stromschienen für Einbau-, Anbau- oder Pendelmontage. Kompatibel mit allen Leuchten mit GLOBAL-Adaptern. Oberfläche weiß oder schwarz lackiert. Wahlweise in Ausführung schaltbar oder stufenlos dimmbar (DALI). Maximale Systemflexibilität durch umfangreiches Standardsortiment an Verbindern, Abhängungen sowie Zuschnitt nach Maß. Auf Anfrage: gebogene Elemente mit Mindestradius 2500mm.

**EN** 3-phase tracks for recessed, surface or pendant mounting. Compatible with all luminaires with GLOBAL adapters. Surface white or black coated. Optionally switchable or dimmable version (DALI). Maximum system flexibility due to extensive standard range of connectors, suspensions and custom-made lengths. On request: bent elements with a minimum radius of 2500mm.

**FR** Rails triphasés pour un montage encastré, apparent ou suspendu. Compatible avec tous les luminaires équipés d'adaptateurs GLOBAL. Surface laquée blanc ou noir. Au choix ON/OFF ou gradable (DALI). Flexibilité maximale grâce à une vaste gamme de connecteurs, de suspensions et de longueurs sur mesure. Sur demande: éléments cintrés avec un rayon minimum de 2500mm.



**TRACK SURFACE (for Global Adaptor):**

X-HV-TRACK-L2000-E-A-B [ON/OFF, BLACK]  
 X-HV-TRACK-L2000-E-A-W [ON/OFF, WHITE]  
 X-HV-TRACK-L2000-L-A-B [DALI, BLACK]  
 X-HV-TRACK-L2000-L-A-W [DALI, WHITE]



**TRACK RECESSED (for Global Adaptor):**

X-HV-TRACK-L2000-E-L-B [ON/OFF, BLACK]  
 X-HV-TRACK-L2000-E-L-W [ON/OFF, WHITE]  
 X-HV-TRACK-L2000-L-L-B [DALI, BLACK]  
 X-HV-TRACK-L2000-L-L-W [DALI, WHITE]



**END CAP SURFACE:**

X-HV-CAP-A-B [SURFACE BLACK]  
 X-HV-CAP-A-W [SURFACE WHITE]



**END CAP RECESSED:**

X-HV-CAP-L-B [RECESSED BLACK]  
 X-HV-CAP-L-W [RECESSED WHITE]



**FEED:**

X-HV-RFEED-B [BLACK RIGHT]  
 X-HV-RFEED-W [WHITE RIGHT]  
 X-HV-LFEED-B [BLACK LEFT]  
 X-HV-LFEED-W [WHITE LEFT]



**STRAIGHT CONNECTOR:**

X-HV-ICOUPLER-B [BLACK]  
 X-HV-ICOUPLER-W [WHITE]



**CORNER CONNECTOR:**

X-HV-LICOUPLER-B [BLACK, INTERNAL EARTH]  
 X-HV-LICOUPLER-W [WHITE, INTERNAL EARTH]  
 X-HV-LECOUPLER-B [BLACK, EXTERNAL EARTH]  
 X-HV-LECOUPLER-W [WHITE, EXTERNAL EARTH]



**FLEX CONNECTOR:**

X-HV-FLEXCOUPLER-B [BLACK]  
 X-HV-FLEXCOUPLER-W [WHITE]



**SUSPENSION SET:**

X-HV-SUSPENSION-1.5M-B [BLACK, LENGTH 1,5M]  
 X-HV-SUSPENSION-1.5M-W [WHITE, LENGTH 1,5M]  
 X-HV-SUSPENSION-4M-B [BLACK, LENGTH 4M]  
 X-HV-SUSPENSION-4M-W [WHITE, LENGTH 4M]





LUCILLE  
TABLE | T1 50



LUCILLE  
TABLE | T2 52



CUBIC EVOLUTION  
TABLE | T4 54



MATRIC 38MM LENS LOUVER  
TABLE | T1 56



MATRIC 38MM LENS LOUVER  
TABLE | T2 58



MATRIC 38MM LENS LOUVER  
TABLE | T3/T4 60



MATRIC 38MM LENS LOUVER  
TABLE | T5 62

☐ TISCH | TABLE | TABLE

LUCILLE  
TABLE | T1



**DE** LED-Arbeitsplatzleuchte. Microprismenoptik aus Acrylglas für optimierte Entblendung und Lichtlenkung. Höchstmöglicher Transmissionsgrad für energieeffizientes Arbeiten bei gleichmäßiger Ausleuchtung der relevanten Arbeitsflächen. Minimalistischer Leuchtenkopf mit perfekt homogener und vollflächiger Auflösung der Lichtpunkte. Hochwertiger Pantograf mit Präzisionsgelenken komplett aus Aluminium. Keine sichtbaren Kabel, Federn oder Seile. Oberfläche wahlweise weiß, silber, schwarz oder champagnerfarben lackiert. Intuitive Bedienung über Touchfeld im Leuchtenkopf. Lichtlevel stufenlos dimmbar. Hohe Flexibilität durch Arbeits-Erfassungsbereich bis 1 m. Kippsicherheit auch in Maximalstellung. Standard Farbtemperatur 2700K, 3000K oder 4000K. Binning initial ≤ MacAdam 3. Farbwiedergabe CRI>80, alternativ CRI>90. Wahlweise mit Fußplatte aus Stahl, Tischklammer, Tischaufsatzbefestigung, USM-Haller-Adapter oder – auf Anfrage – mit Sonderbefestigung erhältlich.

**EN** LED task light. Microprismatic made of acrylic glass for optimised glare control and light direction. Highest possible transmittance for energy-efficient working with homogeneous illumination of the relevant work areas. Minimalistic luminaire head with perfect uniform and enhanced light transmission. High-quality pantograph with precision joints completely made of aluminium. No visible cables, springs or cords. Surface available in white, silver, black or champagne coated. Intuitive control via touch control panel in the luminaire head. Light output level continuously dimmable. High flexibility due to operating detection range up to 1 m. Tilt resistance even in maximum position. Standard colour temperature 2700K, 3000K or 4000K. Binning initial ≤ MacAdam 3. Colour rendering CRI>80, alternatively CRI>90. Optionally available with base plate made of steel, table clamp, table top attachment, USM Haller adapter or - upon request - with special attachment.

**FR** Lampe de bureau LED. Diffuseur/optique microprisme en verre acrylique pour un antiéblouissement et contrôle de la lumière optimal. Facteur de transmission le plus élevé possible pour une efficacité énergétique de travail optimale avec un éclairage uniforme du poste de travail/bureau. Tête du luminaire minimaliste avec une distribution parfaitement homogène et sur toute la surface des points lumineux. Pantographe de haute qualité avec articulation de précision complètement en aluminium. Pas de câbles, ressorts ou fils visibles. Surface/ finition thermolaqué au choix en couleur blanc, argent, noir ou champagne. Commande de contrôle intuitive tactile dans la tête du luminaire. Niveau d'éclairement dimmable en continu sans coupures. Haute flexibilité sur la zone de travail grâce à une envergure rotative d'1 mètre de l'articulation multidirectionnelle du luminaire. Température de couleur 2700K, 3000K ou 4000K. Binning initial ≤ MacAdam 3. Indice du rendu de couleur IRC>80, alternative IRC>90. Au choix avec pied/base en acier, pince pour table, plaque/kit de fixation pour table, Adaptateur USM-Haller ou disponible avec fixation spéciale sur-mesure sur demande.



**PRODUCT-CODE:** **U T 1 A B S - 8 30 M - D150 - G**

PRODUCT FAMILY	- U Lucille
TYPE	- T1: Table Version [Two Arms]
OPTICAL SYSTEM	- A Microprismatic
SURFACE FINISH	- V Ivory White, A Satin Silver, B Jet Black, H Champagne Silver
CONTROL GEAR	- S Switch & Dim
COLOUR REND.	- 8 CRI>80, 9 CRI>90
COLOUR TEMP.	- 27 2700K, 30 3000K, 40 4000K
POWER	- M: Medium Power
SIZE	- D150: Head Diameter 150 mm
BASE	- G: Table Base, T: Table Clamp, R: Table Grommet, A: USM Haller Adaptor



MICROPRISMATIC | DIRECT

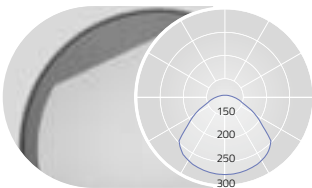

DIRECT: 100%

Lumen/Watt  
Medium Power

750lm/14W

Lumen Values: Luminaire luminous flux at 4000K/CRI>80. Other configurations on request.



LUCILLE  
TABLE | T2



**DE** LED-Arbeitsplatzleuchte. Microprismenoptik aus Acrylglas für optimierte Entblendung und Lichtlenkung. Höchstmöglicher Transmissionsgrad für energieeffizientes Arbeiten bei gleichmäßiger Ausleuchtung der relevanten Arbeitsflächen. Minimalistischer Leuchtenkopf mit perfekt homogener und vollflächiger Auflösung der Lichtpunkte. Präzisionsgelenke komplett aus Aluminium. Keine sichtbaren Kabel, Federn oder Seile. Oberfläche wahlweise weiß, silber, schwarz oder champagnerfarben lackiert. Intuitive Bedienung über Touchfeld im Leuchtenkopf. Lichtlevel stufenlos dimmbar. Standard Farbtemperatur 2700K, 3000K oder 4000K. Binning initial  $\leq$  MacAdam 3. Farbwiedergabe CRI>80, alternativ CRI>90. Wahlweise mit Fußplatte aus Stahl, Tischklammer, Tischaufsatzbefestigung, USM-Haller-Adapter oder – auf Anfrage – mit Sonderbefestigung erhältlich.

**EN** LED task light. Microprismatic made of acrylic glass for optimised glare control and light direction. Highest possible transmittance for energy-efficient working with homogeneous illumination of the relevant work areas. Minimalistic luminaire head with perfect uniform and enhanced light transmission. Precision joints completely made of aluminium. No visible cables, springs or cords. Surface available in white, silver, black or champagne coated. Intuitive control via touch control panel in the luminaire head. Light output level continuously dimmable. Standard colour temperature 2700K, 3000K or 4000K. Binning initial  $\leq$  MacAdam 3. Colour rendering CRI>80, alternatively CRI>90. Optionally available with base plate made of steel, table clamp, table top attachment, USM Haller adaptor or - upon request - with special attachment.

**FR** Lampe de bureau LED. Diffuseur/optique microprisme en verre acrylique pour un antiéblouissement et contrôle de la lumière optimal. Facteur de transmission le plus élevé possible pour une efficacité énergétique de travail optimale avec un éclairage uniforme du poste de travail/bureau. Tête du luminaire minimaliste avec une distribution parfaitement homogène et sur toute la surface des points lumineux. Articulation très précise complètement en aluminium. Pas de câbles, ressorts ou fils visibles. Surface/finition thermolaqué au choix en couleur blanc, argent, noir ou champagne. Commande de contrôle intuitive tactile dans la tête du luminaire. Niveau d'éclairage dimmable en continu sans coupures. Température de couleur 2700K, 3000K ou 4000K. Binning initial  $\leq$  MacAdam 3. Indice de rendu de couleur IRC>80, alternative IRC>90. Au choix avec pied/base en acier, pince pour table, plaque/kit de fixation pour table, Adaptateur USM-Haller ou disponible avec fixation spéciale sur-mesure sur demande.

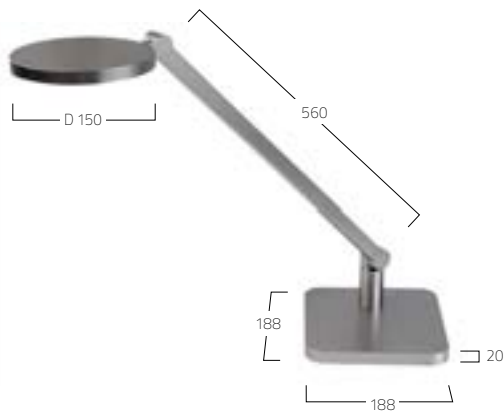

**PRODUCT-CODE: U T 2 A A S - 8 30 M - D150 - G**

PRODUCT FAMILY	- U Lucille
TYPE	- T2 Table Version [One Arm]
OPTICAL SYSTEM	- A Microprismatic
SURFACE FINISH	- V Ivory White, A Satin Silver, B Jet Black, H Champagne Silver
CONTROL GEAR	- S Switch & Dim
COLOUR REND.	- 8 CRI>80, 9 CRI>90
COLOUR TEMP.	- 27: 2700K, 30: 3000K, 40: 4000K
POWER	- M Medium Power
SIZE	- D150 Head Diameter 150 mm
BASE	- G Table Base, T Table Clamp, R Table Grommet, A USM Haller Adaptor



**MICROPRISMATIC | DIRECT**

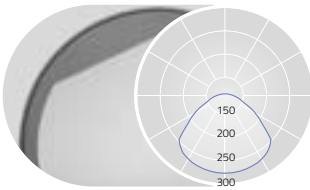

DIRECT: 100%

Lumen/Watt  
Medium Power

750lm/14W

Lumen Values: Luminaire luminous flux at 4000K/CRI>80. Other configurations on request.



# CUBIC EVOLUTION TABLE | T4



**DE** LED-Arbeitsplatzleuchte. Direkt-indirektstrahlend. Leuchtenkörper in minimalistischer Bauhöhe aus Aluminiumprofil. Oberfläche natureloxiert oder weiß, graphit, schwarz bzw. champagnerfarben lackiert sowie Alu poliert. Weitere Oberflächenoptionen siehe Lightnet-Surface-Collection oder RAL nach Wahl. Microprismenoptik mit optimierter Blendungsbegrenzung speziell für Office-Anwendungen. Leuchtenkopf wahlweise in zwei unterschiedlichen Ausrichtungen (left/right) mit vollständiger Auflösung der Lichtpunkte. Intuitives Bedienfeld im Leuchtenmast für stufenlose Dimmung oder einfache Schaltung, alternativ weitgehend autarke Steuerung über modernste Sensortechnologie. Farbtemperatur 3000K, 3500K oder 4000K. Binning initial  $\leq$  MacAdam 3. Farbwiedergabe CRI>80 oder CRI>90. Tischbefestigung wahlweise als Klammer oder Grommet-Aufsatz.

**EN** LED task light. Direct-indirect light distribution. Luminaire body with minimalist overall height made of aluminium profile. Surface natural anodised or white, graphite, black or champagne coated as well as polished aluminium. Further surface options see Lightnet-Surface-Collection or RAL of your choice. Microprismatic screen with optimized glare reduction especially for workplaces. Luminaire head available in two different directions (left/right) with perfect uniform and enhanced light transmission. Intuitive control panel in luminaire pole for dimming or switching, alternatively mostly self-sufficient control via state-of-the-art sensor technology. Colour temperature 3000K, 3500K or 4000K. Binning initial  $\leq$  MacAdam 3. Colour rendering CRI>80 or CRI>90. Table attachment available as clamp or Grommet.

**FR** Lampe de bureau LED. Éclairage direct/indirect. Corps du luminaire en profilé aluminium et épaisseur minimaliste. Surface anodisée ou laquée blanc, graphite, noir, champagne ou polie. Autres options de finition voir Lightnet-Surface-Collection ou RAL au choix. Diffuseur microprismatique optimisé pour un éblouissement limité et adapté aux bureaux. Tête du luminaire disponible dans deux directions différentes (gauche/droite) avec une transmission lumineuse parfaitement uniforme. Panneau de commande intuitif sur le pôle du luminaire pour graduer ou ON/OFF, ou alors en grande partie autonome grâce à une technologie de capteurs ultramoderne. Température de couleur 3000K, 3500K ou 4000K. Binning initial  $\leq$  MacAdam 3. Rendu de couleur CRI>80 ou CRI>90. Fixation de table disponible sous forme de pince ou grommet.



**PRODUCT-CODE:** **C T4 A B S - 8 30 M - L600 - T L**

PRODUCT FAMILY	- C. Cubic
TYPE	- T4. Table
OPTICAL SYSTEM	- A. Microprismatic
SURFACE FINISH	- W. Snow White, E. Silver Anodised, U. Urban Graphite, B. Jet Black, H. Champagne Silver, P. Polished Aluminum
CONTROL GEAR	- S. Switch & Dim, M. Multisensor Control
COLOUR REND.	- 8. CRI>80, 9. CRI>90, F. Full Spectrum
COLOUR TEMP.	- 30. 3000K, 35. 3500K, 40. 4000K
POWER	- M. Medium Power
SIZE	- L600. Head Length in mm
BASE	- R. Table Grommet, T. Table Clamp
VERSION	- L. Left, R. Right



MICROPRISMATIC | DIRECT-INDIRECT

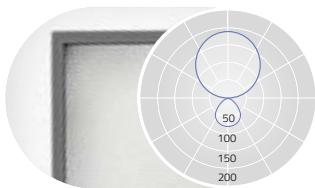

UGR $\leq$ 19 (X=4H, Y=8H, S=0.25H)  
DIRECT: ca.15% INDIRECT ca.85%

L mm	Lumen/Watt Medium Power
600	5750lm/44W

Lumen Values: Luminaire luminous flux at 4000K/CRI>80. Other configurations on request.



MULTISENSOR CONTROL

SWITCH & DIM

TABLE CLAMP

TABLE GROMMET



SNOW WHITE

SILVER ANODISED

URBAN GRAPHITE

JET BLACK

CHAMPAGNE SILVER

POLISHED ALUMINUM



# MATRIC 38<sub>MM</sub> LENS LOUVER TABLE | T1



**DE** LED-Arbeitsplatzleuchte. Rein direktstrahlend. Leuchtenkörper aus Aluminiumprofil. Oberfläche weiß, silber, graphit, schwarz, champagner oder kupferfarben lackiert. Weitere Oberflächenoptionen siehe Lightnet-Surface-Collection oder RAL nach Wahl. Präzisionslinsen mit Abblenderaster für breite rotationssymmetrische Lichtstärkeverteilung bei gleichzeitig hoher Blendungsbegrenzung (UGR<16). Raster in verschiedenen Farbkombinationen erhältlich. Stufenlos dimmbar und schaltbar am Leuchtenschaft. Farbtemperatur 2700K, 3000K oder 4000K. Binning initial ≤ MacAdam 3. Colour rendering CRI>80.

**EN** LED task light. Direct only light distribution. Luminaire body made of aluminum profile. Surface white, silver, graphite, black, champagne or copper coated. Further surface options see Lightnet-Surface-Collection or RAL of your choice. Precision lenses with louvre for wide rotationally symmetrical light distribution with high glare limitation (UGR<16). Louvre available in various colour combinations. Dimmable and switchable at the luminaire shaft. Colour temperature 2700K, 3000K or 4000K. Binning initial ≤ MacAdam 3. Colour rendering CRI>80.

**FR** Lampe de bureau LED. Éclairage seulement direct. Corps du luminaire en profilé aluminium. Surface laquée blanc, argent, graphite, noir, champagne ou cuivre. Autres options de finition voir Lightnet-Surface-Collection ou RAL au choix. Lentilles de précision avec grille anti-éblouissement pour une large répartition symétrique de l'intensité lumineuse et facteur d'anti-éblouissement très bas (UGR<16). Grille anti-éblouissement disponible en plusieurs combinaisons de couleurs. Graduable en continu sans coupures et allumage sur la gaine du luminaire. Température de couleur 2700K, 3000K ou 4000K. Binning initial ≤ MacAdam 3. Rendu de couleur CRI>80.

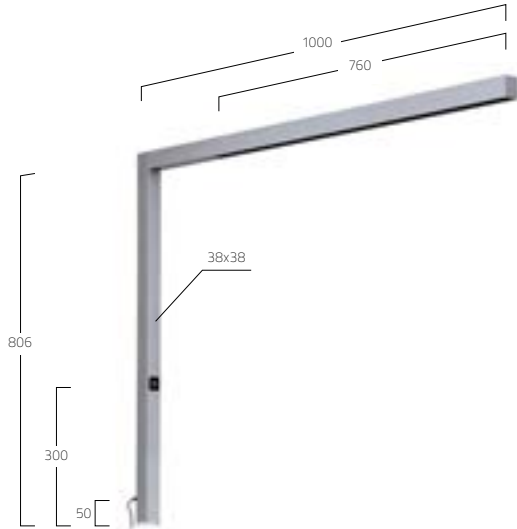

**PRODUCT-CODE: L T1 L S S - 8 30 M - L1000 - R B**

PRODUCT FAMILY	L: Matric
TYPE	T1: Table Version
OPTICAL SYSTEM	L: Lens Louver
SURFACE FINISH	W: Snow White, V: Ivory White, S: Radiant Silver,
	U: Urban Graphite, B: Jet Black, H: Champagne Silver, K: Satin Copper, A: Satin Silver
CONTROL GEAR	S: Switch & Dim
COLOUR REND.	8: CRI>80
COLOUR TEMP.	27: 2700K, 30: 3000K, 40: 4000K
POWER	M: Medium Power
SIZE	L1000: Length in mm
BASE	G: Table Base, T: Table Clamp, R: Table Grommet
REFLECTOR	W: Snow White, C: Specular Chrome, B: Jet Black, A: Satin Silver,
	H: Champagne Silver, K: Satin Copper, G: Satin Gold, N: Satin Platinum



LENS LOUVER | DIRECT

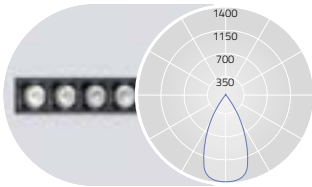

UGR<16 (X=4H, Y=8H, S=0.25H)  
DIRECT: 100%

L mm	Lumen/Watt Medium Power
1000	1750lm/20W

Lumen Values: Luminaire luminous flux at 4000K/CRI>80. Other configurations on request.



# MATRIC 38<sub>MM</sub> LENS LOUVER TABLE | T2



**DE** LED-Arbeitsplatzleuchte. Rein direktstrahlend. Leuchtenkörper aus Aluminiumprofil. Oberfläche weiß, silber, graphit, schwarz, champagner oder kupferfarben lackiert. Weitere Oberflächenoptionen siehe Lightnet-Surface-Collection oder RAL nach Wahl. Präzisionslinsen mit Abblenderaster für breite rotationssymmetrische Lichtstärkeverteilung bei gleichzeitig hoher Blendungsbegrenzung (UGR<16). Raster in verschiedenen Farbkombinationen erhältlich. Stufenlos dimmbar und schaltbar am Leuchtenschaft. Farbtemperatur 2700K, 3000K oder 4000K. Binning initial  $\leq$  MacAdam 3. Colour rendering CRI>80.

**EN** LED task light. Direct only light distribution. Luminaire body made of aluminum profile. Surface white, silver, graphite, black, champagne or copper coated. Further surface options see Lightnet-Surface-Collection or RAL of your choice. Precision lenses with louvre for wide rotationally symmetrical light distribution with high glare limitation (UGR<16). Louvre available in various colour combinations. Dimmable and switchable at the luminaire shaft. Colour temperature 2700K, 3000K or 4000K. Binning initial  $\leq$  MacAdam 3. Colour rendering CRI>80.

**FR** Lampe de bureau LED. Éclairage seulement direct. Corps du luminaire en profilé aluminium. Surface laquée blanc, argent, graphite, noir, champagne ou cuivre. Autres options de finition voir Lightnet-Surface-Collection ou RAL au choix. Lentilles de précision avec grille anti-éblouissement pour une large répartition symétrique de l'intensité lumineuse et facteur d'anti-éblouissement très bas (UGR<16). Grille anti-éblouissement disponible en plusieurs combinaisons de couleurs. Graduable en continu sans coupures et allumage sur la gaine du luminaire. Température de couleur 2700K, 3000K ou 4000K. Binning initial  $\leq$  MacAdam 3. Rendu de couleur CRI>80.

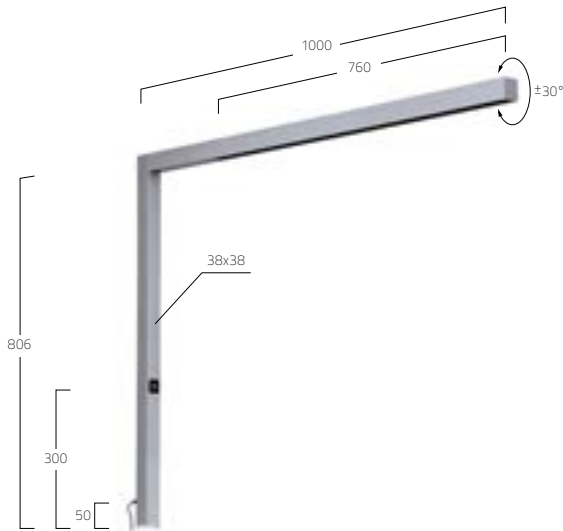

**PRODUCT-CODE: L T2 L S S - 8 30 M - L1000 - R B**

PRODUCT FAMILY	L: Matric
TYPE	T2: Table Version
OPTICAL SYSTEM	L: Lens Louver
SURFACE FINISH	W: Snow White, V: Ivory White, S: Radiant Silver,
	U: Urban Graphite, B: Jet Black, H: Champagne Silver, K: Satin Copper, A: Satin Silver
CONTROL GEAR	S: Switch & Dim
COLOUR REND.	8: CRI>80
COLOUR TEMP.	27: 2700K, 30: 3000K, 40: 4000K
POWER	M: Medium Power
SIZE	L1000: Length in mm
BASE	G: Table Base, T: Table Clamp, R: Table Grommet
REFLECTOR	W: Snow White, C: Specular Chrome, B: Jet Black, A: Satin Silver,
	H: Champagne Silver, K: Satin Copper, G: Satin Gold, N: Satin Platinum



LENS LOUVER | DIRECT

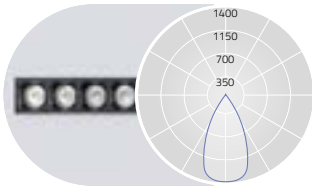

UGR<16 (X=4H, Y=8H, S=0.25H)  
DIRECT: 100%

L mm	Lumen/Watt Medium Power
1000	1750lm/20W



MATRIC 38<sub>MM</sub> LENS LOUVER  
TABLE | T3/T4



**DE** LED-Arbeitsplatzleuchte. Rein direktstrahlend. Leuchtenkörper aus Aluminiumprofil. Leuchtenkopf zur präzisen Ausleuchtung drehbar. Oberfläche weiß, silber, graphit, schwarz, champagner oder kupferfarben lackiert. Weitere Oberflächenoptionen siehe Lightnet-Surface-Collection oder RAL nach Wahl. Präzisionslinsen mit Abblenderaster für breite rotationssymmetrische Lichtstärkeverteilung bei gleichzeitig hoher Blendungsbegrenzung (UGR<16). Louvre in verschiedenen Farbkombinationen erhältlich. Stufenlos dimmbar und schaltbar am Leuchtschaft. Farbtemperatur 2700K, 3000K oder 4000K. Binning initial  $\leq$  MacAdam 3. Farbwiedergabe CRI>80.

**EN** LED task light. Direct only light distribution. Luminaire body made of aluminum profile. Luminaire head rotatable for precise illumination. Surface white, silver, graphite, black, champagne or copper coated. Further surface options see Lightnet-Surface-Collection or RAL of your choice. Precision lenses with louvre for wide rotationally symmetrical light distribution with high glare limitation (UGR<16). Louvre available in various colour combinations. Dimmable and switchable at the luminaire shaft. Colour temperature 2700K, 3000K or 4000K. Binning initial  $\leq$  MacAdam 3. Colour rendering CRI>80.

**FR** Lampe de bureau LED. Éclairage seulement direct. Corps du luminaire en profilé aluminium. Tête du luminaire orientable pour éclairage précis. Surface laquée blanc, argent, graphite, noir, champagne ou cuivre. Autres options de finition voir Lightnet-Surface-Collection ou RAL au choix. Lentilles de précision avec grille antiéblouissement pour une large répartition symétrique de l'intensité lumineuse et facteur d'antiéblouissement très bas (UGR<16). Grille antiéblouissement disponible en plusieurs combinaisons de couleurs. Graduable en continu sans coupures et allumage sur la gaine du luminaire. Température de couleur 2700K, 3000K ou 4000K. Binning initial  $\leq$  MacAdam 3. Rendu de couleur CRI>80.

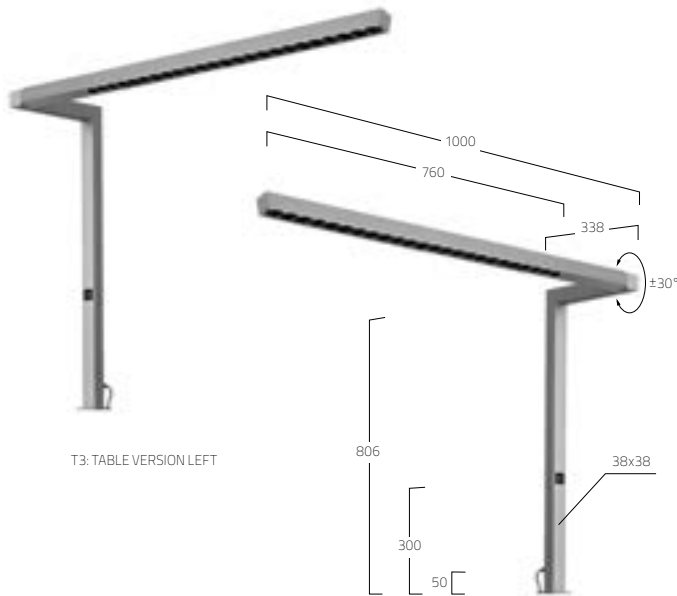

**PRODUCT-CODE:** L T3 L S S - 8 30 M - L1000 - R B

PRODUCT FAMILY	L: Matric
TYPE	T3: Table Version Left, T4: Table Version Right
OPTICAL SYSTEM	L: Lens Louver
SURFACE FINISH	W: Snow White, V: Ivory White, S: Radiant Silver, U: Urban Graphite, B: Jet Black, H: Champagne Silver, K: Satin Copper, A: Satin Silver
CONTROL GEAR	S: Switch & Dim
COLOUR REND.	8: CRI>80
COLOUR TEMP.	27: 2700K, 30: 3000K, 40: 4000K
POWER	M: Medium Power
SIZE	L1000: Length in mm
BASE	G: Table Base, T: Table Clamp, R: Table Grommet
REFLECTOR	W: Snow White, C: Specular Chrome, B: Jet Black, A: Satin Silver, H: Champagne Silver, K: Satin Copper, G: Satin Gold, N: Satin Platinum



LENS LOUVER | DIRECT

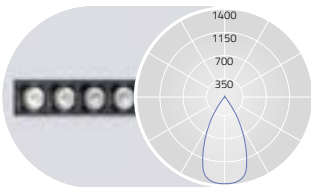

UGR<16 (X=4H, Y=8H, S=0.25H)  
DIRECT: 100%

L mm	Lumen/Watt Medium Power
1000	1750lm/20W

T4: TABLE VERSION RIGHT



# MATRIC 38<sub>MM</sub> LENS LOUVER TABLE | T5



**DE** LED-Arbeitsplatzleuchte. Rein direktstrahlend. Leuchtenkörper aus Aluminiumprofil. Oberfläche weiß, silber, graphit, schwarz, champagner oder kupferfarben lackiert. Weitere Oberflächenoptionen siehe Lightnet-Surface-Collection oder RAL nach Wahl. Präzisionslinsen mit Abblenderaster für breite rotationssymmetrische Lichtstärkeverteilung bei gleichzeitig hoher Blendungsbegrenzung (UGR<16). Raster in verschiedenen Farbkombinationen erhältlich. Stufenlos dimmbar und schaltbar am Leuchtschaft. Farbtemperatur 2700K, 3000K oder 4000K. Binning initial  $\leq$  MacAdam 3. Farbwiedergabe CRI>80.

**EN** LED task light. Direct only light distribution. Luminaire body made of aluminum profile. Surface white, silver, graphite, black, champagne or copper coated. Further surface options see Lightnet-Surface-Collection or RAL of your choice. Precision lenses with louvre for wide rotationally symmetrical light distribution with high glare limitation (UGR<16). Louvre available in various colour combinations. Dimmable and switchable at the luminaire shaft. Colour temperature 2700K, 3000K or 4000K. Binning initial  $\leq$  MacAdam 3. Colour rendering CRI>80.

**FR** Lampe de bureau LED. Éclairage seulement direct. Corps du luminaire en profilé aluminium. Surface laquée blanc, argent, graphite, noir, champagne ou cuivre. Autres options de finition voir Lightnet-Surface-Collection ou RAL au choix. Lentilles de précision avec grille anti-éblouissement pour une large répartition symétrique de l'intensité lumineuse et facteur d'anti-éblouissement très bas (UGR<16). Grille anti-éblouissement disponible en plusieurs combinaisons de couleurs. Graduable en continu sans coupures et allumage sur la gaine du luminaire. Température de couleur 2700K, 3000K ou 4000K. Binning initial  $\leq$  MacAdam 3. Rendu de couleur CRI>80.

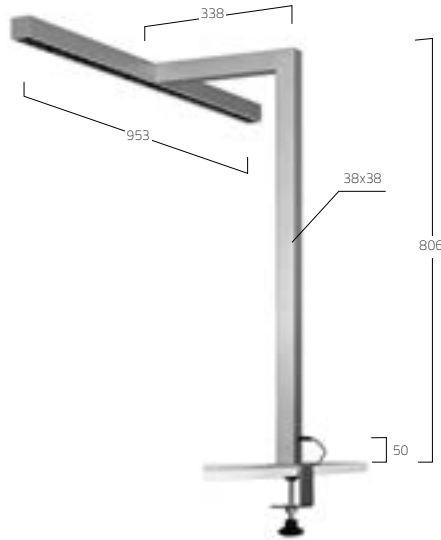

**PRODUCT-CODE:** L T5 L S S - 8 30 M - L953 - R B

PRODUCT FAMILY	L: Matric
TYPE	T5: Table Version
OPTICAL SYSTEM	L: Lens Louver
SURFACE FINISH	W: Snow White, V: Ivory White, S: Radiant Silver, U: Urban Graphite, B: Jet Black, H: Champagne Silver, K: Satin Copper, A: Satin Silver
CONTROL GEAR	S: Switch & Dim
COLOUR REND.	8: CRI>80
COLOUR TEMP.	27: 2700K, 30: 3000K, 40: 4000K
POWER	M: Medium Power
SIZE	L953: Length in mm
BASE	G: Table Base, T: Table Clamp, R: Table Grommet
REFLECTOR	W: Snow White, C: Specular Chrome, B: Jet Black, A: Satin Silver, H: Champagne Silver, K: Satin Copper, G: Satin Gold, N: Satin Platinum



LENS LOUVER | DIRECT

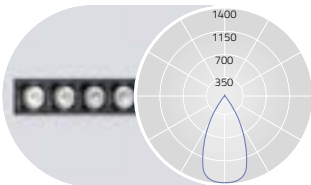

UGR<16 (X=4H, Y=8H, S=0.25H)  
DIRECT: 100%

L mm	Lumen/Watt Medium Power
953	2190lm/24W

Lumen Values: Luminaire luminous flux at 4000K/CRI>80. Other configurations on request.







BASIC NEO FLOOR | F2 70



BASIC NEO FLOOR | F4 72



BASIC DÉCO FLOOR | F3 74



BASIC DÉCO FLOOR | F5 76



BEAM ME UP JR. FLOOR | F3 78



BEAM ME UP JR. FLOOR | F4 80



CUBIC EVOLUTION FLOOR | F2 86



CUBIC EVOLUTION FLOOR | F3 88



CUBIC EVOLUTION FLOOR | F4 90



CUBIC EVOLUTION FLOOR | F5 92



CUBIC EVOLUTION FLOOR | F6 94



CUBIC EVOLUTION FLOOR | F7 96



CUBIC EVOLUTION FLOOR | F8 98



MATRIC 38MM LENS LOUVER FLOOR | F2 102



MATRIC 38MM LENS LOUVER FLOOR | F7 104

I STEH | FLOOR | LAMPADAIRE

# BASIC NEO FLOOR





JOOM OFFICE, MOSCOW, RUSSIA  
BASIC-F4  
ARCHITECT: V12 ARCHITECTS  
PHOTOS: POLINA POLUDKINA

# BASIC NEO FLOOR

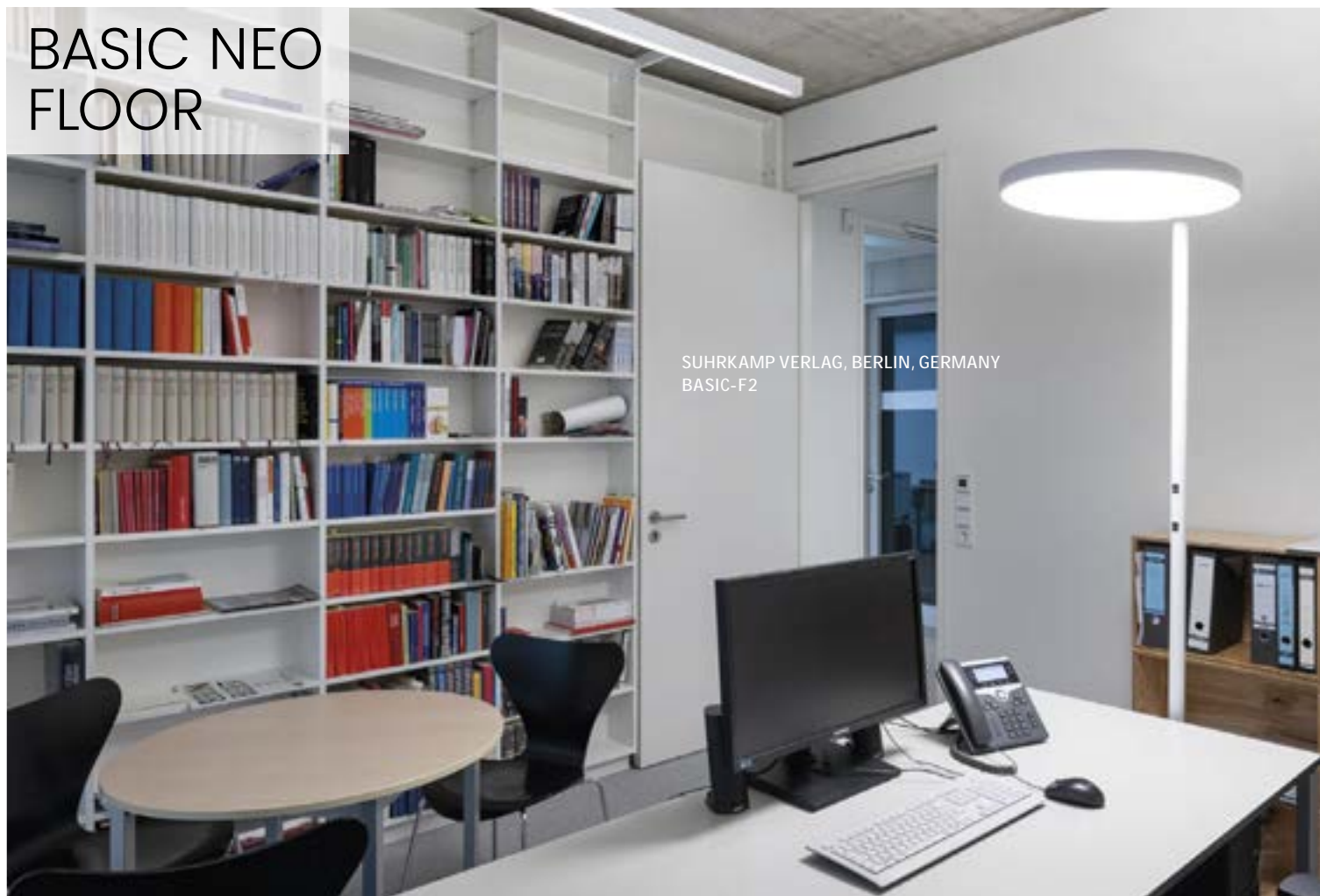

SUHRKAMP VERLAG, BERLIN, GERMANY  
BASIC-F2





SUHRKAMP VERLAG, BERLIN, GERMANY  
BASIC-F4

BASIC NEO  
FLOOR | F2

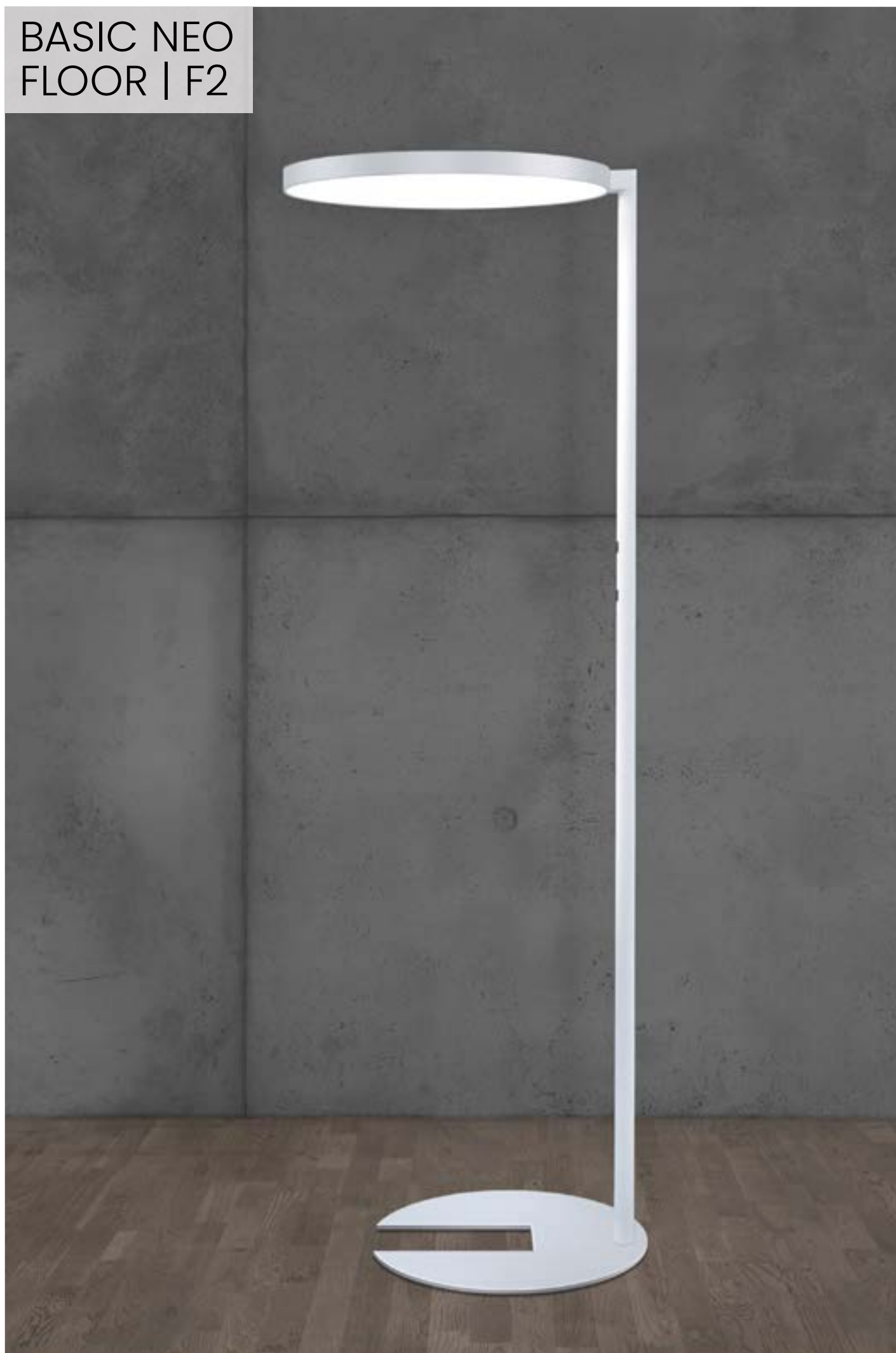

**DE** LED-Stehleuchte. Direkt-indirektstrahlend. Leuchtenkopf aus Aluminiumprofil mit filigraner Bauhöhe von 38mm und Durchmesser 500mm. Oberfläche weiß, silber, graphit, schwarz, champagner oder kupferfarben lackiert. Weitere Oberflächenoptionen siehe Lightnet-Surface-Collection oder RAL nach Wahl. Microprismenoptik für Office Anwendungen. Indirektanteil mit innovativer Linsentechnologie für breitstrahlende Deckenaufhellung. Zwei Taster im Leuchtenmast für getrennt stufenlose Dimmung und Schaltung der Kamern für Direkt-/ Indirektlicht, alternativ gemeinsame Steuerung über modernste Sensor- oder Schwarmtechnologie. Farbtemperaturen 3000K, 3500K oder 4000K. Binning initial  $\leq$  MacAdam 3. Farbwiedergabe CRI>80 oder CRI>90. Runde Fußplatte aus Stahl mit U-Cut-Out Lackierung passend Leuchtenkörper.

**EN** LED free-standing luminaire. Direct-indirect light distribution. Luminaire head made of aluminium profile with filigree overall height of 38mm and diameter of 500mm. Surface white, silver, graphite, black, champagne or copper coated. Further surface options see Lightnet-Surface-Collection or RAL of your choice. Microprismatic for workplaces. Indirect light with innovative lens technology for wide-angle ceiling illumination. 2 pushbuttons in the luminaire pole for dimming and switching the direct/indirect light separately, alternatively combined control via state-of-the-art sensor or swarm technology. Colour temperature 3000K, 3500K or 4000K. Binning initial  $\leq$  MacAdam 3. Colour rendering CRI>80 or CRI>90. Round base plate made of steel with U-Cut-Out, colour matching luminaire body.

**FR** Lampadaire LED. Éclairage direct/indirect. Tête du luminaire en profilé aluminium avec une épaisseur fine de 38mm et diamètre 500mm. Surface laquée blanc, argent, graphite, noir, champagner ou cuivre. Autres options de finition voir Lightnet-Surface-Collection ou RAL au choix. Diffuseur microprismatique adapté aux bureaux. Composants indirects avec une technologie de lentille innovante pour un éclairage grand angle du plafond. Deux boutons-poussoir sur le mât du luminaire pour graduation séparée et allumage indépendant de la partie Directe/Indirecte, alternative de gestion groupée par la technologie moderne de sensor/cellule ou swarm control. Température de couleur 3000K, 3500K ou 4000K. Binning initial  $\leq$  MacAdam 3. Rendu de couleur CRI>80 ou CRI>90. Base ronde fait d'acier en U-Cut-Out, couleur assortie au corps du luminaire.

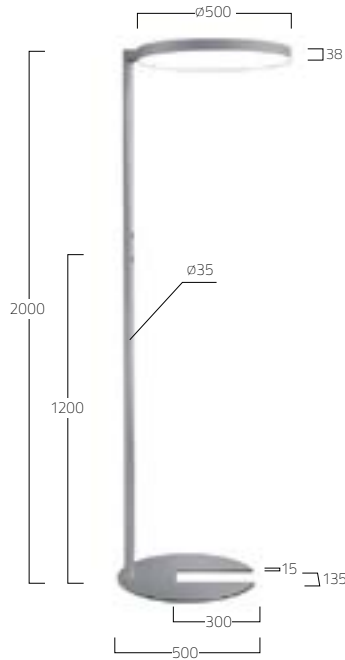

**PRODUCT-CODE:** **B F 2 A S X - 8 30 M - D500 - U**

PRODUCT FAMILY	- B Basic
TYPE	- F2 Floor Direct-Indirect
OPTICAL SYSTEM	- A Microprismatic
SURFACE FINISH	- W: Snow White, V: Ivory White, S: Radiant Silver, U: Urban Graphite, B: Jet Black, H: Champagne Silver, K: Satin Copper
CONTROL GEAR	- X Separately Dimmable, M: Multisensor, R: Swarm Control
COLOUR REND.	- 8: CRI>80, 9: CRI>90
COLOUR TEMP.	- 27: 2700K, 30: 3000K, 35: 3500K, 40: 4000K, TW: Tunable White 2700-6500K
POWER	- M: Medium Power
SIZE	- Luminaire Diameter in mm: D500
BASE	- U: U-Cut-Out



MICROPRISMATIC | DIRECT-INDIRECT



UGR $\leq$ 19 (X=4H, Y=8H, S=0.25H)  
DIRECT: ca.30% INDIRECT ca.70%

D mm	Lumen/Watt Medium Power
500	11710lm/81W

Lumen Values: Luminaire luminous flux at 4000K/CRI>80. Other configurations on request.



MULTISENSOR CONTROL



SNOW WHITE

RADIANT SILVER

URBAN GRAPHITE

JET BLACK

CHAMPAGNE SILVER

SATIN COPPER



BASIC NEO  
FLOOR | F4

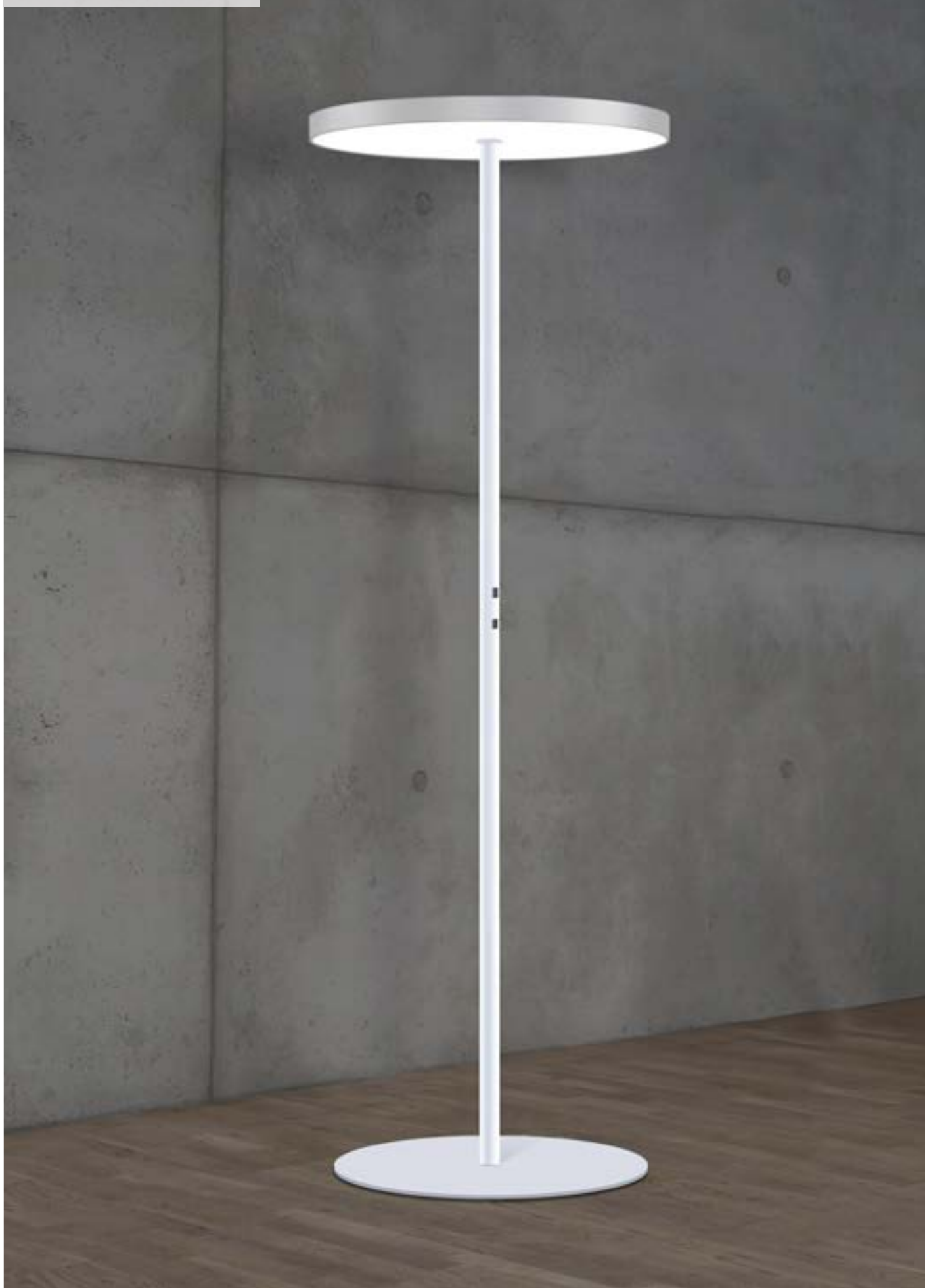

**DE** LED-Stehleuchte. Direkt-indirektstrahlend. Leuchtenkopf aus Aluminiumprofil mit filigraner Bauhöhe von 38mm und Durchmesser 600mm. Oberfläche weiß, silber, graphit, schwarz, titan oder kupferfarben lackiert. Weitere Oberflächenoptionen siehe Lightnet-Surface-Collection oder RAL nach Wahl. Microprismenoptik für Office Anwendungen. Indirektanteil mit innovativer Linsentechnologie für breitstrahlende Deckenaufhellung. Zwei Taster im Leuchtenmast für getrennt stufenlose Dimmung und Schaltung der Kammern für Direkt-/ Indirektlicht. Farbtemperaturen 2700K, 3000K, 3500K oder 4000K. Binning initial  $\leq$  MacAdam 3. Farb wiedergabe CRI>80 oder CRI>90. Runde Fußplatte aus Stahl, Lackierung passend Leuchtenkörper.

**EN** LED free-standing luminaire. Direct-indirect light distribution. Luminaire head made of aluminium profile with filigree overall height of 38mm and diameter of 600mm. Surface white, silver, graphite, black, titanium or copper coated. Further surface options see Lightnet-Surface-Collection or RAL of your choice. Microprismatic for workplaces. Indirect light with innovative lens technology for wide-angle ceiling illumination. 2 pushbuttons in the luminaire pole for dimming and switching the direct/indirect light separately. Colour temperature 2700K, 3000K, 3500K or 4000K. Binning initial  $\leq$  MacAdam 3. Colour rendering CRI>80 or CRI>90. Round base plate made of steel, colour matching luminaire body.

**FR** Lampadaire LED. Éclairage direct/indirect. Tête du luminaire en profilé aluminium avec une épaisseur fine de 38mm et diamètre 600mm. Surface laquée blanc, argent, graphite, noir, titane ou cuivre. Autres options de finition voir Lightnet-Surface-Collection ou RAL au choix. Diffuseur microprismatique adapté aux bureaux. Composants indirects avec une technologie de lentille innovante pour un éclairage grand angle du plafond. Deux boutons-poussoir sur le mât du luminaire pour graduation séparée et allumage indépendant de la partie Directe/Indirecte. Température de couleur 2700K, 3000K, 3500K ou 4000K. Binning initial  $\leq$  MacAdam 3. Rendu de couleur CRI>80 ou CRI>90. Pied du luminaire rond en acier, couleur adaptée au corps du luminaire.

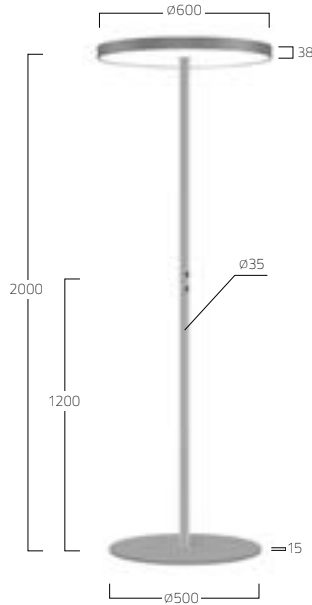

**PRODUCT-CODE:** **B F 4 A S X - 8 30 M - D600 - O**

PRODUCT FAMILY	- B: Basic
TYPE	- F4: Floor Direct-Indirect
OPTICAL SYSTEM	- A: Microprismatic
SURFACE FINISH	- W: Snow White, V: Ivory White, S: Radiant Silver, U: Urban Graphite, B: Jet Black, H: Champagne Silver, K: Satin Copper
CONTROL GEAR	- X: Separately Dimmable
COLOUR REND.	- 8: CRI>80, 9: CRI>90
COLOUR TEMP.	- 27: 2700K, 30: 3000K, 35: 3500K, 40: 4000K, TW: Tunable White 2700-6500K
POWER	- M: Medium Power
SIZE	- Luminaire Diameter in mm: D600
BASE	- O: Round Base



MICROPRISMATIC | DIRECT-INDIRECT

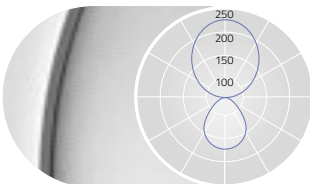

UGR $\leq$ 19 (X=4H, Y=8H, S=0.25H)  
DIRECT: ca.30% INDIRECT ca.70%

D mm	Lumen/Watt Medium Power
600	12730lm/88W

Lumen Values: Luminaire luminous flux at 4000K/CRI>80. Other configurations on request.



BASIC DÉCO  
FLOOR | F3



**DE** LED-Stehleuchte. Direkt-indirektstrahlend. Leuchtenkopf aus Aluminiumprofil mit Bauhöhe 58mm und Durchmesser 500mm. Gehäuse-Außenfläche und dekorativer Reflektorring in unterschiedlichen Lackierungen und Kombinationen erhältlich, z.B. weiß, silber, graphit, schwarz, gold oder kupferfarben. Zu Oberfläche-Optionen- und Kombinationen siehe Lightnet-Surface-Collection oder Bi-Colour-Auswahl. Rückversetzte Microprismenoptik mit optimierter Blendungsbegrenzung speziell für Office-Anwendungen. Indirektanteil mit innovativer Linsentechnologie für breitstrahlende Deckenaufhellung. Zwei Taster im Leuchtenmast für getrennt stufenlose Dimmung und Schaltung der Kamern für Direkt-/ Indirektlicht, alternativ gemeinsame Steuerung über modernste Sensor- oder Schwarmtechnologie. Farbtemperaturen 2700K, 3000K, 3500K oder 4000K. Binning initial  $\leq$  MacAdam 3. Farbwiedergabe CRI>80 oder CRI>90. Runde Fußplatte aus Stahl mit U-Cut-Out, Lackierung passend Leuchtenkörper.

**EN** LED free-standing luminaire. Direct-indirect light distribution. Luminaire head made of aluminium profile with overall height of 58mm and diameter of 500mm. Outer housing and decorative reflector ring available in various finishes and combinations, e.g. white, silver, graphite, black, gold or copper coated. For surface options and combinations check Lightnet Surface Collection or Bi-Colour Selection. Recessed Microprismatic with optimized glare reduction especially for workplaces. Indirect light with innovative lens technology for wide-angle ceiling illumination. 2 pushbuttons in the luminaire pole for dimming and switching the direct/ indirect light separately, alternatively common control via state-of-the-art sensor or swarm technology. Colour temperature 2700K, 3000K, 3500K or 4000K. Binning initial  $\leq$  MacAdam 3. Colour rendering CRI>80 or CRI>90. Round base plate made of steel with U-Cut-Out, colour matching luminaire body.

**FR** Lampadaire LED. Éclairage direct/indirect. Tête de luminaire en profilé aluminium avec une hauteur de 58mm et diamètre de 500mm. Surface du luminaire et réflecteur/bague décorative disponible en différentes combinaisons et couleurs au choix, Ex: blanc, argent, graphite, noir ou cuivre. Pour les options et combinaisons de finitions, voir Lightnet Surface Collection ou Bi-Colour Selection. Diffuseur microprismatique encastré avec réduction optimisée de l'éblouissement, spécialement pour les postes de travail. Composants indirects avec une technologie de lentille innovante pour un éclairage grand angle du plafond. Deux boutons-poussoir sur le mât du luminaire pour graduation séparée et allumage indépendant de la partie Directe/Indirecte, alternative de gestion groupée par la technologie moderne de sensor/cellule ou swarm control. Température de couleur 2700K, 3000K, 3500K ou 4000K. Binning initial  $\leq$  MacAdam 3. Rendu de couleur CRI>80 ou CRI>90. Base ronde fait d'acier en U-Cut-Out, couleur assortie au corps du luminaire.

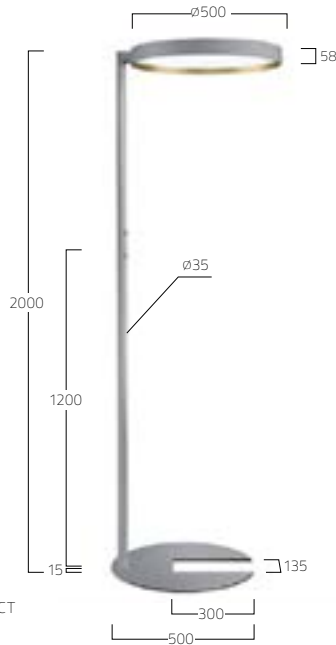

MICROPRISMATIC | DIRECT-INDIRECT

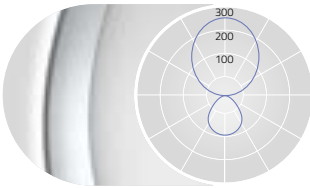

UGR $\leq$ 19 (X=4H, Y=8H, S=0.25H)  
DIRECT: ca.30% INDIRECT ca.70%

D mm	Lumen/Watt Medium Power
500	11710lm/81W

Lumen Values: Luminaire luminous flux at 4000K/CRI>80. Other configurations on request.

**PRODUCT-CODE:**

**B F3 A S X - 8 30 M - D500 - U G**

PRODUCT FAMILY	- B: Basic
TYPE	- F3: Floor Direct-Indirect
OPTICAL SYSTEM	- A: Microprismatic
SURFACE FINISH	- W: Snow White, V: Ivory White, S: Radiant Silver, U: Urban Graphite, B: Jet Black, H: Champagne Silver, K: Satin Copper
CONTROL GEAR	- X: Separately Dimmable, M: Multisensor Control, R: Swarm Control
COLOUR REND.	- 8: CRI>80, 9: CRI>90
COLOUR TEMP.	- 27: 2700K, 30: 3000K, 35: 3500K, 40: 4000K, TW: Tunable White 2700-6500K
POWER	- M: Medium Power
SIZE	- Luminaire Diameter in mm: D500
BASE	- U: U-Cut-Out
REFLECTOR	- W: Snow White, V: Ivory White, S: Radiant Silver, U: Urban Graphite B: Jet Black, H: Champagne Silver, K: Satin Copper, G: Satin Gold



MULTISENSOR CONTROL



BASIC DÉCO  
FLOOR | F5

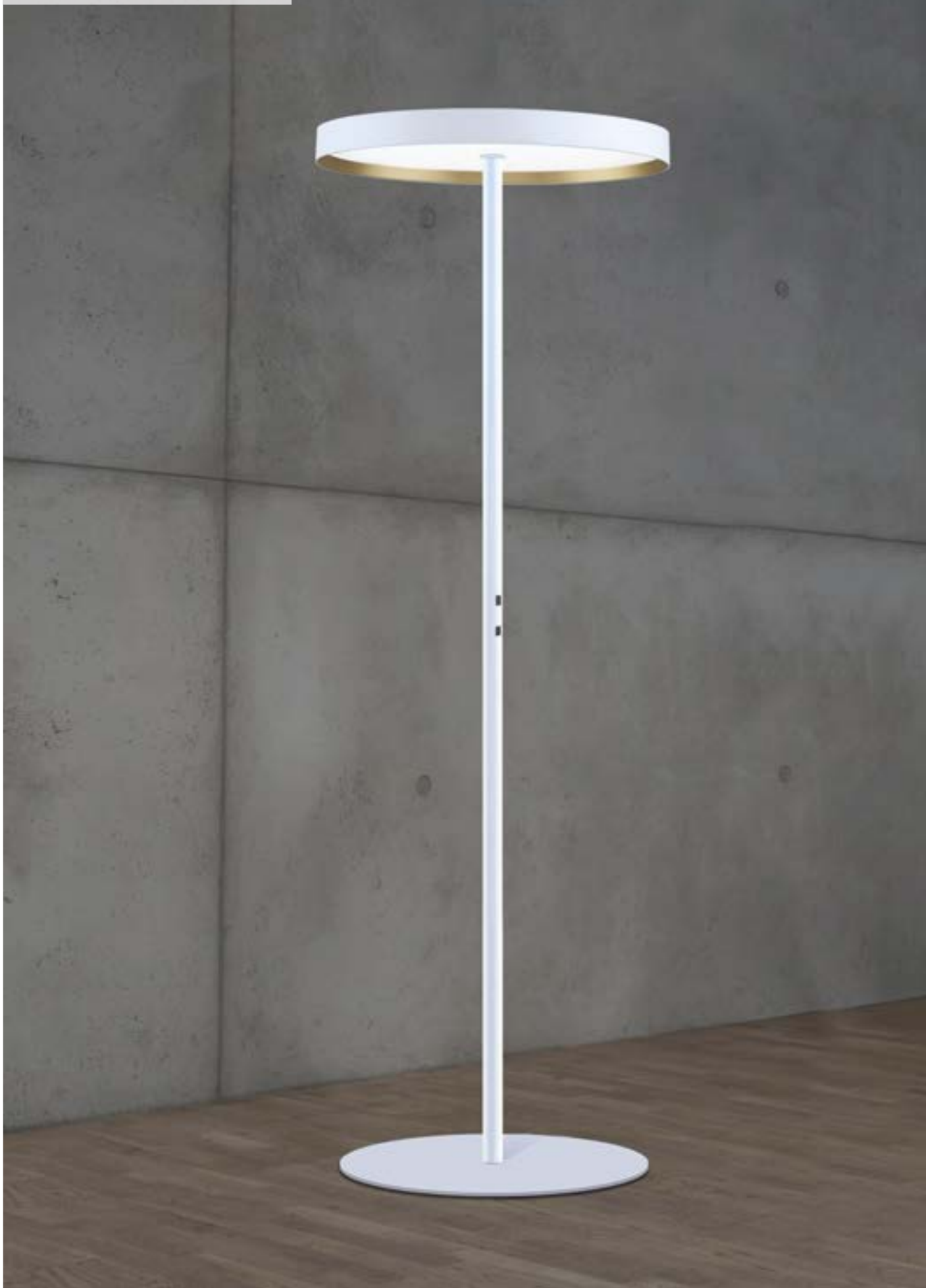

**DE** LED-Stehleuchte. Direkt-indirektstrahlend. Leuchtenkopf aus Aluminiumprofil mit Bauhöhe 58mm und Durchmesser 600mm. Gehäuse-Außenfläche und dekorativer Reflektorring in unterschiedlichen Lackierungen und Kombinationen erhältlich, z.B. weiß, silber, graphit, schwarz, gold oder kupferfarben. Zu Oberflächenoptionen- und Kombinationen siehe Lightnet-Surface-Collection oder Bi-Colour-Auswahl. Rückversetzte Microprismenoptik mit optimierter Blendungsbegrenzung speziell für Office-Anwendungen. Satinierter Opaldiffusor für Allgemeinbeleuchtung mit max. Transmissionsgrad und homogener Lichtpunkt-auflösung. Indirektanteil mit innovativer Linsentechnologie für breitstrahlende Deckenaufhellung. Zwei Taster im Leuchtenmast für getrennt stufenlose Dimmung und Schaltung der Kammern für Direkt-/ Indirektlicht, alternativ gemeinsame Steuerung über modernste Sensor- oder Schwarmtechnologie. Farbtemperaturen 2700K, 3000K, 3500K oder 4000K. Binning initial  $\leq$  MacAdam 3. Farbwiedergabe CRI>80 oder CRI>90. Runde Fußplatte aus Stahl, Lackierung passend Leuchtenkörper.

**EN** LED free-standing luminaire. Direct-indirect light distribution. Luminaire head made of aluminium profile with overall height of 58mm and diameter of 600mm. Outer housing and decorative reflector ring available in various finishes and combinations, e.g. white, silver, graphite, black, gold or copper coated. For surface options and combinations check Lightnet Surface Collection or Bi-Colour Selection. Recessed Microprismatic with optimized glare reduction especially for workplaces. Satin opal diffuser for general lighting with maximum transmittance and homogeneous lighting. Indirect light with innovative lens technology for wide-angle ceiling illumination. 2 pushbuttons in the luminaire pole for dimming and switching the direct /indirect light separately, alternatively common control via state-of-the-art sensor or swarm technology. Colour temperature 2700K, 3000K, 3500K or 4000K. Binning initial  $\leq$  MacAdam 3. Colour rendering CRI>80 or CRI>90. Round base plate made of steel, colour matching luminaire body.

**FR** Lampadaire LED. Éclairage direct/indirect. Tête du luminaire en profilé aluminium avec une hauteur de 58mm et diamètre de 600mm. Surface du luminaire et réflecteur/bague décorative disponible en différentes combinaisons et couleurs au choix, Ex: blanc, argent, graphite, noir ou cuivre. Pour les options et combinaisons de finitions, voir Lightnet Surface Collection ou Bi-Colour Selection. Diffuseur microprismatique encastré avec réduction optimisée de l'éblouissement, spécialement pour les postes de travail. Diffuseur opale satiné pour un éclairage général et une transmission maximale et homogène. Composants indirects avec une technologie de lentille innovante pour un éclairage grand angle du plafond. Deux boutons-poussoir sur le mât du luminaire pour graduation séparée et allumage indépendant de la partie Directe/Indirecte, alternative de gestion groupée par la technologie moderne de sensor/cellule ou swarm control. Température de couleur 2700K, 3000K, 3500K ou 4000K. Binning initial  $\leq$  MacAdam 3. Rendu de couleur CRI>80 ou CRI>90. Pied du luminaire rond en acier, couleur adaptée au corps du luminaire.

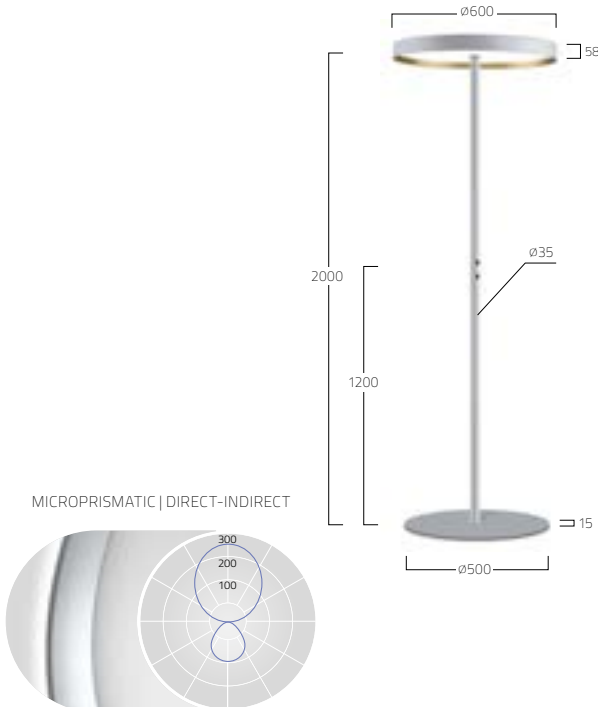

UGR $\leq$ 19 (X=4H, Y=8H, S=0.25H)  
DIRECT: ca.30% INDIRECT ca.70%

D mm	Lumen/Watt Medium Power
600	12730lm/88W

Lumen Values: Luminaire luminous flux at 4000K/CRI>80. Other configurations on request.

**PRODUCT-CODE:** B F5 A S X - 8 30 M - D600 - O G

PRODUCT FAMILY	- B Basic
TYPE	- F5 Floor Direct-Indirect
OPTICAL SYSTEM	- A Microprismatic
SURFACE FINISH	- W Snow White, V Ivory White, S Radiant Silver, U Urban Graphite, B Jet Black, H Champagne Silver, K Satin Copper
CONTROL GEAR	- X Separately Dimmable
COLOUR REND.	- 8 CRI>80, 9 CRI>90
COLOUR TEMP.	- 27 2700K, 30 3000K, 35 3500K, 40 4000K, TW Tunable White 2700-6500K
POWER	- M Medium Power
SIZE	- Luminaire Diameter in mm: D600
BASE	- O Round Base
REFLECTOR	- W Snow White, V Ivory White, S Radiant Silver, U Urban Graphite, B Jet Black, H Champagne Silver, K Satin Copper, G Satin Gold



BEAM ME UP JR.  
FLOOR | F3



**DE** LED-Stehleuchte mit rückversetzter Optik und dekorativem Reflektorring. Direkt-indirektstrahlend. Leuchtenkopf aus hochwertig verarbeitetem, glasfaserverstärktem Kunststoff (Fiberglas). Hochwertiger Pantograf mit Präzisionsgelenken komplett aus Aluminium. Keine sichtbaren Kabel, Federn oder Seile. Gehäuse-Außenfläche und dekorativer Reflektorring in unterschiedlichen Lackierungen und Kombinationen erhältlich, z.B. weiß, silber, graphit, schwarz, gold oder kupferfarben lackiert. Zu Oberflächenoptionen- und Kombinationen siehe Lightnet-Surface-Collection oder Bi-Colour-Auswahl. Microprismenoptik mit optimierter Blendungsbegrenzung speziell für Office-Anwendungen. Satinierter Opaldiffusor für Allgemeinbeleuchtung mit max. Transmissionsgrad und homogener Lichtpunktauflösung. Indirektanteil mit innovativer Linsentechnologie für breitstrahlende Deckenaufhellung. Zwei Taster im Leuchtenmast für getrennt stufenlose Dimmung und Schaltung der Kammern für Direkt-/ Indirektlicht. Farbtemperaturen 2200K, 2700K, 3000K, 3500K, 4000K oder 6500K. Binning initial  $\leq$  MacAdam 3. Farbwiedergabe CRI>80 oder CRI>90.

**EN** LED free-standing luminaire with a setback lens optic in a decorative ring. Direct-indirect light distribution. Luminaire head made of high-quality processed FRP (fiberglass reinforced plastic). High-quality pantograph with precision joints completely made of aluminium. No visible cables, springs or cords. Outer housing and decorative reflector ring available in various finishes and combinations, e.g. white, silver, graphite, black, gold or copper coated. For surface options and combinations check Lightnet Surface Collection or Bi-Colour Selection. Microprismatic with optimized glare reduction especially for workplaces. Satin opal diffuser for general lighting with maximum transmittance and homogeneous lighting. Indirect light with innovative lens technology for wide-angle ceiling illumination. Two pushbuttons in the luminaire pole for dimming and switching the direct/indirect light separately. Colour temperatures 2200K, 2700K, 3000K, 3500K, 4000K or 6500K. Binning initial  $\leq$  MacAdam 3. Colour rendering CRI>80 or CRI>90.

**FR** Luminaire LED sur pied avec optique/diffuseur en retrait et réflecteur/bague décorative. Éclairage direct/indirect. Tête du luminaire en matière travaillée hautement qualitative de fibre de verre. Pantographe de haute qualité avec articulation de précision complètement en aluminium. Pas de câbles, ressorts ou fils visibles. Surface du luminaire et réflecteur/bague décorative disponible en différentes combinaisons et couleurs au choix, Ex: blanc, argent, graphite, noir, or ou cuivre. Pour les options et combinaisons de finitions, voir Lightnet Surface Collection ou Bi-Colour Selection. Diffuseur microprismatique optimisé pour un éblouissement limité et adapté aux bureaux. Diffuseur opale satiné pour un éclairage général et une transmission maximale et homogène. Composants indirects avec une technologie de lentille innovante pour un éclairage grand angle du plafond. Deux boutons-poussoir sur le mât du luminaire pour graduation séparée et allumage indépendant de la partie Directe/Indirecte. Température de couleur 2200K, 2700K, 3000K, 3500K, 4000K ou 6500K. Binning initial  $\leq$  MacAdam 3. Rendu de couleur CRI>80 ou CRI>90.



**PRODUCT-CODE:** M F 3 A B X - 8 30 H - D700 - P G

PRODUCT FAMILY	- M: Beam Me Up
TYPE	- F3: Floor Direct-Indirect
OPTICAL SYSTEM	- A: Microprismatic, O: Opal
SURFACE FINISH	- W: Snow White, V: Ivory White, A: Satin Silver, U: Urban Graphite, B: Jet Black, H: Champagne Silver, K: Satin Copper
CONTROL GEAR	- X: Separately Dimmable
COLOUR REND.	- 8: CRI>80, 9: CRI>90
COLOUR TEMP.	- 22: 2200K, 27: 2700K, 30: 3000K, 35: 3500K, 40: 4000K, 65: 6500K, TW: Tunable White 2700-6500K
POWER	- H: High Power
SIZE	- Head Diameter in mm: D700
BASE TYPE	- P: Rectangular
REFLECTOR	- W: Snow White, V: Ivory White, A: Satin Silver, U: Urban Graphite, B: Jet Black, H: Champagne Silver, K: Satin Copper, G: Satin Gold

MICROPRISMATIC | DIRECT-INDIRECT

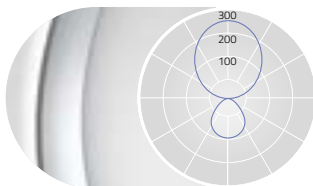

UGR $\leq$ 19 (X=4H, Y=8H, S=0.25H)  
DIRECT: ca.30% INDIRECT ca.70%

D mm	Lumen/Watt High Power
700	11000lm/81W

OPAL DIFFUSER | DIRECT-INDIRECT



DIRECT: ca.30% INDIRECT ca.70%

D mm	Lumen/Watt High Power
700	11200lm/81W



Lumen Values: Luminaire luminous flux at 4000K/CRI>80. Other configurations on request.





BEAM ME UP JR.  
FLOOR | F4



**DE** LED-Stehleuchte mit rückversetzter Optik und dekorativem Reflektorring. Direkt-indirektstrahlend. Leuchtenkopf aus hochwertig verarbeitetem, glasfaserverstärktem Kunststoff (Fiberglas). Gehäuse- und Außenfläche und dekorativer Reflektorring in unterschiedlichen Lackierungen und Kombinationen erhältlich, z.B. weiß, silber, graphit, schwarz, gold oder kupferfarben lackiert. Zu Oberflächenoptionen- und Kombinationen siehe Lightnet-Surface-Collection oder Bi-Colour-Auswahl. Microprismenoptik mit optimierter Blendungsbegrenzung speziell für Office-Anwendungen. Satinierter Opaldiffusor für Allgemeinbeleuchtung mit max. Transmissionsgrad und homogener Lichtpunkt auflösung. Indirektanteil mit innovativer Linsentechnologie für breitstrahlende Deckenaufhellung. Zwei Taster im Leuchtenmast für getrennt stufenlose Dimmung und Schaltung der Kammern für Direkt-/ Indirektlicht. Farbtemperaturen 2200K, 2700K, 3000K, 3500K, 4000K oder 6500K. Binning initial ≤ MacAdam 3. Farbwiedergabe CRI>80 oder CRI>90. Runde Fußplatte aus Stahl, Lackierung passend Leuchtenkörper.

**EN** LED free-standing luminaire with a setback lens optic in a decorative ring. Direct-indirect light distribution. Luminaire head made of high-quality processed FRP (fiberglass reinforced plastic). Outer housing and decorative reflector ring available in various finishes and combinations, e.g. white, silver, graphite, black, gold or copper coated. For surface options and combinations check Lightnet Surface Collection or Bi-Colour Selection. Microprismatic with optimized glare reduction especially for workplaces. Satin opal diffuser for general lighting with maximum transmittance and homogeneous lighting. Indirect light with innovative lens technology for wide-angle ceiling illumination. Two pushbuttons in the luminaire pole for dimming and switching the direct/indirect light separately. Colour temperatures 2200K, 2700K, 3000K, 3500K, 4000K or 6500K. Binning initial ≤ MacAdam 3. Colour rendering CRI>80 or CRI>90. Round base plate made of steel, colour matching luminaire body.

**FR** Luminaire LED sur pied avec optique/diffuseur en retrait et réflecteur/bague décorative. Éclairage direct /indirect. Tête du luminaire en matière travaillée hautement qualitative de fibre de verre. Surface du luminaire et réflecteur/bague décorative disponible en différentes combinaisons et couleurs au choix, Ex: blanc, argent, graphite, noir, or ou cuivre. Pour les options et combinaisons de finitions, voir Lightnet Surface Collection ou Bi-Colour Selection. Diffuseur microprismatique optimisé pour un éblouissement limité et adapté aux bureaux. Diffuseur opale satiné pour un éclairage général et une transmission maximale et homogène. Composants indirects avec une technologie de lentille innovante pour un éclairage grand angle du plafond. Deux boutons-poussoir sur le mât du luminaire pour gradation séparée et allumage indépendant de la partie Directe/Indirecte. Température de couleur 2200K, 2700K, 3000K, 3500K, 4000K ou 6500K. Binning initial ≤ MacAdam 3. Rendu de couleur CRI>80 ou CRI>90. Pied du luminaire rond en acier, couleur adaptée au corps du luminaire.

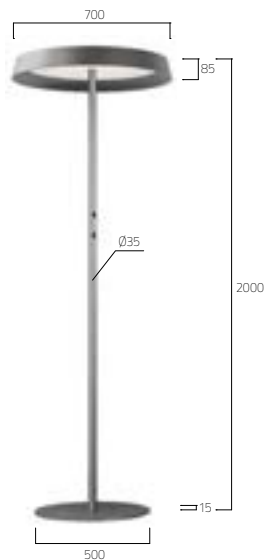

**PRODUCT-CODE:** M F4 A B X - 8 30 H - D700 - O G

PRODUCT FAMILY	M: Beam Me Up
TYPE	F4: Floor Direct-Indirect
OPTICAL SYSTEM	A: Microprismatic, O: Opal
SURFACE FINISH	W: Snow White, V: Ivory White, A: Satin Silver, U: Urban Graphite, B: Jet Black, H: Champagne Silver, K: Satin Copper
CONTROL GEAR	X: Separately Dimmable
COLOUR REND.	8: CRI>80, 9: CRI>90
COLOUR TEMP.	22: 2200K, 27: 2700K, 30: 3000K, 35: 3500K, 40: 4000K, 65: 6500K, TW: Tunable White 2700-6500K
POWER	H: High Power
SIZE	Head Diameter in mm: D700
BASE TYPE	O: Round
REFLECTOR	W: Snow White, V: Ivory White, A: Satin Silver, U: Urban Graphite, B: Jet Black, H: Champagne Silver, K: Satin Copper, G: Satin Gold



MICROPRISMATIC | DIRECT-INDIRECT

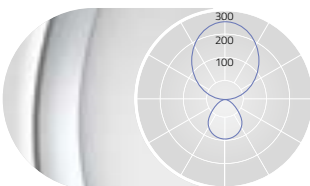

UGR≤19 (X=4H, Y=8H, S=0.25H)  
DIRECT: ca.30% INDIRECT ca.70%

D mm	Lumen/Watt High Power
700	12000lm/86W

OPAL DIFFUSER | DIRECT-INDIRECT



DIRECT: ca.30% INDIRECT ca.70%

D mm	Lumen/Watt High Power
700	12300lm/86W



# CUBIC EVOLUTION FLOOR



DM UNTERNEHMENSZENTRALE, KARLSRUHE, GERMANY  
CUBIC-F6



# CUBIC EVOLUTION FLOOR



DM UNTERNEHMENSZENTRALE, KARLSRUHE, GERMANY  
CUBIC-F2



# CUBIC EVOLUTION FLOOR | F2



**DE** LED-Stehleuchte. Direkt-indirektstrahlend. Leuchtenkörper in minimalistischer Bauhöhe aus Aluminiumprofil. Oberfläche natureloxiert oder weiß, graphit, schwarz bzw. champagnerfarben lackiert sowie Alu poliert. Weitere Oberflächenoptionen siehe Lightnet-Surface-Collection oder RAL nach Wahl. Microprismenoptik mit optimierter Blendungsbegrenzung speziell für Office-Anwendungen bei vollständiger Lichtpunkttafllösung. Intuitives Bedienfeld im Leuchtenmast für getrennt stufenlose Dimmung und Schaltung der Kammern für Direkt-/Indirektlicht, alternativ gemeinsame Steuerung über modernste Sensor- oder Schwarmtechnologie. Farbtemperatur 3000K, 3500K oder 4000K. Binning initial  $\leq$  MacAdam 3. Farbwiedergabe CRI>80 oder CRI>90. Rechteckige Fußplatte aus Stahl mit U- oder Side-Cut-Out für unterschiedliche Tischausführungen, Lackierung passend Leuchtenkörper.

**EN** LED free-standing luminaire. Direct-indirect light distribution. Luminaire body with minimalistic overall height made of aluminium profile. Surface natural anodised or white, graphite, black or champagne coated as well as polished aluminium. Further surface options see Lightnet-Surface-Collection or RAL of your choice. Microprismatic with optimized glare reduction especially for workplaces with uniform and enhanced light transmission. Intuitive control panel in luminaire pole for dimming and switching the direct/indirect light separately, alternatively together controlable via state-of-the-art sensor or swarm technology. Colour temperature 3000K, 3500K or 4000K. Binning initial  $\leq$  MacAdam 3. Colour rendering CRI>80 or CRI>90. Rectangular base plate made of steel with U- or Side Cut-Out for different table designs, colour matching luminaire body.

**FR** Lampadaire LED. Éclairage direct/indirect. Corps du luminaire en profilé aluminium et épaisseur minimaliste. Surface anodisée ou laquée blanc, graphite, noir, champagne ou polie. Autres options de finition voir Lightnet-Surface-Collection ou RAL au choix. Diffuseur microprismatique avec réduction optimisée de l'éblouissement, spécialement pour les postes de travail avec une transmission lumineuse uniforme et améliorée. Commande intuitive sur le mât du luminaire pour une graduation séparée l'allumage Direct et Indirect, alternative de gestion groupée au travers de la technologie moderne de sensor/cellule ou swarm control. Température de couleur 3000K, 3500K ou 4000K. Binning initial  $\leq$  MacAdam 3. Rendu de couleur CRI>80 ou CRI>90. Pied du luminaire en forme de U rectangulaire ou découpe latérale Side-Cut-Out pour différents modèles de bureaux et applications, couleur au choix adaptée au corps du luminaire.

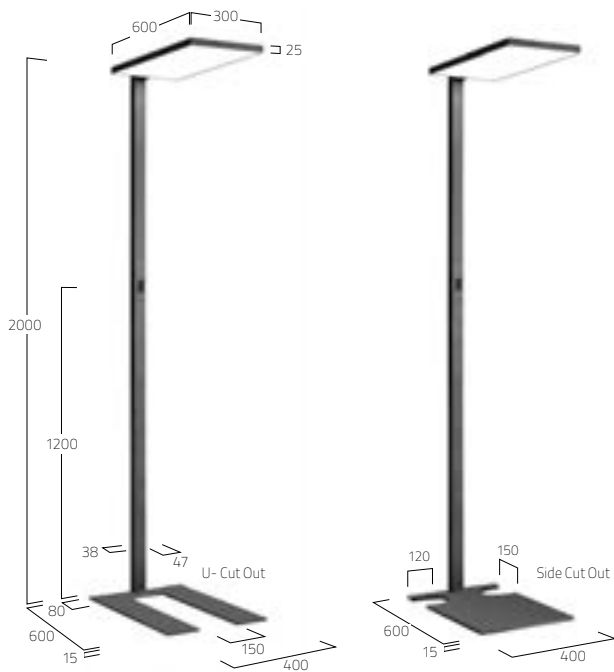

PRODUCT-CODE:	C F 2 A B X - 8 30 M - L600 - U
PRODUCT FAMILY	- C. Cubic
TYPE	- F2. Floor Direct-Indirect
OPTICAL SYSTEM	- A. Microprismatic
SURFACE FINISH	- W. Snow White, E. Silver Anodised, U. Urban Graphite, B. Jet Black, H. Champagne Silver, P. Polished Aluminium
CONTROL GEAR	- X. Separately Dimmable, R. Swarm Control, M. Multisensor Control
COLOUR REND.	- 8. CRI>80, 9. CRI>90, F. Full Spectrum
COLOUR TEMP.	- 30. 3000K, 35. 3500K, 40. 4000K, TW. Tunable White 2700-6500K
POWER	- M. Medium Power, H. High Power
SIZE	- L600. Head Length in mm
BASE	- S. Side Cut-Out, U. U-Cut-Out, P. Rectangular



MICROPRISMATIC | DIRECT-INDIRECT



UGR $\leq$ 19 (X=4H, Y=8H, S=0.25H)  
DIRECT: ca.15% INDIRECT ca.85%

L mm	Lumen/Watt Medium Power	Lumen/Watt High Power
600	11090lm/68W	15090lm/96W

Lumen Values: Luminaire luminous flux at 4000K/CRI>80. Other configurations on request.





# CUBIC EVOLUTION FLOOR | F3



**DE** LED-Stehleuchte. Direkt-indirektstrahlend. Leuchtenkörper in minimalistischer Bauhöhe aus Aluminiumprofil. Oberfläche natureloxiert oder weiß, graphit, schwarz bzw. champagnerfarben lackiert sowie Alu poliert. Weitere Oberflächenoptionen siehe Lightnet-Surface-Collection oder RAL nach Wahl. Microprismenoptik mit optimierter Blendungsbegrenzung speziell für Office-Anwendungen bei vollständiger Lichtpunktauflösung. Intuitives Bedienfeld im Leuchtenmast für getrennt stufenlose Dimmung und Schaltung der Kammern für Direkt-/Indirektlicht, alternativ gemeinsame Steuerung über modernste Sensor- oder Schwarmtechnologie. Farbtemperatur 3000K, 3500K oder 4000K. Binning initial  $\leq$  MacAdam 3. Farbwiedergabe CRI>80 oder CRI>90. Rechteckige Fußplatte aus Stahl mit U- oder Side-Cut-Out für unterschiedliche Tischausführungen, Lackierung passend Leuchtenkörper.

**EN** LED free-standing luminaire. Direct-indirect light distribution. Luminaire body with minimalistic overall height made of aluminium profile. Surface natural anodised or white, graphite, black or champagne coated as well as polished aluminium. Further surface options see Lightnet-Surface-Collection or RAL of your choice. Microprismatic with optimized glare reduction especially for workplaces with uniform and enhanced light transmission. Intuitive control panel in luminaire pole for dimming and switching the direct/indirect light separately, alternatively together controllable via state-of-the-art sensor or swarm technology. Colour temperature 3000K, 3500K or 4000K. Binning initial  $\leq$  MacAdam 3. Colour rendering CRI>80 or CRI>90. Rectangular base plate made of steel with U- or Side Cut-Out for different table designs, colour matching luminaire body.

**FR** Lampadaire LED. Éclairage direct/indirect. Corps du luminaire en profilé aluminium et épaisseur minimale. Surface anodisée ou laquée blanc, graphite, noir, champagne ou polie. Autres options de finition voir Lightnet-Surface-Collection ou RAL au choix. Diffuseur microprismatique avec réduction optimisée de l'éblouissement, spécialement pour les postes de travail avec une transmission lumineuse uniforme et améliorée. Commande intuitive sur le mât du luminaire pour une graduation séparée l'allumage Direct et Indirect, alternative de gestion groupée au travers de la technologie moderne de sensor/cellule ou swarm control. Température de couleur 3000K, 3500K ou 4000K. Binning initial  $\leq$  MacAdam 3. Rendu de couleur CRI>80 ou CRI>90. Pied du luminaire en forme de U rectangulaire ou découpe latérale Side-Cut-Out pour différents modèles de bureaux et applications, couleur au choix adaptée au corps du luminaire.



**PRODUCT-CODE:** C F 3 A B X - 8 30 M - L600 - U

- PRODUCT FAMILY - C. Cubic
- TYPE - F3. Floor Direct-Indirect
- OPTICAL SYSTEM - A. Microprismatic
- SURFACE FINISH - W. Snow White, E. Silver Anodised, U. Urban Graphite, B. Jet Black, H. Champagne Silver, P. Polished Aluminium
- CONTROL GEAR - X. Separately Dimmable, M. Multisensor Control, R. Swarm Control
- COLOUR REND. - 8. CRI>80, 9. CRI>90, F. Full Spectrum
- COLOUR TEMP. - 30. 3000K, 35. 3500K, 40. 4000K, TW. Tunable White 2700-6500K
- POWER - M. Medium Power, H. High Power
- SIZE - L600. Head Length in mm
- BASE - S. Side Cut-Out, U. U-Cut-Out, P. Rectangular



MICROPRISMATIC | DIRECT-INDIRECT

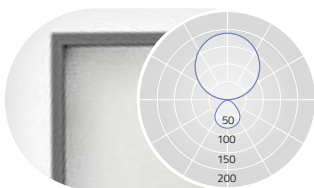

UGR $\leq 19$  (X=4H, Y=8H, S=0.25H)  
DIRECT: ca.15% INDIRECT ca.85%

L mm	Lumen/Watt Medium Power	Lumen/Watt High Power
600	11090lm/68W	15090lm/96W

Lumen Values: Luminaire luminous flux at 4000K/CRI>80. Other configurations on request.



# CUBIC EVOLUTION FLOOR | F4



**DE** LED-Stehleuchte. Direkt-indirektstrahlend. Leuchtenkörper in minimalistischer Bauhöhe aus Aluminiumprofil. Oberfläche naturel oxidiert oder weiß, graphit, schwarz bzw. champagnerfarben lackiert sowie Alu poliert. Weitere Oberflächenoptionen siehe Lightnet-Surface-Collection oder RAL nach Wahl. Microprismenoptik mit optimierter Blendungsbegrenzung speziell für Office-Anwendungen. Leuchtenkopf wahlweise in zwei unterschiedlichen Ausrichtungen (left/right) mit vollständiger Auflösung der Lichtpunkte. Intuitives Bedienfeld im Leuchten-mast für stufenlose Dimmung oder Schaltung, alternativ weitgehend autarke Steuerung über modernste Sensortechnologie. Farbtemperatur 3000K, 3500K oder 4000K. Binning initial  $\leq$  MacAdam 3. Farbwiedergabe CRI>80 oder CRI>90. Rechteckige Fußplatte aus Stahl, Lackierung passend Leuchtenkörper.

**EN** LED free-standing luminaire. Direct-indirect light distribution. Luminaire body with minimalistic overall height made of aluminium profile. Surface natural anodised or white, graphite, black or champagne coated as well as polished aluminium. Further surface options see Lightnet-Surface-Collection or RAL of your choice. Microprismatic with optimized glare reduction especially for workplaces. Luminaire head available in two different directions (left/right) with perfect uniform and enhanced light transmission. Intuitive control panel in luminaire pole for dimming or switching, alternatively mostly self-sufficient control via state-of-the-art sensor technology. Colour temperature 3000K, 3500K or 4000K. Binning initial  $\leq$  MacAdam 3. Colour rendering CRI>80 or CRI>90. Rectangular base plate made of steel, colour matching luminaire body.

**FR** Lampadaire LED. Éclairage direct/indirect. Corps du luminaire en profilé aluminium et épaisseur minimaliste. Surface anodisée ou laquée blanc, graphite, noir, champagne ou polie. Autres options de finition voir Lightnet-Surface-Collection ou RAL au choix. Diffuseur microprismatique optimisé pour un éblouissement limité et adapté aux bureaux. Tête du luminaire disponible dans deux directions différentes (gauche/droite) avec une transmission lumineuse parfaitement uniforme. Panneau de commande intuitif sur le pôle du luminaire pour graduer ou ON/OFF, ou alors en grande partie autonome grâce à une technologie de capteurs ultramoderne. Température de couleur 3000K, 3500K ou 4000K. Binning initial  $\leq$  MacAdam 3. Rendu de couleur CRI>80 ou CRI>90. Pied du luminaire en acier, couleur au choix adaptée au corps du luminaire.

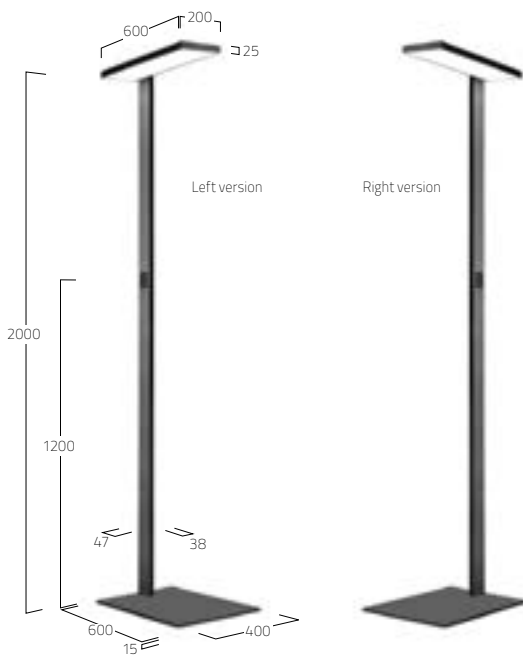

**PRODUCT-CODE:** C F4 A B S - 8 30 M - L600 - P L

PRODUCT FAMILY	- C: Cubic
TYPE	- F4: Floor Direct-Indirect
OPTICAL SYSTEM	- A: Microprismatic
SURFACE FINISH	- W: Snow White, E: Silver Anodised, U: Urban Graphite, B: Jet Black, H: Champagne Silver, P: Polished Aluminium
CONTROL GEAR	- S: Switch & Dim, X: Separately Dimmable, M: Multisensor Control, R: Swarm Control
COLOUR REND.	- 8: CRI>80, 9: CRI>90, F: Full Spectrum
COLOUR TEMP.	- 30: 3000K, 35: 3500K, 40: 4000K, TW: Tunable White 2700-6500K
POWER	- M: Medium Power, H: High Power
SIZE	- L600: Head Length in mm
BASE	- P: Rectangular Base
VERSION	- L: Left, R: Right



MICROPRISMATIC | DIRECT-INDIRECT

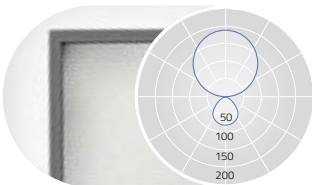

UGR $\leq$ 19 (X=4H, Y=8H, S=0.25H)  
DIRECT: ca.15% INDIRECT ca.85%

L mm	Lumen/Watt Medium Power	Lumen/Watt High Power
600	5750lm/44W	7740lm/57W

Lumen Values: Luminaire luminous flux at 4000K/CRI>80. Other configurations on request.

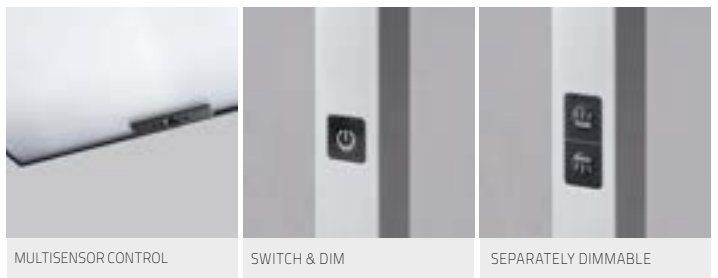

# CUBIC EVOLUTION FLOOR | F5



**DE** LED-Stehleuchte. Direkt-indirektstrahlend. Leuchtenkörper in minimalistischer Bauhöhe aus Aluminiumprofil. Oberfläche naturelroxiert oder weiß, graphit, schwarz bzw. champagnerfarben lackiert sowie Alu poliert. Weitere Oberflächenoptionen siehe Lightnet-Surface-Collection oder RAL nach Wahl. Microprismenoptik mit optimierter Blendungsbegrenzung speziell für Office-Anwendungen bei vollständiger Lichtpunktauflösung. Intuitive Bedienfelder im Leuchtenmast für eine getrennt stufenlose Dimmung und Schaltung der Leuchtenköpfe, alternativ Steuerung je Leuchtenkopf über modernste Sensortechnologie. Farbtemperatur 3000K, 3500K oder 4000K. Binning initial  $\leq$  MacAdam 3. Farbwiedergabe CRI>80 oder CRI>90. Rechteckige Fußplatte aus Stahl, Lackierung passend Leuchtenkörper.

**EN** LED free-standing luminaire. Direct-indirect light distribution. Luminaire body with minimalistic overall height made of aluminium profile. Surface natural anodised or white, graphite, black or champagne coated as well as polished aluminium. Further surface options see Lightnet-Surface-Collection or RAL of your choice. Microprismatic with optimized glare reduction especially for workplaces with uniform and enhanced light transmission. Intuitive control panels in the luminaire pole for dimming and switching the luminaire heads separately, alternatively control for each luminaire head via state-of-the-art sensor technology. Colour temperature 3000K, 3500K or 4000K. Binning initial  $\leq$  MacAdam 3. Colour rendering CRI>80 or CRI>90. Rectangular base plate made of steel, colour matching luminaire body.

**FR** Lampadaire LED. Éclairage direct/indirect. Corps du luminaire en profilé aluminium et épaisseur minimaliste. Surface anodisée ou laquée blanc, graphite, noir, champagne ou polie. Autres options de finition voir Lightnet-Surface-Collection ou RAL au choix. Dif-fuseur microprismatique avec réduction optimisée de l'éblouissement, spécialement pour les postes de travail avec une transmission lumineuse uniforme et améliorée. Commande intuitive sur le mât pour une graduation séparée et l'allumage de la tête du luminaire, alternative de gestion par appareil de la technologie moderne de sensor/cellule. Température de couleur 3000K, 3500K ou 4000K. Binning initial  $\leq$  MacAdam 3. Rendu de couleur CRI>80 ou CRI>90. Pied du luminaire en acier, couleur au choix adaptée au corps du luminaire.

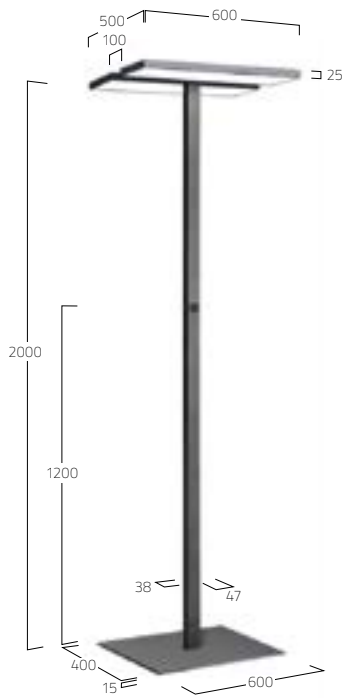

**PRODUCT-CODE:** C F 5 A B X - 8 30 M - L600 - P

PRODUCT FAMILY	- C: Cubic
TYPE	- F5: Floor Direct-Indirect
OPTICAL SYSTEM	- A: Microprismatic
SURFACE FINISH	- W: Snow White, E: Silver Anodised, U: Urban Graphite, B: Jet Black, H: Champagne Silver, P: Polished Aluminium
CONTROL GEAR	- S: Switch & Dim, X: Separately Dimmable, M: Multisensor Control, R: Swarm Control
COLOUR REND.	- 8: CRI>80, 9: CRI>90, F: Full Spectrum
COLOUR TEMP.	- 30: 3000K, 35: 3500K, 40: 4000K, TW: Tunable White 2700-6500K
POWER	- M: Medium Power, H: High Power
SIZE	- L600: Head Length in mm
BASE	- P: Rectangular Base



MICROPRISMATIC | DIRECT-INDIRECT

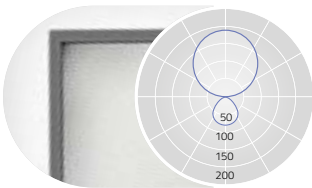

UGR $\leq$ 19 (X=4H, Y=8H, S=0.25H)  
DIRECT: ca.15% INDIRECT ca.85%

L mm	Lumen/Watt Medium Power	Lumen/Watt High Power
600	11500lm/88W	15480lm/114W

Lumen Values: Luminaire luminous flux at 4000K/CRI>80. Other configurations on request.

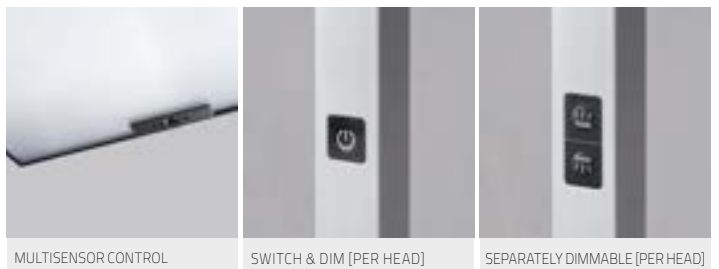

# CUBIC EVOLUTION FLOOR | F6



**DE** LED-Stehleuchte. Direkt-indirektstrahlend. Leuchtenkörper in minimalistischer Bauhöhe aus Aluminiumprofil. Oberfläche natureloxiert oder weiß, graphit, schwarz bzw. champagnerfarben lackiert sowie Alu poliert. Weitere Oberflächenoptionen siehe Lightnet-Surface-Collection oder RAL nach Wahl. Microprismenoptik mit optimierter Blendungsbegrenzung speziell für Office-Anwendungen bei vollständiger Lichtpunktauflösung. Intuitive Bedienfelder im Leuchtenmast für eine getrennt stufenlose Dimmung und Schaltung der Leuchtenköpfe, alternativ Steuerung je Leuchtenkopf über modernste Sensortechnologie. Farbtemperatur 3000K, 3500K oder 4000K. Binning initial  $\leq$  MacAdam 3. Farbwiedergabe CRI>80 oder CRI>90. Rechteckige Fußplatte aus Stahl mit U- oder Side-Cut-Out für unterschiedliche Tischausführungen, Lackierung passend Leuchtenkörper.

**EN** LED free-standing luminaire. Direct-indirect light distribution. Luminaire body with minimalistic overall height made of aluminium profile. Surface natural anodised or white, graphite, black or champagne coated as well as polished aluminium. Further surface options see Lightnet-Surface-Collection or RAL of your choice. Microprismatic with optimized glare reduction especially for workplaces with uniform and enhanced light transmission. Intuitive control panels in the luminaire pole for dimming and switching the luminaire heads separately, alternatively control for each luminaire head via state-of-the-art sensor technology. Colour temperature 3000K, 3500K or 4000K. Binning initial  $\leq$  MacAdam 3. Colour rendering CRI>80 or CRI>90. Rectangular base plate made of steel with U- or Side Cut-Out for different table designs, colour matching luminaire body.

**FR** Lampadaire LED. Éclairage direct/indirect. Corps du luminaire en profilé aluminium et épaisseur minimaliste. Surface anodisée ou laquée blanc, graphite, noir, champagne ou polie. Autres options de finition voir Lightnet-Surface-Collection ou RAL au choix. Diffuseur microprismatique avec réduction optimisée de l'éblouissement, spécialement pour les postes de travail avec une transmission lumineuse uniforme et améliorée. Commande intuitive sur le mât pour une gradation séparée et l'allumage de la tête du luminaire, alternative de gestion par appareil de la technologie moderne de sensor/cellule. Température de couleur 3000K, 3500K ou 4000K. Binning initial  $\leq$  MacAdam 3. Rendu de couleur CRI>80 ou CRI>90. Pied du luminaire en forme de U rectangulaire ou découpe latérale Side-Cut-Out pour différents modèles de bureaux et applications, couleur au choix adaptée au corps du luminaire.



**PRODUCT-CODE:** C F6 A B X - 8 30 M - L600 - U

- PRODUCT FAMILY – C: Cubic
- TYPE – F6: Floor Direct-Indirect
- OPTICAL SYSTEM – A: Microprismatic
- SURFACE FINISH – W: Snow White, E: Silver Anodised, U: Urban Graphite, B: Jet Black, H: Champagne Silver, P: Polished Aluminium
- CONTROL GEAR – S: Switch & Dim, X: Separately Dimmable, M: Multisensor Control, R: Swarm Control
- COLOUR REND. – 8: CRI>80, 9: CRI>90, F: Full Spectrum
- COLOUR TEMP. – 30: 3000K, 35: 3500K, 40: 4000K, TW: Tunable White 2700-6500K
- POWER – M: Medium Power, H: High Power
- SIZE – L600: Head Length in mm
- BASE – S: Side Cut-Out, U: U-Cut-Out, P: Rectangular



MICROPRISMATIC | DIRECT-INDIRECT

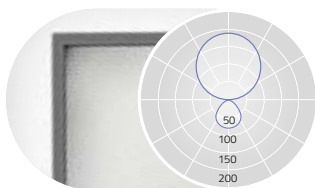

UGR $\leq$ 19 (X=4H, Y=8H, S=0.25H)  
DIRECT: ca.15% INDIRECT ca.85%

L mm	Lumen/Watt Medium Power	Lumen/Watt High Power
600	11500lm/88W	15480lm/114W

Lumen Values: Luminaire luminous flux at 4000K/CRI>80. Other configurations on request.





# CUBIC EVOLUTION FLOOR | F7

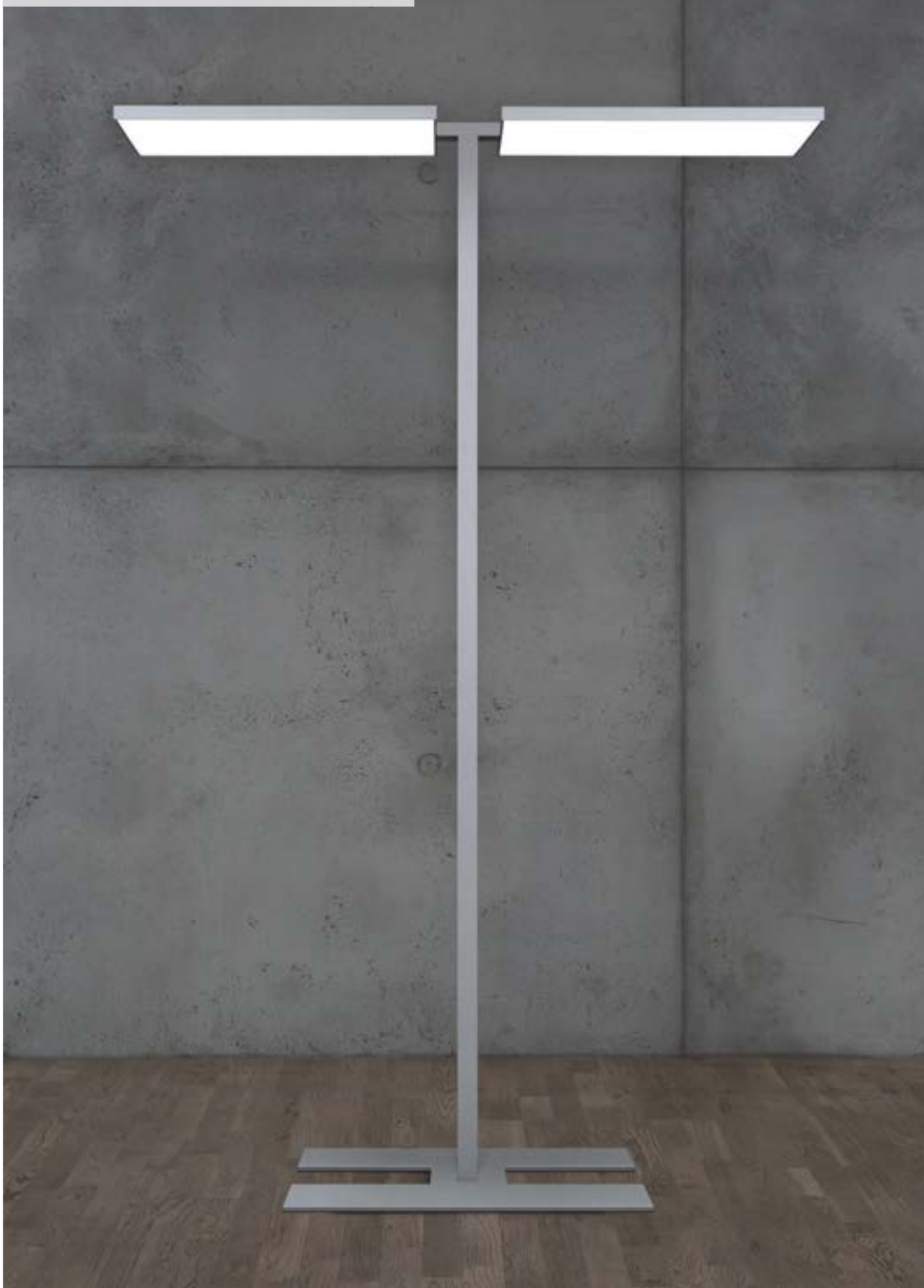

**DE** LED-Stehleuchte. Direkt-indirektstrahlend. Leuchtenkörper in minimalistischer Bauhöhe aus Aluminiumprofil. Oberfläche natureloxiert oder weiß, graphit, schwarz bzw. champagnerfarben lackiert sowie Alu poliert. Weitere Oberflächenoptionen siehe Lightnet-Surface-Collection oder RAL nach Wahl. Microprismenoptik mit optimierter Blendungsbegrenzung speziell für Office-Anwendungen bei vollständiger Lichtpunktauflösung. Intuitives Bedienfeld im Leuchtenmast für getrennt stufenlose Dimmung und Schaltung der Kammern für Direkt-/ Indirektlicht, alternativ gemeinsame Steuerung über modernste Sensor- oder Schwarmtechnologie. Rechteckige Fußplatte aus Stahl mit H-Cut-Out für unterschiedliche Tischausführungen, Lackierung passend Leuchtenkörper.

**EN** LED free-standing luminaire. Direct-indirect light distribution. Luminaire body with minimalistic overall height made of aluminium profile. Surface natural anodised or white, graphite, black or champagne coated as well as polished aluminium. Further surface options see Lightnet-Surface-Collection or RAL of your choice. Microprismatic with optimized glare reduction especially for workplaces with uniform and enhanced light transmission. Intuitive control panel in luminaire pole for dimming and switching the direct/indirect light separately, alternatively together controllable via state-of-the-art sensor or swarm technology. Rectangular base plate made of steel with H-Cut-Out for different table designs, colour matching luminaire body.

**FR** Lampadaire LED. Éclairage direct/indirect. Corps du luminaire en profilé aluminium et épaisseur minimaliste. Surface anodisée ou laquée blanc, graphite, noir, champagne ou polie. Autres options de finition voir Lightnet-Surface-Collection ou RAL au choix. Diffuseur microprismatique avec réduction optimisée de l'éblouissement, spécialement pour les postes de travail avec une transmission lumineuse uniforme et améliorée. Commande intuitive sur le mât du luminaire pour une graduation séparée l'allumage Direct et Indirect, alternative de gestion groupée au travers de la technologie moderne de sensor/cellule ou swarm control. Pied du luminaire en forme de H rectangulaire pour différents modèles de bureaux et applications, couleur au choix adaptée au corps du luminaire.

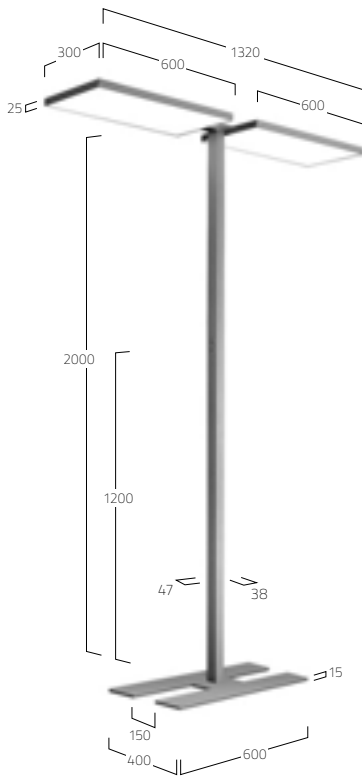

**PRODUCT-CODE: C F 7 A B S - 8 30 M - L1320 - H**

PRODUCT FAMILY	- C: Cubic
TYPE	- F7: Floor Direct-Indirect
OPTICAL SYSTEM	- A: Microprismatic
SURFACE FINISH	- W: Snow White, E: Silver Anodised, U: Urban Graphite, B: Jet Black, H: Champagne Silver, P: Polished Aluminium
CONTROL GEAR	- X: Separately Dimmable, M: Multisensor Control, R: Swarm Control
COLOUR REND.	- 8: CRI>80, 9: CRI>90, F: Full Spectrum
COLOUR TEMP.	- 30: 3000K, 35: 3500K, 40: 4000K, TW: Tunable White 2700-6500K
POWER	- M: Medium Power, H: High Power
SIZE	- L1320: Head Length in mm
BASE	- H: H-Cut-Out



MICROPRISMATIC | DIRECT-INDIRECT

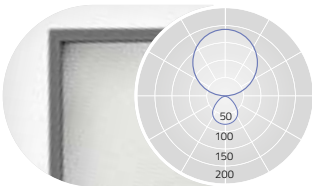

UGR<sub>s</sub>19 (X=4H, Y=8H, S=0.25H)  
DIRECT: ca.15% INDIRECT ca.85%

L mm	Lumen/Watt Medium Power	Lumen/Watt High Power
1320	22180lm/136W	30180lm/192W

Lumen Values: Luminaire luminous flux at 4000K/CRI>80. Other configurations on request.



# CUBIC EVOLUTION FLOOR | F8



**DE** LED-Stehleuchte. Direkt-indirektstrahlend. Leuchtenkörper in minimalistischer Bauhöhe aus Aluminiumprofil. Oberfläche natureloxiert oder weiß, graphit, schwarz bzw. champagnerfarben lackiert sowie Alu poliert. Weitere Oberflächenoptionen siehe Lightnet-Surface-Collection oder RAL nach Wahl. Microprismenoptik mit optimierter Blendungsbegrenzung speziell für Office-Anwendungen bei vollständiger Lichtpunktauflösung. Intuitives Bedienfeld im Leuchtenmast für getrennt stufenlose Dimmung und Schaltung der Kamern für Direkt-/Indirektlicht. Farbtemperatur 3000K, 3500K oder 4000K. Binning initial  $\leq$  MacAdam 3. Farbwiedergabe CRI>80 oder CRI>90. Rechteckige Fußplatte aus Stahl, Lackierung passend Leuchtenkörper.

**EN** LED free-standing luminaire. Direct-indirect light distribution. Luminaire body with minimalistic overall height made of aluminium profile. Surface natural anodised or white, graphite, black or champagne coated as well as polished aluminium. Further surface options see Lightnet-Surface-Collection or RAL of your choice. Microprismatic with optimized glare reduction especially for workplaces with uniform and enhanced light transmission. Intuitive control panel in luminaire pole for dimming and switching the direct/indirect light separately. Colour temperature 3000K, 3500K or 4000K. Binning initial  $\leq$  MacAdam 3. Colour rendering CRI>80 or CRI>90. Rectangular base plate made of steel, colour matching luminaire body.

**FR** Lampadaire LED. Éclairage direct/indirect. Corps du luminaire en profilé aluminium et épaisseur minimaliste. Surface anodisée ou laquée blanc, graphite, noir, champagne ou polie. Autres options de finition voir Lightnet-Surface-Collection ou RAL au choix. Diffuseur microprismatique avec réduction optimisée de l'éblouissement, spécialement pour les postes de travail avec une transmission lumineuse uniforme et améliorée. Commande intuitive sur le mât du luminaire pour une graduation séparée l'allumage Direct et Indirect. Température de couleur 3000K, 3500K ou 4000K. Binning initial  $\leq$  MacAdam 3. Rendu de couleur CRI>80 ou CRI>90. Pied du luminaire en acier, couleur au choix adaptée au corps du luminaire.

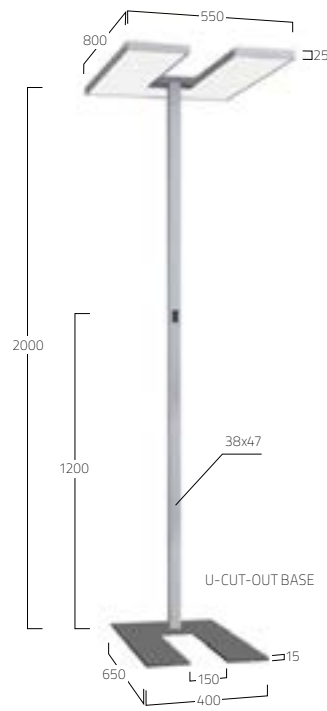

**PRODUCT-CODE:** C F8 A B X - 8 30 M - L800 - U

PRODUCT FAMILY	- C. Cubic
TYPE	- F8 Floor Direct-Indirect
OPTICAL SYSTEM	- A Microprismatic
SURFACE FINISH	- W: Snow White, E: Silver Anodised, U: Urban Graphite, B: Jet Black, H: Champagne Silver, P: Polished Aluminium
CONTROL GEAR	- X: Separately Dimmable
COLOUR REND.	- 8: CRI>80, 9: CRI>90, F: Full Spectrum
COLOUR TEMP.	- 30: 3000K, 35: 3500K, 40: 4000K
POWER	- M: Medium Power, H: High Power
SIZE	- L800: Head Length in mm
BASE	- U: U-Cut-Out



MICROPRISMATIC | DIRECT-INDIRECT

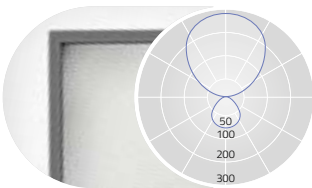

UGR $\leq$ 19 (X=4H, Y=8H, S=0.25H)  
DIRECT: ca.20% INDIRECT ca.80%

L mm	Lumen/Watt Medium Power	Lumen/Watt High Power
800	16360lm/112W	21520lm/152W

Lumen Values: Luminaire luminous flux at 4000K/CRI>80. Other configurations on request.



SEPARATELY DIMMABLE

BASE WITH U-CUT-OUT



# MATRIC 38MM LENS LOUVER FLOOR

LIGHTNET SHOWROOM, COLOGNE, GERMANY  
MATRIC-F7

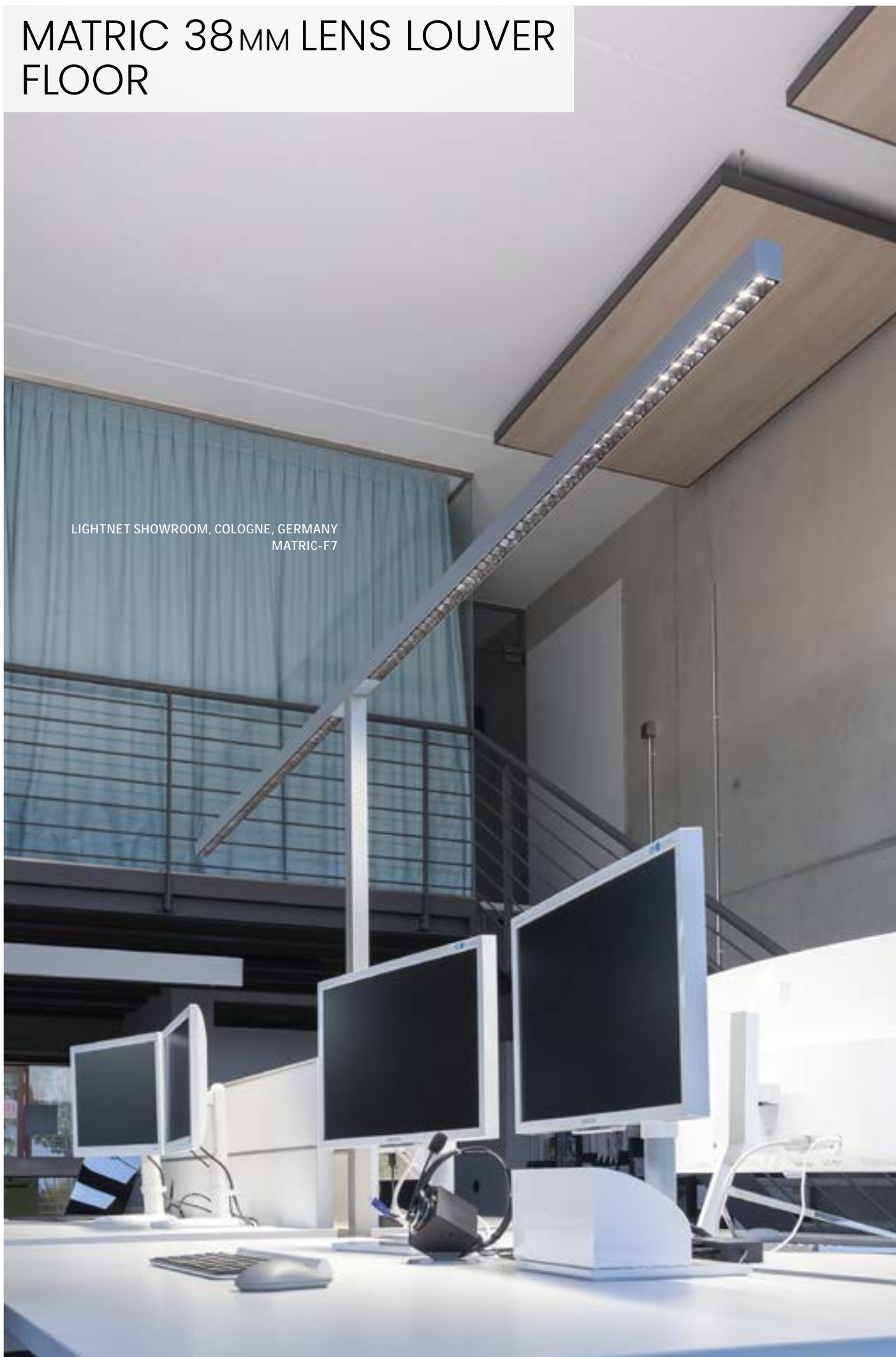

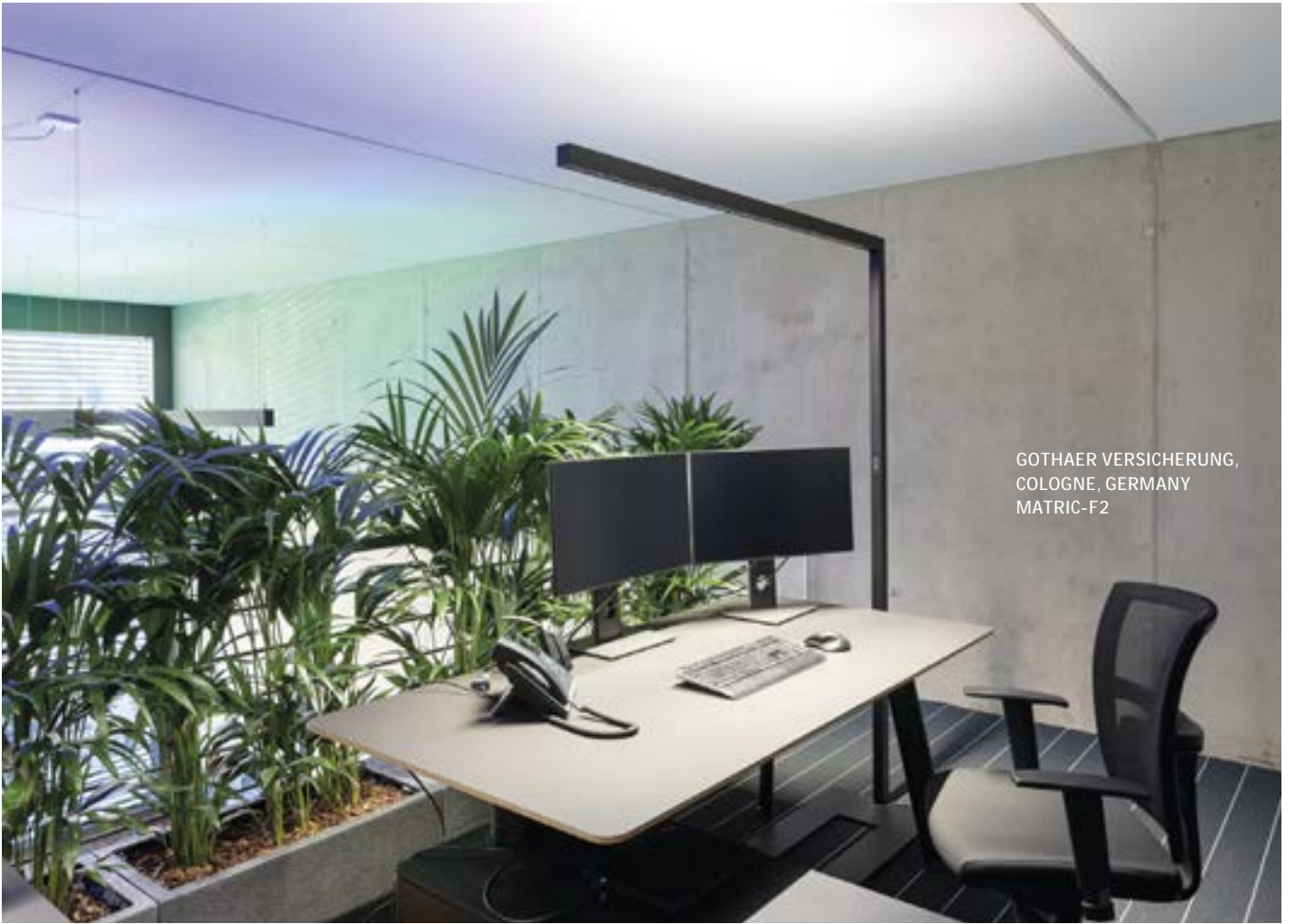

GOTHAER VERSICHERUNG,  
COLOGNE, GERMANY  
MATRIC-F2



MATRIC 38<sub>MM</sub> LENS LOUVER  
FLOOR | F2



**DE** LED-Arbeitsplatzleuchte. Direkt- indirektstrahlend. Leuchtenkörper aus Aluminiumprofil. Oberfläche weiß, silber, graphit, schwarz, champagner oder kupferfarben lackiert. Weitere Oberflächeoptionen siehe Lightnet-Surface-Collection oder RAL nach Wahl. Direktanteil über Präzisionslinsen mit Abblendraster für breite rotationssymmetrische Lichtstärkeverteilung bei gleichzeitig hoher Blendungsbegrenzung (UGR<16). Raster in verschiedenen Farbkombinationen erhältlich. Intuitives Bedienfeld im Leuchtenmast für getrennt stufenlose Dimmung und Schaltung der Kammern für Direkt-/ Indirektlicht, alternativ gemeinsame Steuerung über modernste Sensor- oder Schwarmtechnologie. Rechteckige Fußplatte aus Stahl mit U- oder Side-Cut-Out für unterschiedliche Tischausführungen, Lackierung passend Leuchtenkörper.

**EN** LED task light. Direct-indirect light distribution. Luminaire body made of aluminum profile. Surface white, silver, graphite, black, champagne or copper coated. Further surface options see Lightnet-Surface-Collection or RAL of your choice. Direct part using precision lenses with louvre for wide rotationally symmetrical light distribution with high glare limitation (UGR<16). Louvre available in various colour combinations. Intuitive control panel in luminaire pole for dimming and switching the direct/indirect light separately, alternatively together controllable via state-of-the-art sensor or swarm technology. Rectangular base plate made of steel with U- or Side Cut-Out for different table designs, colour matching luminaire body.

**FR** Lampe de bureau LED. Éclairage direct/indirect. Corps du luminaire en profilé aluminium. Surface laquée blanc, argent, graphite, noir, champagne ou cuivre. Autres options de finition voir Lightnet-Surface-Collection ou RAL au choix. Éclairage direct partiel par lentilles de précision avec grille antiéblouissement pour une large répartition symétrique de l'intensité lumineuse et facteur d'antiéblouissement très bas (UGR<16). Grille antiéblouissement disponible en plusieurs combinaisons de couleurs. Commande intuitive sur le mât du luminaire pour une graduation séparée l'allumage Direct et Indirect, alternative de gestion groupée au travers de la technologie moderne de sensor/cellule ou swarm control. Pied du luminaire en forme de U rectangulaire ou découpe latérale Side-Cut-Out pour différents modèles de bureaux et applications, couleur au choix adaptée au corps du luminaire.



LENS LOUVER | DIRECT-INDIRECT

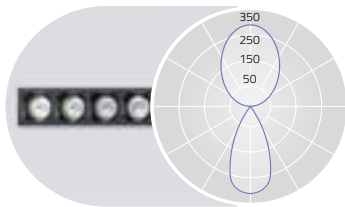

UGR<10 (X=4H, Y=8H, S=0.25H)  
DIRECT: 25% INDIRECT: 75%

Power	Lumen/Watt
Medium Power	11050lm/95W

**PRODUCT-CODE:** L F2 L S X - 8 30 M - L1570 - U B

PRODUCT FAMILY	L: Matric
TYPE	F2: Floor Version
OPTICAL SYSTEM	L: Lens Louver
SURFACE FINISH	W: Snow White, V: Ivory White, S: Radiant Silver, U: Urban Graphite, B: Jet Black, H: Champagne Silver, K: Satin Copper, A: Satin Silver
CONTROL GEAR	X: Separately Dimmable, M: Multisensor Control
COLOUR REND.	8: CRI>80
COLOUR TEMP.	27: 2700K, 30: 3000K, 40: 4000K
POWER	M: Medium Power
SIZE	L1570: Length in mm
BASE	S: Side Cut-Out, U: U-Cut-Out
REFLECTOR	W: Snow White, C: Specular Chrome, B: Jet Black, A: Satin Silver, H: Champagne Silver, K: Satin Copper, G: Satin Gold, N: Satin Platinum



MULTISENSOR DAYLIGHT & PRESENCE

SEPARATELY DIMMABLE



SNOW WHITE

SNOW WHITE / SPECULAR CHROME

SNOW WHITE / JET BLACK

IVORY WHITE / CHAMPAGNE SILVER

IVORY WHITE / SATIN GOLD

IVORY WHITE / SATIN COPPER

SATIN SILVER / JET BLACK

SATIN SILVER / SPECULAR CHROME

JET BLACK / JET BLACK

JET BLACK / CHAMPAGNE SILVER

JET BLACK / SATIN GOLD

CHAMPAGNE SILVER



MATRIC 38<sub>MM</sub> LENS LOUVER  
FLOOR | F7



**DE** LED-Arbeitsplatzleuchte. Direkt- indirektstrahlend. Leuchtenkörper aus Aluminiumprofil. Oberfläche weiß, silber, graphit, schwarz, champagner oder kupferfarben lackiert. Weitere Oberflächenoptionen siehe Lightnet-Surface-Collection oder RAL nach Wahl. Direktanteil über Präzisionslinsen mit Abblendraster für breite rotationsymmetrische Lichtstärkeverteilung bei gleichzeitig hoher Blendbegrenzung (UGR<16). Raster in verschiedenen Farbkombinationen erhältlich. Intuitives Bedienfeld im Leuchtenmast für getrennt stufenlose Dimmung und Schaltung der Kammern für Direkt-/ Indirektlicht, alternativ gemeinsame Steuerung über modernste Sensor- oder Schwarmtechnologie. Rechteckige Fußplatte aus Stahl mit H-Cut-Out für unterschiedliche Tischausführungen, Lackierung passend Leuchtenkörper.

**EN** LED task light. Direct-indirect light distribution. Luminaire body made of aluminum profile. Surface white, silver, graphite, black, champagne or copper coated. Further surface options see Lightnet-Surface-Collection or RAL of your choice. Direct part using precision lenses with louvre for wide rotationally symmetrical light distribution with high glare limitation (UGR<16). Louvre available in various colour combinations. Intuitive control panel in luminaire pole for dimming and switching the direct/indirect light separately, alternatively together controllable via state-of-the-art sensor or swarm technology. Rectangular base plate made of steel with H-Cut-Out for different table designs, colour matching luminaire body.

**FR** Lampe de bureau LED. Éclairage direct/indirect. Corps du luminaire en profilé aluminium. Surface laquée blanc, argent, graphite, noir, champagne ou cuivre. Autres options de finition voir Lightnet-Surface-Collection ou RAL au choix. Éclairage direct partiel par lentilles de précision avec grille antiéblouissement pour une large répartition symétrique de l'intensité lumineuse et facteur d'antiéblouissement très bas (UGR<16). Grille antiéblouissement disponible en plusieurs combinaisons de couleurs. Commande intuitive sur le mât du luminaire pour une graduation séparée l'allumage Direct et Indirect, alternative de gestion groupée au travers de la technologie moderne de sensor/cellule ou swarm control. Pied du luminaire en forme de H rectangulaire, couleur au choix adaptée au corps du luminaire.

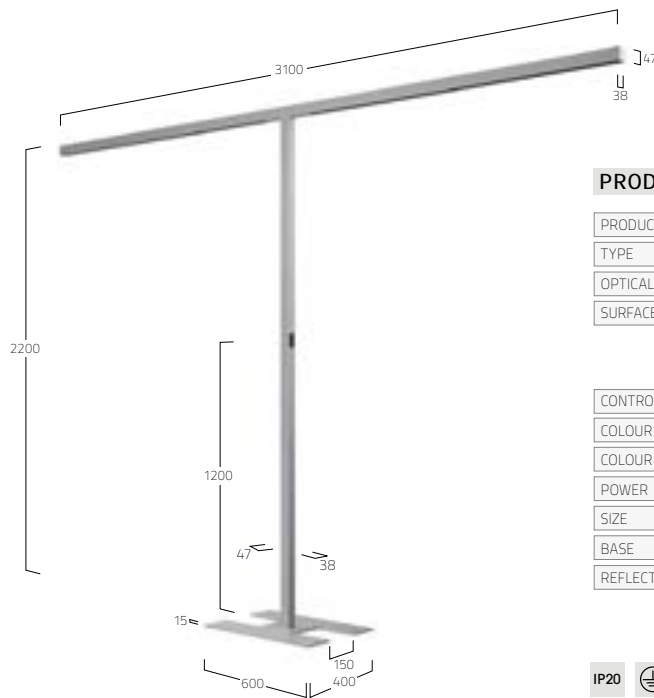

**PRODUCT-CODE:** L F7 L S X - 8 30 M - L3100 - HB

PRODUCT FAMILY	L: Matric
TYPE	F7: Floor Version
OPTICAL SYSTEM	L: Lens Louver
SURFACE FINISH	W: Snow White, V: Ivory White, S: Radiant Silver, U: Urban Graphite, B: Jet Black, H: Champagne Silver, K: Satin Copper, A: Satin Silver
CONTROL GEAR	X: Separately Dimmable, M: Multisensor Control
COLOUR REND.	8: CRI>80
COLOUR TEMP.	27: 2700K, 30: 3000K, 40: 4000K
POWER	M: Medium Power
SIZE	L3100: Length in mm
BASE	H: H-Cut-Out
REFLECTOR	W: Snow White, C: Specular Chrome, B: Jet Black, A: Satin Silver, H: Champagne Silver, K: Satin Copper, N: Satin Platinum, G: Satin Gold



LENS LOUVER | DIRECT-INDIRECT

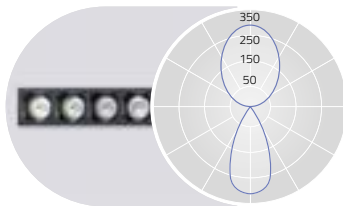

UGR<10 (X=4H, Y=8H, S=0.25H)  
DIRECT: 25% INDIRECT: 75%

Power	Lumen/Watt
Medium Power: for Two Desks	22100lm/190W



MULTISENSOR DAYLIGHT & PRESENCE

SEPARATELY DIMMABLE



SNOW WHITE

SNOW WHITE / SPECULAR CHROME

SNOW WHITE / JET BLACK

IVORY WHITE / CHAMPAGNE SILVER

IVORY WHITE / SATIN GOLD

IVORY WHITE / SATIN COPPER

SATIN SILVER / JET BLACK

SATIN SILVER / SPECULAR CHROME

JET BLACK / JET BLACK

JET BLACK / CHAMPAGNE SILVER

JET BLACK / SATIN GOLD

CHAMPAGNE SILVER



LUCILLE WALL | W1 108



BASIC NEO WALL | A5 114



BASIC NEO WALL | W5 116



BASIC DÉCO WALL | A3 118

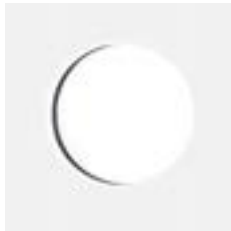

BASIC AMBIENT WALL | A6 120



CALEO WALL | W3 122



CALEO MINI WALL | W4 124



CALEO LINEAR WALL | W4 126



CUBIC EVOLUTION WALL | W4 128



CUBIC EVOLUTION WALL | J4 130



CUBIC EVOLUTION WALL | Y6/X6 132



CUBIC AMBIENT WALL | A7 134



MATRIC 38MM WALL DIRECT-INDIRECT | W1 136



MATRIC 38MM WALL DIRECT | D2 138



MATRIC 38MM WALL INDIRECT | J1 140



MATRIC 55MM WALL DIRECT | D3 142



MATRIC 55MM WALL DIRECT-INDIRECT | W4 144

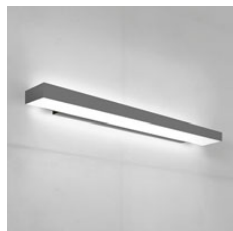

MATRIC 81MM WALL DIRECT-INDIRECT | W5 146

■ WAND | WALL | APPLIQUE

LUCILLE 2.0  
WALL | W1



**DE** LED-Wandleuchte. Microprismenoptik aus Acrylglas für optimierte Entblendung und Lichtlenkung. Minimalistischer Leuchtenkopf mit perfekter homogener und vollflächiger Auflösung der Lichtpunkte. Hochwertiger Pantograf mit Präzisionsgelenken komplett aus Aluminium. Keine sichtbaren Kabel, Federn oder Seile. Oberfläche wahlweise weiß, silber, schwarz oder champagnerfarben lackiert. Intuitive Bedienung über Touchfeld im Leuchtenkopf. Lichtlevel stufenlos dimmbar. Hohe Flexibilität durch seitlich schwenkbares Wandelement. Standard Farbtemperatur 2700K, 3000K oder 4000K. Binning initial  $\leq$  MacAdam 3. Farbwiedergabe CRI>80, alternativ CRI>90.

**EN** LED wall mounted luminaire. Microprismatic made of acrylic glass for optimised glare control and light direction. Minimalistic luminaire head with perfect uniform and enhanced light transmission. High-quality pantograph with precision joints completely made of aluminium. No visible cables, springs or cords. Surface available in white, silver, black or champagne coated. Intuitive control via touch control panel in the luminaire head. Light output level continuously dimmable. High flexibility due to laterally swivelling wall element. Standard colour temperature 2700K, 3000K or 4000K. Binning initial  $\leq$  MacAdam 3. Colour rendering CRI>80, alternatively CRI>90.

**FR** Luminaire en applique/mural LED. Diffuseur/optique microprisme en verre acrylique pour un antiéblouissement et contrôle de la lumière optimal. Tête du luminaire minimaliste avec une distribution parfaitement homogène et sur toute la surface des points lumineux. Pantographe de haute qualité avec articulation de précision complètement en aluminium. Pas de câbles, ressorts ou fils visibles. Surface/finition thermolaqué au choix en couleur blanc, argent, noir ou champagne. Commande de contrôle intuitive tactile dans la tête du luminaire. Niveau d'éclairage dimmable en continu sans coupures. Haute flexibilité grâce à un élément mural et latéral orientable. Température de couleur 2700K, 3000K ou 4000K. Binning initial  $\leq$  MacAdam 3. Indice du rendu de couleur IRC>80, alternative IRC>90.



**PRODUCT-CODE:** U W1 A A S - 8 30 M - D150 - C

PRODUCT FAMILY	U: Lucille
TYPE	W1: Wall mounted [Two-Arms]
OPTICAL SYSTEM	A: Microprismatic
SURFACE FINISH	V: Ivory White, A: Satin Silver, B: Jet Black, H: Champagne Silver
CONTROL GEAR	S: Switch & Dim
COLOUR REND.	8: CRI>80, 9: CRI>90
COLOUR TEMP.	27: 2700K, 30: 3000K, 40: 4000K
POWER	M: Medium Power
SIZE	D150: Head Diameter 150 mm
POWER SUPPLY	C: With Cord, W: Through the Wall



MICROPRISMATIC | DIRECT

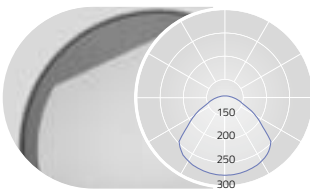

DIRECT: 100%

Lumen/Watt  
Medium Power

750lm/14W

Lumen Values: Luminaire luminous flux at 4000K/CRI>80. Other configurations on request.

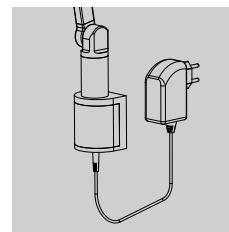

POWER SUPPLY WITH CORD

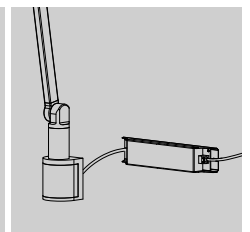

POWER SUPPLY THROUGH THE WALL



IVORY WHITE



SATIN SILVER



JET BLACK



CHAMPAGNE SILVER

# BASIC WALL



RAUMFABRIK KARLSRUHE, GERMANY  
BASIC-A5

PHOTOS: DANIEL VIESER





# BASIC WALL

DEWI BACK, BERLIN, GERMANY  
BASIC-X1



PSI, PLANEGG, GERMANY  
BASIC-X7  
ARCHITECTURE: RICARDO ALVES  
PHOTOS: BECKER LACOUR

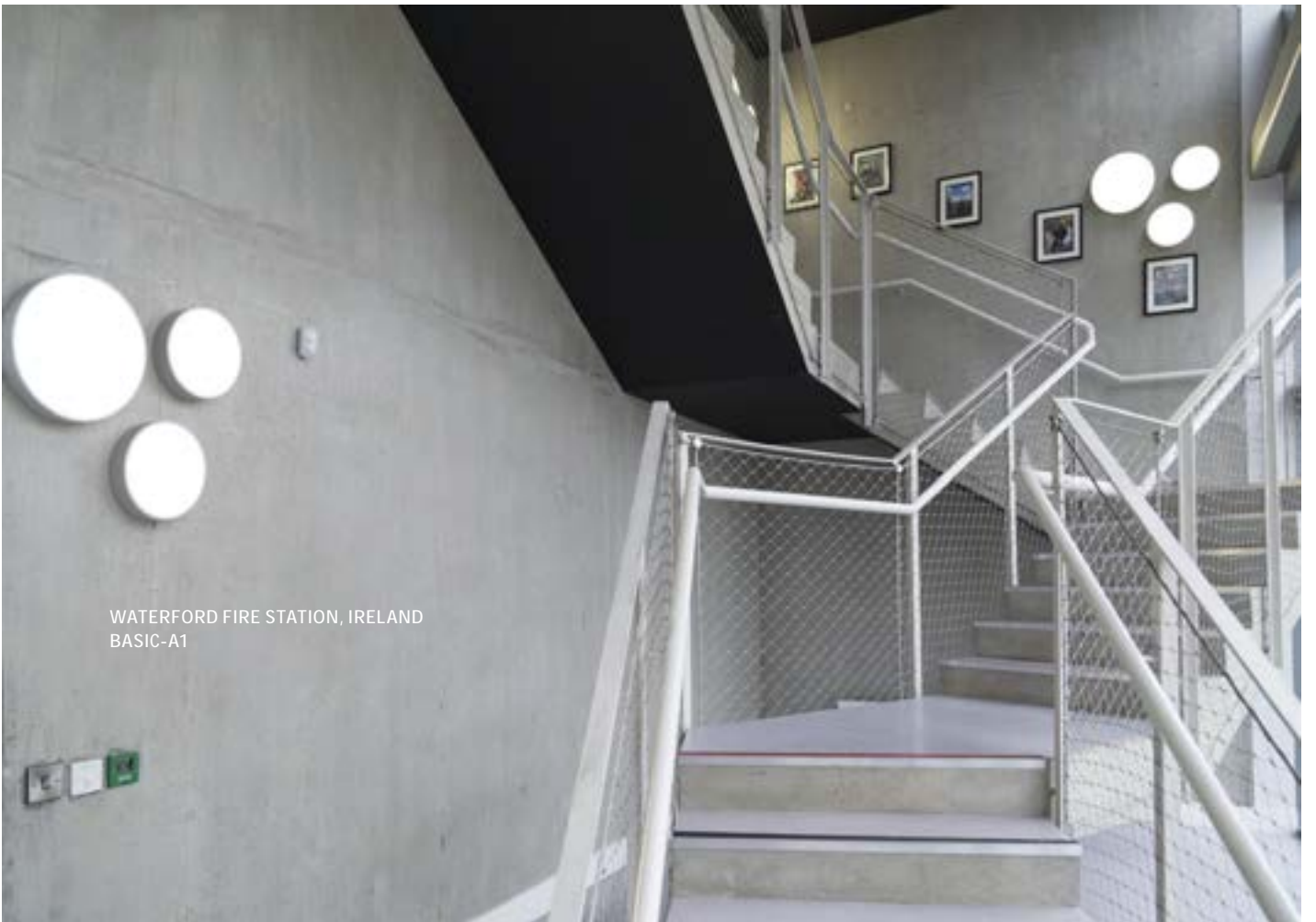

WATERFORD FIRE STATION, IRELAND  
BASIC-A1

BASIC NEO  
WALL | A5



**DE** LED-Anbauleuchte für Wand- oder Deckenmontage. Rein direktstrahlend. Leuchtenkörper aus Aluminiumprofil mit filigraner Bauhöhe von 38mm ohne zusätzliche Distanzelemente. Oberfläche weiß, silber, graphit, schwarz, champagner oder kupferfarben lackiert. Weitere Oberflächenoptionen siehe Lightnet-Surface-Collection oder RAL nach Wahl. Microprismenoptik mit optimierter Blendungsbegrenzung speziell für Office-Anwendungen. Satinierter Opaldiffusor für Allgemeinbeleuchtung mit max. Transmissionsgrad und homogener Lichtpunktauflösung. Konverter in Leuchtgehäuse integriert, wahlweise einfach schaltbar oder stufenlos dimmbar (1-10V, DALI, Touch-Dim, Casambi). Farbtemperaturen 2200K, 2700K, 3000K, 3500K, 4000K oder 6500K. Binning initial  $\leq$  MacAdam 3. Colour rendering CRI>80 oder CRI>90. Auf Anfrage: Integration von Notlichtkomponenten, Sensortechnologie.

**EN** LED surface-mounted luminaire for walls or ceilings. Direct only light distribution. Luminaire body made of aluminium profile with filigree overall height of 38mm without additional spacers. Surface white, silver, graphite, black, champagne or copper coated. Further surface options see Lightnet-Surface-Collection or RAL of your choice. Microprismatic with optimized glare reduction especially for workplaces. Satin opal diffuser for general lighting with maximum transmittance and homogeneous lighting. Converter integrated into luminaire housing, optionally switchable or dimmable (1-10V, DALI, Touch-Dim, Casambi). Colour temperatures 2200K, 2700K, 3000K, 3500K, 4000K or 6500K. Binning initial  $\leq$  MacAdam 3. Colour rendering CRI>80 or CRI>90. On request: Integration of emergency lighting components, sensor technology.

**FR** Luminaire LED en saillie pour murs et plafonds. Éclairage seulement direct. Corps du luminaire en profilé aluminium avec une épaisseur fine de 38mm sans espacements/entretoises supplémentaires. Surface laquée blanc, argent, graphite, noir, champagne ou cuivre. Autres options de finition voir Lightnet-Surface-Collection ou RAL au choix. Diffuseur microprismatique optimisé pour un éblouissement limité et adapté aux bureaux. Diffuseur opale satiné pour un éclairage général et une transmission maximale et homogène. Driver intégré dans le luminaire, au choix ON/OFF ou graduable (1-10V, DALI, Touch-Dim, Casambi). Température de couleur 2200K, 2700K, 3000K, 3500K, 4000K ou 6500K. Binning initial  $\leq$  MacAdam 3. Rendu de couleur CRI>80 ou CRI>90. Sur demande: Intégration de composants d'éclairage de secours ou de capteurs.



**PRODUCT-CODE:** B A5 O S D - 8 30 M - D400

- PRODUCT FAMILY - **B**: Basic
- TYPE - **A5**: Direct Only
- OPTICAL SYSTEM - **A**: Microprismatic, **O**: Opal
- SURFACE FINISH - **W**: Snow White, **V**: Ivory White, **S**: Radiant Silver, **U**: Urban Graphite, **B**: Jet Black, **H**: Champagne Silver, **K**: Satin Copper
- CONTROL GEAR - **E**: On/Off, **L**: DALI, **D**: 1-10V, **H**: Touch-Dim
- COLOUR REND. - **8**: CRI>80, **9**: CRI>90, **F**: Full Spectrum
- COLOUR TEMP. - **22**: 2200K, **27**: 2700K, **30**: 3000K, **35**: 3500K, **40**: 4000K, **65**: 6500K, **TW**: Tunable White 2700-6500K [D300-D800]
- POWER - **M**: Medium Power, **H**: High Power
- SIZE - Luminaire Diameter in mm: **D200**, **D300**, **D400**, **D500**, **D600**, **D800**
- ON REQUEST - Emergency Module, Casambi



MICROPRISMATIC | DIRECT

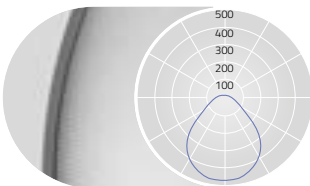

UGR<sub>s</sub>19 for Medium Power (X=4H, Y=8H, S=0.25H)  
DIRECT: 100%

OPAL DIFFUSER | DIRECT

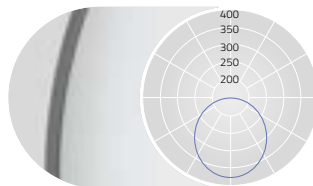

DIRECT: 100%

D mm	Lumen/Watt Medium Power	Lumen/Watt High Power
200	320lm/4W	550lm/6W
300	770lm/7W	1320lm/11W
400	1630lm/12W	2670lm/19W
500	2370lm/16W	3970lm/28W
600	3770lm/25W	6130lm/42W
800	5900lm/40W	7920lm/54W

D mm	Lumen/Watt Medium Power	Lumen/Watt High Power
200	330lm/4W	560lm/6W
300	780lm/7W	1330lm/11W
400	1650lm/12W	2700lm/19W
500	2410lm/16W	4030lm/28W
600	3840lm/25W	6240lm/42W
800	6040lm/40W	8100lm/54W

Lumen Values: Luminaire luminous flux at 4000K/CRI>80. Other configurations on request.



EMERGENCY MODULE



SNOW WHITE

RADIANT SILVER

URBAN GRAPHITE

JET BLACK

CHAMPAGNE SILVER

SATIN COPPER

BASIC NEO  
WALL | W5



**DE** LED-Wand-Anbauleuchte. Direkt-indirektstrahlend. Leuchtenkörper aus Aluminiumprofil mit filigraner Bauhöhe von 35mm ohne zusätzliche Distanzelemente. Oberfläche weiß, silber, graphit, schwarz, champagner oder kupferfarben lackiert. Weitere Oberflächenoptionen siehe Lightnet-Surface-Collection oder RAL nach Wahl. Microprismenoptik mit optimierter Blendungsbegrenzung speziell für Office-Anwendungen. Satinierter Opaldiffusor für Allgemeinbeleuchtung mit max. Transmissionsgrad und homogener Lichtpunktauflösung. Konverter in Leuchtgehäuse integriert, wahlweise einfach schaltbar oder stufenlos dimmbar (1-10V, DALI, Touch-Dim). Farbtemperaturen 2200K, 2700K, 3000K, 3500K, 4000K oder 6500K. Binning initial  $\leq$  MacAdam 3. Farbwiedergabe CRI>80 oder CRI>90. Durchdachtes Montagesystem für einfache Installation und stabilen Halt.

**EN** LED wall mounted luminaire. Direct-indirect light distribution. Luminaire body made of aluminium profile with filigree overall height of 35mm without additional spacers. Surface white, silver, graphite, black, champagne or copper coated. Further surface options see Lightnet-Surface-Collection or RAL of your choice. Microprismatic with optimized glare reduction especially for workplaces. Satin opal diffuser for general lighting with maximum transmittance and homogeneous lighting. Driver integrated into luminaire housing, optionally switchable or dimmable (1-10V, DALI, Touch-Dim). Colour temperatures 2200K, 2700K, 3000K, 3500K, 4000K or 6500K. Binning initial  $\leq$  MacAdam 3. Colour rendering CRI>80 or CRI>90. Sophisticated mounting system for easy installation and stable hold.

**FR** Applique murale LED. Éclairage direct/indirect. Corps du luminaire en profilé aluminium avec une épaisseur fine de 35mm sans espacements/entretoises supplémentaires. Surface laquée blanc, argent, graphite, noir, champagne ou cuivre. Autres options de finition voir Lightnet-Surface-Collection ou RAL au choix. Diffuseur microprismatique optimisé pour un éblouissement limité et adapté aux bureaux. Diffuseur opale satiné pour un éclairage général et une transmission maximale et homogène. Driver intégré dans le luminaire, au choix ON/OFF ou graduable (1-10V, DALI, Touch-Dim). Température de couleur 2200K, 2700K, 3000K, 3500K, 4000K ou 6500K. Binning initial  $\leq$  MacAdam 3. Rendu de couleur CRI>80 ou CRI>90. Système de montage sophistiqué pour une installation facile et stable.

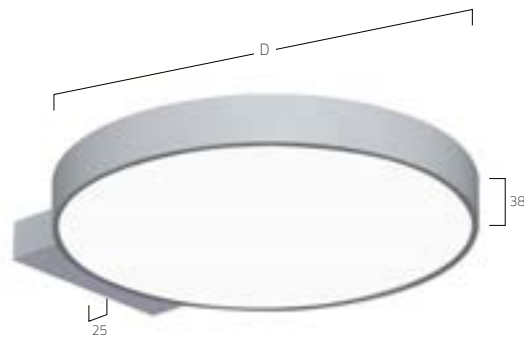

**PRODUCT-CODE:** **B W5 O S D - 8 30 M - D300**

PRODUCT FAMILY	- B Basic
TYPE	- W5 Direct-Indirect
OPTICAL SYSTEM	- A Microprismatic, O Opal
SURFACE FINISH	- W Snow White, V Ivory White,
	S Radiant Silver, U Urban Graphite, B Jet Black,
	H Champagne Silver, K Satin Copper
CONTROL GEAR	- E On/Off, L DALI, D 1-10V, H Touch-Dim
COLOUR REND.	- 8 CRI>80, 9 CRI>90, F Full Spectrum
COLOUR TEMP.	- 22 2200K, 27 2700K, 30 3000K, 35 3500K, 40 4000K,
	65 6500K, TW Tunable White 2700-6500K
POWER	- M Medium Power, H High Power
SIZE	- Luminaire Diameter in mm: D300



**MICROPRISMATIC | DIRECT-INDIRECT**

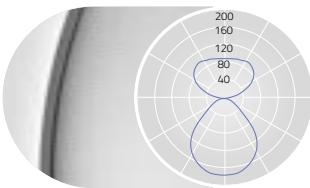

UGR $\leq$ 19 (X=4H, Y=8H, S=0.25H)  
DIRECT: ca.55% INDIRECT ca.45%

D mm	Lumen/Watt Medium Power	Lumen/Watt High Power
300	1410lm/11W	2390lm/19W

**OPAL DIFFUSER | DIRECT-INDIRECT**

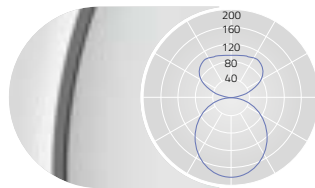

DIRECT: ca.55% INDIRECT ca.45%

D mm	Lumen/Watt Medium Power	Lumen/Watt High Power
300	1420lm/11W	2400lm/19W

Lumen Values: Luminaire luminous flux at 4000K/CRI>80. Other configurations on request.



BASIC DÉCO  
WALL | A3



**DE** LED-Anbauleuchte für Wand- und Deckenmontage. Rein direktstrahlend. Leuchtenkörper aus Aluminiumprofil mit Bauhöhe 58mm in. Gehäuse-Außenfläche und dekorativer Reflektorring in unterschiedlichen Lackierungen und Kombinationen erhältlich, z.B. weiß, silber, graphit, schwarz, gold oder kupferfarben. Zu Oberflächenoptionen- und Kombinationen siehe Lightnet-Surface-Collection oder Bi-Colour-Auswahl. Rückversetzte Microprismenoptik mit optimierter Blendungsbegrenzung speziell für Office-Anwendungen. Satinierter Opaldiffusor für Allgemeinbeleuchtung mit max. Transmissionsgrad und homogener Lichtpunktauflösung. Konverter in Leuchtgehäuse integriert, wahlweise einfach schaltbar oder stufenlos dimmbar (1-10V, DALI, Touch-Dim, Casambi). Farbtemperaturen 2200K, 2700K, 3000K, 3500K, 4000K oder 6500K. Binning initial  $\leq$  MacAdam 3. Farbwiedergabe CRI>80 oder CRI>90.

**EN** LED surface-mounted luminaire for walls and ceilings. Direct only light distribution. Luminaire body made of aluminium profile with overall height of 58mm. Outer housing and decorative reflector ring available in various finishes and combinations, e.g. white, silver, graphite, black, gold or copper coated. For surface options and combinations check Lightnet Surface Collection or Bi-Colour Selection. Recessed Microprismatic with optimized glare reduction especially for workplaces. Satin opal diffuser for general lighting with maximum transmittance and homogeneous lighting. Driver integrated into luminaire housing, optionally switchable or dimmable (1-10V, DALI, Touch-Dim, Casambi). Colour temperatures 2200K, 2700K, 3000K, 3500K, 4000K or 6500K. Binning initial  $\leq$  MacAdam 3. Colour rendering CRI>80 or CRI>90.

**FR** Luminaire LED en saillie pour murs et plafonds. Éclairage seulement direct. Corps du luminaire en profilé aluminium avec une hauteur de 58mm. Surface du luminaire et réflecteur/bague décorative disponible en différentes combinaisons et couleurs au choix, Ex: blanc, argent, graphite, noir ou cuivre. Pour les options et combinaisons de finitions, voir Lightnet Surface Collection ou Bi-Colour Selection. Diffuseur microprismatique encastré avec réduction optimisée de l'éblouissement, spécialement pour les postes de travail. Diffuseur opale satiné pour un éclairage général et une transmission maximale et homogène. Driver intégré dans le luminaire, au choix ON/OFF ou graduable (1-10V, DALI, Touch-Dim, Casambi). Température de couleur 2200K, 2700K, 3000K, 3500K, 4000K ou 6500K. Binning initial  $\leq$  Mac Adam 3. Rendu de couleur CRI>80 ou CRI>90.



**PRODUCT-CODE:** **B A3 O S D - 8 30 M - D400 - S**

- PRODUCT FAMILY - **B**: Basic
- TYPE - **A3**: Direct Only
- OPTICAL SYSTEM - **A**: Microprismatic, **O**: Opal
- SURFACE FINISH - **W**: Snow White, **V**: Ivory White, **S**: Radiant Silver, **U**: Urban Graphite, **B**: Jet Black, **H**: Champagne Silver, **K**: Satin Copper
- CONTROL GEAR - **E**: On/Off, **L**: DALI, **D**: 1-10V, **H**: Touch-Dim
- COLOUR REND. - **8**: CRI>80, **9**: CRI>90, **F**: Full Spectrum
- COLOUR TEMP. - **22**: 2200K, **27**: 2700K, **30**: 3000K, **35**: 3500K, **40**: 4000K, **65**: 6500K, **TW**: Tunable White 2700-6500K [D300-D800]
- POWER - **M**: Medium Power, **H**: High Power
- SIZE - Luminaire Diameter in mm: **D200**, **D300**, **D400**, **D500**, **D600**, **D800**
- REFLECTOR - **W**: Snow White, **V**: Ivory White, **S**: Radiant Silver, **U**: Urban Graphite, **B**: Jet Black, **H**: Champagne Silver, **K**: Satin Copper, **G**: Satin Gold
- ON REQUEST - Emergency Module, Casambi

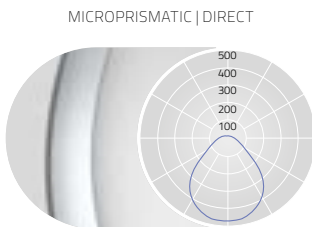

UGR<sub>s</sub>19 for Medium Power (X=4H, Y=8H, S=0.25H)  
DIRECT: 100%

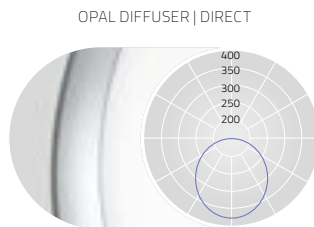

DIRECT: 100%

D mm	Lumen/Watt Medium Power	Lumen/Watt High Power
200	300lm/4W	600lm/6W
300	920lm/8W	1590lm/13W
400	1750lm/14W	2760lm/21W
500	2730lm/22W	4510lm/36W
600	3950lm/28W	5810lm/42W
800	5960lm/43W	7360lm/54W

D mm	Lumen/Watt Medium Power	Lumen/Watt High Power
200	270lm/4W	550lm/6W
300	900lm/8W	1560lm/13W
400	1750lm/14W	2760lm/21W
500	2750lm/22W	4570lm/36W
600	4050lm/28W	5920lm/42W
800	6120lm/43W	7560lm/54W

Lumen Values: Luminaire luminous flux at 4000K/CRI>80. Other configurations on request.





BASIC AMBIENT  
WALL | A6



**DE** LED-Anbauleuchte für Wand- oder Deckenmontage. Direkt-rundumstrahlend für dezente Wandaufhellung. Leuchtenkörper aus Aluminiumprofil und Diffusor mit 60mm Bauhöhe. Ambientdiffusor aus satinierem Acrylglas für Allgemeinbeleuchtung. Oberfläche weiß, silber, graphit, schwarz, champagner oder kupferfarben lackiert. Weitere Oberflächenoptionen siehe Lightnet-Surface-Collection oder RAL nach Wahl. Converter in Leuchtengehäuse integriert, wahlweise einfach schaltbar oder stufenlos dimmbar (1-10V, DALI, Touch-Dim, Casambi). Farbtemperaturen 2200K, 2700K, 3000K, 3500K, 4000K oder 6500K. Binning initial ≤ MacAdam 3. Farbwiedergabe CRI>80 oder CRI>90. Auf Anfrage: Integration von Notlichtkomponenten, Sensortechnologie.

**EN** LED surface-mounted luminaire for walls or ceilings. Omnidirectional light distribution for discreet illumination of the wall. Luminaire body made of aluminium profile and diffuser with overall height of 60mm. Ambient diffuser made of frosted acrylic glass for general lighting. Surface white, silver, graphite, black, champagne or copper coated. Further surface options see Lightnet-Surface-Collection or RAL of your choice. Converter integrated into luminaire housing, optionally switchable or dimmable (1-10V, DALI, Touch-Dim, Casambi). Colour temperatures 2200K, 2700K, 3000K, 3500K, 4000K or 6500K. Binning initial ≤ MacAdam 3. Colour rendering CRI>80 or CRI>90. On request: Integration of emergency lighting components, sensor technology.

**FR** Luminaire LED en saillie pour murs et plafonds. Distribution lumineuse omnidirectionnelle pour un éclairage discret du mur. Corps du luminaire en profilé aluminium avec diffuseur de 60mm de hauteur. Diffuseur AMBIENT en verre satiné acrylique pour diverses applications d'éclairage. Surface laquée blanc, argent, graphite, noir, champagne ou cuivre. Autres options de finition voir Lightnet-Surface-Collection ou RAL au choix. Driver intégré dans le luminaire, au choix ON/OFF ou graduable (1-10V, DALI, Touch-Dim, Casambi). Température de couleur 2200K, 2700K, 3000K, 3500K, 4000K ou 6500K. Binning initial ≤ MacAdam 3. Rendu de couleur CRI>80 ou CRI>90. Sur demande: Intégration de composants d'éclairage de secours ou de capteurs.



PRODUCT-CODE:		B A6 F S D - 8 30 M - D300	
PRODUCT FAMILY	- B Basic		
TYPE	- A6 Direct Only		
OPTICAL SYSTEM	- F Ambient		
SURFACE FINISH	- W: Snow White, V: Ivory White,		
	S: Radiant Silver, U: Urban Graphite, B: Jet Black,		
	H: Champagne Silver, K: Satin Copper		
CONTROL GEAR	- E: On/Off, L: DALI, D: 1-10V, H: Touch-Dim, C: Casambi		
COLOUR REND.	- 8: CRI>80, 9: CRI>90, F: Full Spectrum		
COLOUR TEMP.	- 22: 2200K, 27: 2700K, 30: 3000K, 35: 3500K, 40: 4000K,		
	65: 6500K, TW: Tunable White 2700-6500K [D500-D600]		
POWER	- M: Medium Power, H: High Power		
SIZE	- Luminaire Diameter in mm: D300 D400 D500 D600		
ON REQUEST	- Emergency Module		

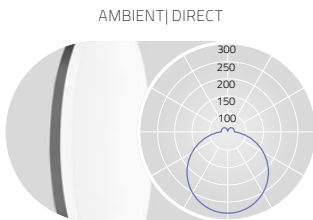

DIRECT: ca.98% INDIRECT: ca.2%

D mm	Lumen/Watt Medium Power	Lumen/Watt High Power
300	920lm/8W	1810lm/16W
400	1830lm/13W	3760lm/26W
500	2600lm/18W	5150lm/36W
600	4080lm/28W	7600lm/53W

Lumen Values: Luminaire luminous flux at 4000K/CRI>80. Other configurations on request.



CALEO  
WALL | W3

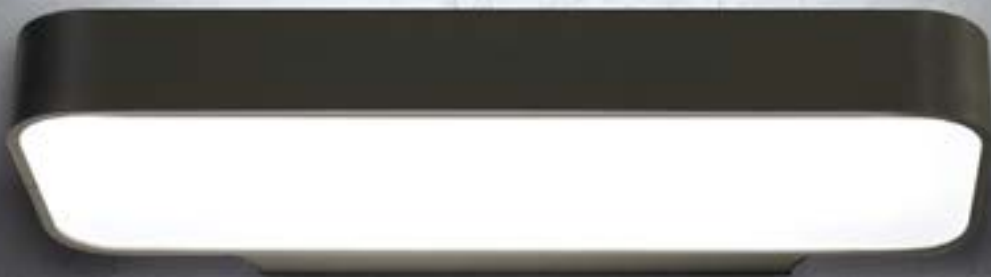

**DE** LED-Wand-Anbauleuchte. Direkt-indirektstrahlend. Leuchtenkörper aus Aluminiumprofil. Oberfläche silber, weiß, graphit, schwarz, champagner oder kupferfarben lackiert. Weitere Oberflächenoptionen siehe Lightnet-Surface-Collection oder RAL nach Wahl. Microprismenoptik mit optimierter Blendungsbegrenzung speziell für Office-Anwendungen. Satinierter Opaldiffusor für Allgemeinbeleuchtung. Konverter in Leuchtengehäuse integriert, wahlweise einfach schaltbar oder stufenlos dimmbar (1-10V, DALI, Touch-Dim, Casambi). Farbtemperaturen 2200K, 2700K, 3000K, 3500K, 4000K oder 6500K. Binning initial  $\leq$  MacAdam 3. Farbwiedergabe  $a > 80$  oder CRI  $> 90$ .

**EN** LED wall mounted luminaire. Direct-indirect light distribution. Luminaire body made of aluminum profile. Surface silver, white, graphite, black, champagne or copper coated. Further surface options see Lightnet-Surface-Collection or RAL of your choice. Microprismatic with optimized glare reduction especially for workplaces. Satin opal diffuser for general lighting. Converter integrated into luminaire housing, optionally switchable or dimmable (1-10V, DALI, Touch-Dim, Casambi). Colour temperatures 2200K, 2700K, 3000K, 3500K, 4000K or 6500K. Binning initial  $\leq$  MacAdam 3. Colour rendering CRI  $> 80$  or CRI  $> 90$ .

**FR** Applique murale LED. Éclairage direct/indirect. Corps du luminaire en profilé aluminium. Surface laquée argent, blanc, graphite, noir, champagne ou cuivre. Autres options de finition voir Lightnet-Surface-Collection ou RAL au choix. Diffuseur microprismatique optimisé pour un éblouissement limité et adapté aux bureaux. Diffuseur opale satinée pour un éclairage général. Driver intégré dans le luminaire, au choix ON/OFF ou graduable (1-10V, DALI, Touch-Dim, Casambi). Température de couleur 2200K, 2700K, 3000K, 3500K, 4000K ou 6500K. Binning initial  $\leq$  MacAdam 3. Rendu de couleur CRI  $> 80$  ou CRI  $> 90$ .

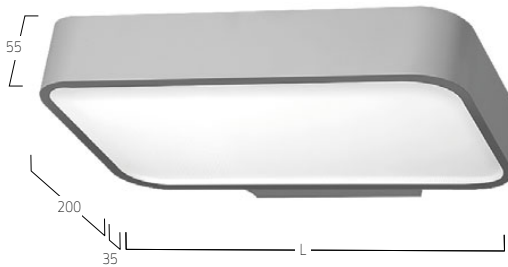

**PRODUCT-CODE:** A W3 O S E - 8 30 M - L320

PRODUCT FAMILY	- A: Caleo
TYPE	- W3: Wall Direct-Indirect
OPTICAL SYSTEM	- O: Opal, A: Microprismatic
SURFACE FINISH	- W: Snow White, S: Radiant Silver, U: Urban Graphite, B: Jet Black, H: Champagne Silver, K: Satin Copper
CONTROL GEAR	- E: On/Off, L: DALI, D: 1-10V, H: Touch-Dim, C: Casambi
COLOUR REND.	- 8: CRI $> 80$ , 9: CRI $> 90$ , F: Full Spectrum
COLOUR TEMP.	- 22: 2200K, 27: 2700K, 30: 3000K, 35: 3500K, 40: 4000K, 65: 6500K
POWER	- M: Medium Power, H: High Power
SIZE	- Luminaire length in mm: L320 L610



MICROPRISMATIC | DIRECT-INDIRECT



DIRECT: ca.35% INDIRECT ca.65%

L mm	Lumen/Watt Medium Power	Lumen/Watt High Power
320	2350lm/21W	3400lm/32W
610	3970lm/33W	5610lm/50W

OPAL DIFFUSER | DIRECT-INDIRECT

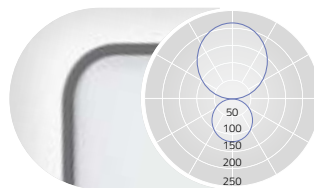

DIRECT: ca.35% INDIRECT ca.65%

L mm	Lumen/Watt Medium Power	Lumen/Watt High Power
320	2370lm/21W	3430lm/32W
610	4020lm/33W	5680lm/50W

Lumen Values: Luminaire luminous flux at 4000K/CRI  $> 80$ . Other configurations on request.



CALEO MINI  
WALL | W4



**DE** LED-Wand-Anbauleuchte. Direkt-indirektstrahlend. Leuchtenkörper aus Aluminiumprofil. Oberfläche silber, weiß, graphit, schwarz, champagner oder kupferfarben lackiert. Weitere Oberflächenoptionen siehe Lightnet-Surface-Collection oder RAL nach Wahl. Opaldiffusor aus satiniertem Acrylglas für Allgemeinbeleuchtung. Konverter in Leuchtengehäuse integriert, einfach schaltbar. Farbtemperaturen 2200K, 2700K, 3000K, 3500K, 4000K, 6500K. Binning initial  $\leq$  Mac Adam 3. Farbwiedergabe  $a > 80$  oder CRI  $> 90$ .

**EN** LED wall mounted luminaire. Direct-indirect light distribution. Luminaire body made of aluminum profile. Surface silver, white, graphite, black, champagne or copper coated. Further surface options see Lightnet-Surface-Collection or RAL of your choice. Opal diffuser made of acrylic glass for general lighting. Converter integrated into luminaire housing, switchable. Colour temperatures 2200K, 2700K, 3000K, 3500K, 4000K or 6500K. Binning initial  $\leq$  MacAdam 3. Colour rendering CRI  $> 80$  or CRI  $> 90$ .

**FR** Applique murale LED. Éclairage direct/indirect. Corps du luminaire en profilé aluminium. Surface laquée argent, blanc, graphite, noir, champagne ou cuivre. Autres options de finition voir Lightnet-Surface-Collection ou RAL au choix. Diffuseur opale en verre acrylique pour éclairage général. Driver intégré dans le corps luminaire, ON/OFF. Température de couleur 2200K, 2700K, 3000K, 3500K, 4000K ou 6500K. Binning initial  $\leq$  MacAdam 3. Rendu de couleur CRI  $> 80$  ou CRI  $> 90$ .

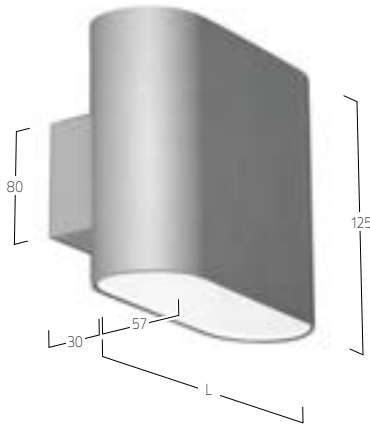

**PRODUCT-CODE:** A W4 O S E - 8 30 M - L152

PRODUCT FAMILY	- A: Caleo
TYPE	- W4: Mini Wall Direct-Indirect
OPTICAL SYSTEM	- O: Opal
SURFACE FINISH	- W: Snow White, S: Radiant Silver, U: Urban Graphite, B: Jet Black, H: Champagne Silver, K: Satin Copper
CONTROL GEAR	- E: On/Off, L: DALI, H: Touch-Dim
COLOUR REND.	- 8: CRI $> 80$ , 9: CRI $> 90$ , F: Full Spectrum
COLOUR TEMP.	- 22: 2200K, 27: 2700K, 30: 3000K, 35: 3500K, 40: 4000K
POWER	- M: Medium Power
SIZE	- Luminaire length in mm: L152



**OPAL**

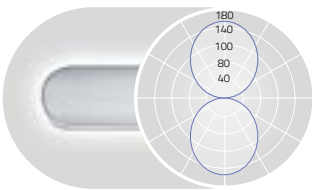

DIRECT: ca.50% INDIRECT ca.50%

L mm	Lumen/Watt Medium Power
152	1000lm/13W

Lumen Values: Luminaire luminous flux at 4000K/CRI  $> 80$ . Other configurations on request.



CALEO LINEAR  
WALL | W4



**DE** LED-Wand-Anbauleuchte. Direkt-indirektstrahlend. Leuchtenkörper aus Aluminiumprofil. Oberfläche silber, weiß, graphit, schwarz, champagner oder kupferfarben lackiert. Weitere Oberflächenoptionen siehe Lightnet-Surface-Collection oder RAL nach Wahl. Micro-prismenoptik mit optimierter Blendungsbegrenzung speziell für Office-Anwendungen. Satinierter Opaldiffusor für Allgemeinbeleuchtung. Konverter in Leuchtgehäuse integriert, wahlweise getrennt schaltbar oder zusammen stufenlos dimmbar (1-10V, DALI, Touch-Dim, Casambi). Farbtemperaturen 2200K, 2700K, 3000K, 3500K, 4000K, 6500K. Binning initial  $\leq$  MacAdam 3. Farbwiedergabe CRI>80 oder CRI>90.

**EN** LED wall mounted luminaire. Direct-indirect light distribution. Luminaire body made of aluminum profile. Surface silver, white, graphite, black, champagne or copper coated. Further surface options see Lightnet-Surface-Collection or RAL of your choice. Microprismatic screen with optimized glare reduction especially for workplaces. Satin opal diffuser for general lighting. Driver integrated into luminaire housing, separately switchable or together dimmable (1-10V, DALI, Touch-Dim, Casambi). Colour temperatures 2200K, 2700K, 3000K, 3500K, 4000K or 6500K. Binning initial  $\leq$  MacAdam 3. Colour rendering CRI>80 or CRI>90.

**FR** Applique murale LED. Éclairage direct/indirect. Corps du luminaire en profilé aluminium. Surface laquée argent, blanc, graphite, noir, champagne ou cuivre. Autres options de finition voir Lightnet-Surface-Collection ou RAL au choix. Diffuseur microprismatique optimisé pour un éblouissement limité et adapté aux bureaux. Diffuseur opale satinée pour un éclairage général. Driver intégré dans le luminaire, au choix ON/OFF ou graduable (1-10V, DALI, Touch-Dim, Casambi). Température de couleur 2200K, 2700K, 3000K, 3500K, 4000K ou 6500K. Binning initial  $\leq$  MacAdam 3. Rendu de couleur CRI>80 ou CRI>90.

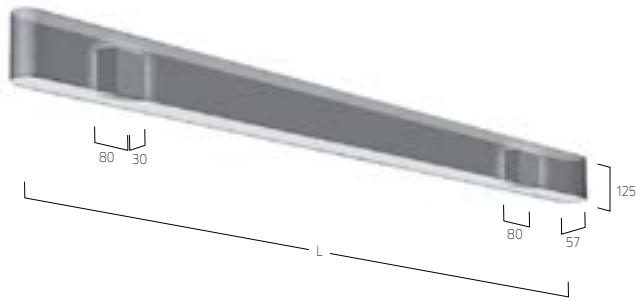

**PRODUCT-CODE:** A W4 O S G - 8 30 M - L894

PRODUCT FAMILY - **A** Caleo  
 TYPE - **W4** Direct-Indirect  
 OPTICAL SYSTEM - **O** Opal, **A** Microprismatic  
 SURFACE FINISH - **W** Snow White, **S** Radiant Silver, **U** Urban Graphite, **B** Jet Black, **H** Champagne Silver, **K** Satin Copper  
 CONTROL GEAR - **G** Separately Switchable, **L** DALI, **D** 1-10V, **H** Touch-Dim, **C** Casambi  
 COLOUR REND. - **8** CRI>80, **9** CRI>90, **F** Full Spectrum  
 COLOUR TEMP. - **22** 2200K, **27** 2700K, **30** 3000K, **35** 3500K, **40** 4000K, **65** 6500K, **TW** Tunable White 2700-6500K  
 POWER - **M** Medium Power, **H** High Power  
 SIZE - Luminaire length in mm: **L894**, **L1182**, **L1475**  
 ON REQUEST - Emergency Module

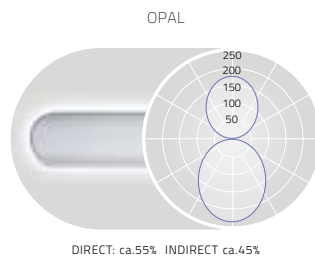
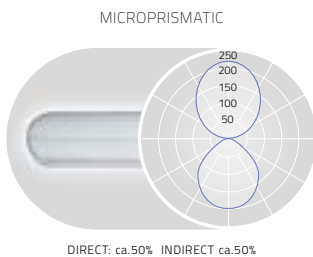

L mm	Lumen/Watt Medium Power	Lumen/Watt High Power
894	3260lm/36W	4580lm/53W
1182	4410lm/46W	6200lm/68W
1475	5560lm/57W	7830lm/83W

L mm	Lumen/Watt Medium Power	Lumen/Watt High Power
894	3910lm/36W	5520lm/53W
1182	5280lm/46W	7460lm/68W
1475	6650lm/57W	9400lm/83W

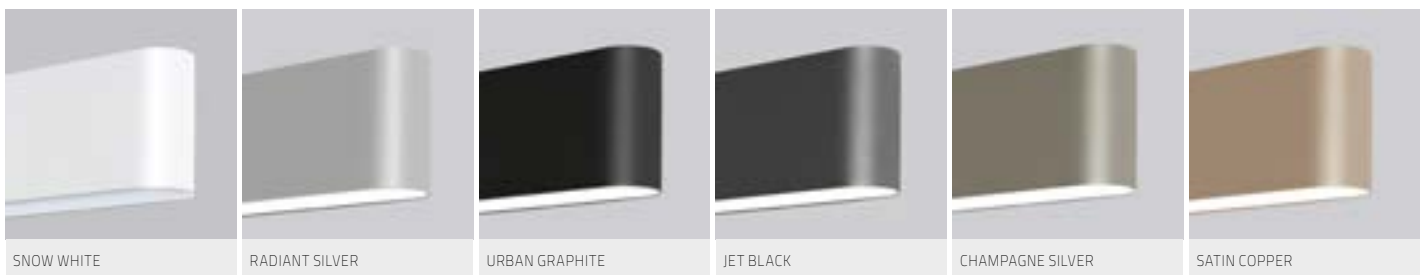



# CUBIC EVOLUTION WALL | W4



**DE** LED-Wand-Anbauleuchte. Direkt-indirektstrahlend. Leuchtenkörper in minimalistischer Bauhöhe aus Aluminiumprofil. Oberfläche naturelxiert oder weiß, graphit, schwarz bzw. champagnerfarben lackiert sowie Alu poliert. Weitere Oberflächenoptionen siehe Lightnet-Surface-Collection oder RAL nach Wahl. Microprismenoptik mit optimierter Blendungsbegrenzung speziell für Office-Anwendungen. Satinierter Opaldiffusor für Allgemeinbeleuchtung mit max. Transmissionsgrad und homogener Lichtpunktauflösung. Indirektanteil mit innovativer Linsentechnologie für breitstrahlende Deckenaufhellung. Konverter in Leuchtengehäuse integriert, wahlweise einfach schaltbar oder stufenlos dimmbar (DALI, TD). Farbtemperaturen 2700K, 3000K, 3500K oder 4000K. Binning initial  $\leq$  MacAdam 3. Farbwiedergabe CRI>80 oder CRI>90. Durchdachtes Montagesystem für einfache Installation und stabilen Halt.

**EN** LED wall mounted luminaire. Direct-indirect light distribution. Luminaire body with minimalistic overall height made of aluminium profile. Surface natural anodised or white, graphite, black or champagne coated as well as polished aluminium. Further surface options see Lightnet-Surface-Collection or RAL of your choice. Microprismatic with optimized glare reduction especially for workplaces. Satin opal diffuser for general lighting with maximum transmittance and homogeneous lighting. Indirect light with innovative lens technology for wide-angle ceiling illumination. Converter integrated into luminaire housing, optionally switchable or dimmable (DALI, TD). Colour temperature 2700K, 3000K, 3500K or 4000K. Binning initial  $\leq$  MacAdam 3. Colour rendering CRI>80 or CRI>90. Sophisticated mounting system for easy installation and stable hold.

**FR** Applique murale LED. Éclairage direct/indirect. Corps du luminaire en profilé aluminium et épaisseur minimaliste. Surface anodisée ou laquée blanc, graphite, noir, champagne ou polie. Autres options de finition voir Lightnet-Surface-Collection ou RAL au choix. Diffuseur microprismatique optimisé pour un éblouissement limité et adapté aux bureaux. Diffuseur opale satiné pour un éclairage général et une transmission maximale et homogène. Composants indirects avec une technologie de lentille innovante pour un éclairage grand angle du plafond. Driver intégré dans le luminaire, au choix ON/OFF ou graduable (DALI, TD). Température de couleur 2700K, 3000K, 3500K ou 4000K. Binning initial  $\leq$  MacAdam 3. Rendu de couleur CRI>80 ou CRI>90. Système de montage sophistiqué pour une installation facile et stable.

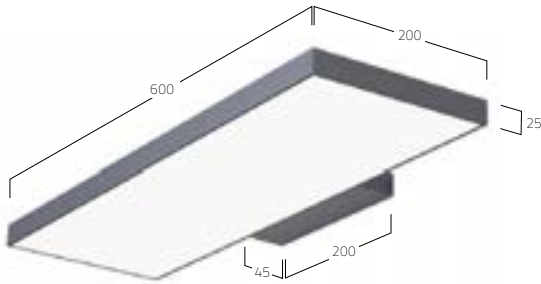

**PRODUCT-CODE:** C W4 A B E - 8 30 M - L600

PRODUCT FAMILY	- C: Cubic
TYPE	- W4: Wall mounted Direct-Indirect
OPTICAL SYSTEM	- A: Microprismatic, O: Opal Diffuser
SURFACE FINISH	- W: Snow White, E: Silver Anodised, U: Urban Graphite, B: Jet Black, H: Champagne Silver, P: Polished Aluminium
CONTROL GEAR	- E: On/Off, L: DALI, H: Touch Dim
COLOUR REND.	- 8: CRI>80, 9: CRI>90
COLOUR TEMP.	- 27: 2700K, 30: 3000K, 35: 3500K, 40: 4000K
POWER	- M: Medium Power
SIZE	- Luminaire Length in mm: L600



**MICROPRISMATIC | DIRECT-INDIRECT**

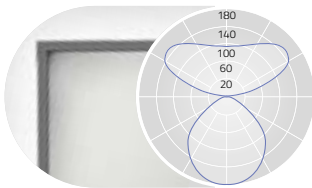

DIRECT: ca.40% INDIRECT ca.60%

L mm	Lumen/Watt Medium Power
600	6630lm/57W

**OPAL DIFFUSER | DIRECT-INDIRECT**

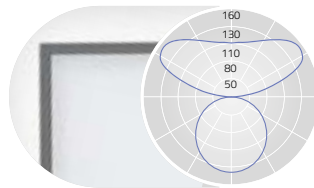

DIRECT: ca.40% INDIRECT ca.60%

L mm	Lumen/Watt Medium Power
600	6650lm/57W

Lumen Values: Luminaire luminous flux at 4000K/CRI>80. Other configurations on request.



# CUBIC EVOLUTION WALL | J4



**DE** LED-Wand-Anbauleuchte. Rein indirektstrahlend. Leuchtenkörper in minimalistischer Bauhöhe aus Aluminiumprofil. Oberfläche natureloxiert oder weiß, graphit, schwarz bzw. champagnerfarben lackiert sowie Alu poliert. Weitere Oberflächenoptionen siehe Lightnet-Surface-Collection oder RAL nach Wahl. Indirektanteil mit innovativer Linsentechnologie für breitstrahlende Deckenaufhellung. Konverter in Leuchtengehäuse integriert, wahlweise einfach schaltbar oder stufenlos dimmbar (DALI, TD). Farbtemperaturen 2700K, 3000K, 3500K oder 4000K. Binning initial ≤ MacAdam 3. Farbwiedergabe CRI>80 oder CRI>90. Durchdachtes Montagesystem für einfache Installation und stabilen Halt.

**EN** LED wall mounted luminaire. Indirect only light distribution. Luminaire body with minimalistic overall height made of aluminium profile. Surface natural anodised or white, graphite, black or champagne coated as well as polished aluminium. Further surface options see Lightnet-Surface-Collection or RAL of your choice. Indirect light with innovative lens technology for wide-angle ceiling illumination. Converter integrated into luminaire housing, optionally switchable or dimmable (DALI, TD). Colour temperature 2700K, 3000K, 3500K or 4000K. Binning initial ≤ MacAdam 3. Colour rendering CRI>80 or CRI>90. Sophisticated mounting system for easy installation and stable hold.

**FR** Applique murale LED. Éclairage seulement indirect. Corps du luminaire en profilé aluminium et épaisseur minimaliste. Surface anodisée ou laquée blanc, graphite, noir, champagne ou polie. Autres options de finition voir Lightnet-Surface-Collection ou RAL au choix. Composants indirects avec une technologie de lentille innovante pour un éclairage grand angle du plafond. Driver intégré dans le luminaire, au choix ON/OFF ou graduable (DALI, TD). Température de couleur 2700K, 3000K, 3500K ou 4000K. Binning initial ≤ MacAdam 3. Rendu de couleur CRI>80 ou CRI>90. Système de montage sophistiqué pour une installation facile et stable.

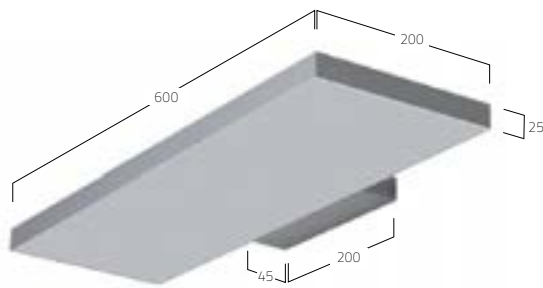

**PRODUCT-CODE: C J4 U B E - 8 30 M - L600**

PRODUCT FAMILY	- C: Cubic
TYPE	- J4: Wall mounted Indirect
OPTICAL SYSTEM	- U: Indirect Optic
SURFACE FINISH	- W: Snow White, E: Silver Anodised, U: Urban Graphite, B: Jet Black, H: Champagne Silver, P: Polished Aluminium
CONTROL GEAR	- E: On/Off, L: DALI, H: Touch Dim
COLOUR REND.	- 8: CRI>80, 9: CRI>90
COLOUR TEMP.	- 27: 2700K, 30: 3000K, 35: 3500K, 40: 4000K
POWER	- M: Medium Power
SIZE	- Luminaire Length in mm: L600



**INDIRECT OPTIC**

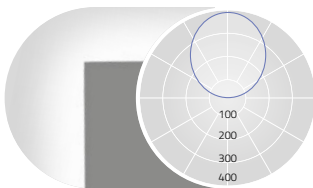

INDIRECT 100%

L mm	Lumen/Watt Medium Power
600	3680lm/28W

Lumen Values: Luminaire luminous flux at 4000K/CRI>80. Other configurations on request.



CUBIC EVOLUTION  
WALL | Y6/X6



**DE** LED-Anbauleuchte für Wand- oder Deckenmontage. Direktstrahlend mit indirekter Lichtkorona oder rein direktstrahlend. Leuchtenkörper in minimalistischer Bauhöhe aus Aluminiumprofil. Oberfläche natureloxiert oder weiß, graphit, schwarz bzw. champagnerfarben lackiert sowie Alu poliert. Weitere Oberflächenoptionen siehe Lightnet-Surface-Collection oder RAL nach Wahl. Indirektanteil mit innovativer Linsentechnologie für breitstrahlende Deckenaufhellung. Konverter in Leuchtengehäuse integriert, wahlweise einfach schaltbar oder stufenlos dimmbar (1-10V, DALI, Touch-Dim, Casambi). Farbtemperaturen 2700K, 3000K, 3500K oder 4000K. Colour temperature 2700K, 3000K, 3500K or 4000K. Binning initial  $\leq$  MacAdam 3. Farbwiedergabe CRI>80 oder CRI>90. Durchdachtes Montagesystem für einfache Installation und stabilen Halt. Auf Anfrage: Integration von Notlichtkomponenten.

**EN** LED surface-mounted luminaire for walls or ceilings. Direct light distribution and indirect lighting corona or direct only light distribution. Luminaire body with minimalistic overall height made of aluminium profile. Surface natural anodised or white, graphite, black or champagne coated as well as polished aluminium. Further surface options see Lightnet-Surface-Collection or RAL of your choice. Indirect light with innovative lens technology for wide-angle ceiling illumination. Converter integrated into luminaire housing, optionally switchable or dimmable (1-10V, DALI, Touch-Dim, Casambi). Colour temperature 2700K, 3000K, 3500K or 4000K. Binning initial  $\leq$  MacAdam 3. Colour rendering CRI>80 or CRI>90. Sophisticated mounting system for easy installation and stable hold. On request: Integration of emergency lighting components.

**FR** Luminaire LED en saillie pour murs et plafonds. Éclairage direct avec colerette de lumière indirecte ou uniquement éclairage direct. Corps du luminaire en profilé aluminium et épaisseur minimaliste. Surface anodisée ou laquée blanc, graphite, noir, champagne ou polie. Autres options de finition voir Lightnet-Surface-Collection ou RAL au choix. Composants indirects avec une technologie de lentille innovante pour un éclairage grand angle du plafond. Driver intégré dans le luminaire, au choix ON/OFF ou graduable (1-10V, DALI, Touch-Dim, Casambi). Température de couleur 2700K, 3000K, 3500K ou 4000K. Binning initial  $\leq$  MacAdam 3. Rendu de couleur CRI>80 ou CRI>90. Système de montage sophistiqué pour une installation facile et stable. Sur demande: Intégration de composants d'éclairage de secours

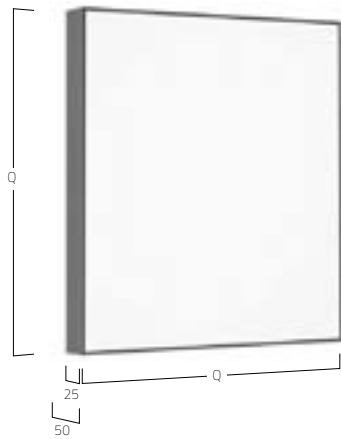

**PRODUCT-CODE: C X6 A B E - 8 30 M - Q600**

- PRODUCT FAMILY – C: Cubic
- TYPE – X6: Square Direct-Indirect, Y6: Square Direct Only
- OPTICAL SYSTEM – A: Microprismatic, O: Opal Diffuser
- SURFACE FINISH – W: Snow White, E: Silver Anodised, U: Urban Graphite, B: Jet Black, H: Champagne Silver, P: Polished Aluminium
- CONTROL GEAR – E: On/Off, L: DALI, D: 1-10V, H: Touch-Dim, C: Casambi
- COLOUR REND. – 8: CRI>80, 9: CRI>90
- COLOUR TEMP. – 27: 2700K, 30: 3000K, 35: 3500K, 40: 4000K, TW: Tunable White 2700-6500K [Q400-Q600]
- POWER – M: Medium Power, H: High Power
- SIZE – Luminaire Length in mm Q300, Q400, Q500, Q600
- ON REQUEST – Emergency Module



MICROPRISMATIC   DIRECT-INDIRECT			MICROPRISMATIC   DIRECT			OPAL DIFFUSER   DIRECT-INDIRECT			OPAL DIFFUSER   DIRECT		
<p>UGR<math>\leq</math>19 (X=4H, Y=8H, S=0.25H) DIRECT: ca.60% INDIRECT ca.40%</p>			<p>UGR<math>\leq</math>19 for Medium Power (X=4H, Y=8H, S=0.25H) DIRECT: 100%</p>			<p>DIRECT: ca.70% INDIRECT ca.30%</p>			<p>DIRECT 100%</p>		
L mm	Lumen/Watt Medium Power	Lumen/Watt High Power	L mm	Lumen/Watt Medium Power	Lumen/Watt High Power	L mm	Lumen/Watt Medium Power	Lumen/Watt High Power	L mm	Lumen/Watt Medium Power	Lumen/Watt High Power
300	1600lm/13W	2360lm/20W	300	1250lm/11W	1820lm/16W	300	1560lm/13W	2300lm/20W	300	1210lm/11W	1760lm/16W
400	2590lm/19W	3570lm/27W	400	2150lm/16W	2950lm/24W	400	2560lm/19W	3530lm/27W	400	2120lm/16W	2910lm/24W
500	4490lm/33W	5860lm/44W	500	3330lm/26W	4350lm/34W	500	4450lm/33W	5800lm/44W	500	3290lm/26W	4290lm/34W
600	6670lm/46W	9240lm/66W	600	4810lm/35W	6630lm/50W	600	6610lm/46W	9110lm/66W	600	4750lm/35W	6500lm/50W

Lumen Values: Luminaire luminous flux at 4000K/CRI>80. Other configurations on request.

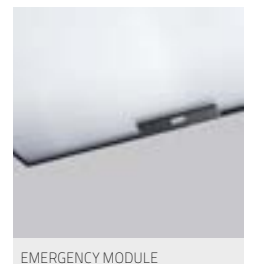

# CUBIC AMBIENT WALL | A7



**DE** LED- Anbauleuchte. Direkt-rundumstrahlend für dezente Deckenaufhellung. Leuchtenkörper aus Aluminium. Oberfläche natureloxiert oder weiß, graphit, schwarz bzw. champagnerfarben lackiert. Weitere Oberflächenoptionen siehe Lightnet-Surface-Collection oder RAL nach Wahl. Ambientdiffusor aus satiniertem Acrylglas für Allgemeinbeleuchtung. Konverter in Leuchtengehäuse integriert, wahlweise einfach schaltbar oder stufenlos dimmbar (1-10V, DALI, Touch-Dim, Casambi). Farbtemperaturen 2700K, 3000K, 3500K oder 4000K. Binning initial ≤ MacAdam 3. Farbwiedergabe CRI>80 oder CRI>90. Auf Anfrage: Integration von Notlichtkomponenten, Sensortechnologie.

**EN** LED surface-mounted luminaire. Omnidirectional light distribution for discreet illumination of the ceiling. Luminaire body made of aluminium. Surface natural anodised or white, graphite, black or champagne coated. Further surface options see Lightnet-Surface-Collection or RAL of your choice. Ambient diffuser made of frosted acrylic glass for general lighting. Driver integrated into luminaire housing, optionally switchable or dimmable (1-10V, DALI, Touch-Dim, Casambi). Colour temperature 2700K, 3000K, 3500K or 4000K. Binning initial ≤ MacAdam 3. Colour rendering CRI>80 or CRI>90. On request: Integration of emergency lighting components, sensor technology.

**FR** Luminaire LED en saillie. Cadre de montage périphérique avec une hauteur totale visible de seulement 18 mm. Corps du luminaire en aluminium. Surface anodisée ou laquée blanc, graphite, noir ou champagne. Autres options de finition voir Lightnet-Surface-Collection ou RAL au choix. Diffuseur AMBIENT en verre satiné acrylique pour diverses applications d'éclairage. Driver intégré dans le luminaire, au choix ON/OFF ou graduable (1-10V, DALI, Touch-Dim, Casambi). Température de couleur 2700K, 3000K, 3500K ou 4000K. Binning initial ≤ MacAdam 3. Rendu de couleur CRI>80 ou CRI>90. Sur demande: Intégration de composants d'éclairage de secours ou de capteurs.

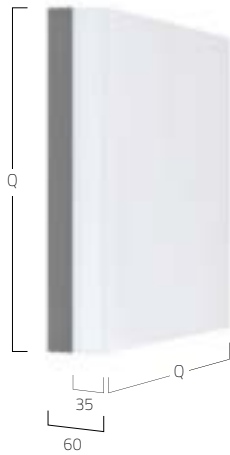

PRODUCT-CODE:		C	A7	F	B	E	-	8	30	M	-	Q300
PRODUCT FAMILY	- C: Cubic											
TYPE	- A7: Surface Direct Only											
OPTICAL SYSTEM	- F: Ambient											
SURFACE FINISH	- W: Snow White, S: Radiant Silver, U: Urban Graphite, B: Jet Black, H: Champagne Silver											
CONTROL GEAR	- E: On/Off, L: DALI, D: 1-10V, H: Touch-Dim, C: Casambi											
COLOUR REND.	- 8: CRI>80, 9: CRI>90, F: Full Spectrum											
COLOUR TEMP.	- 27: 2700K, 30: 3000K, 35: 3500K, 40: 4000K											
POWER	- M: Medium Power, H: High Power											
SIZE	- Square Size in mm: Q300, Q400, Q500, Q600											
ON REQUEST	- Emergency Module											



AMBIENT DIFFUSER | DIRECT

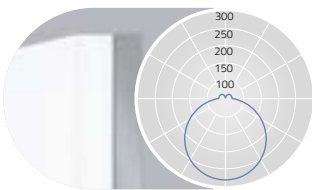

DIRECT: ca.98% INDIRECT: ca.2%

Q mm	Lumen/Watt Medium Power	Lumen/Watt High Power
300	1460lm/12W	2150lm/18W
400	2510lm/20W	3660lm/29W
500	3810lm/27W	7130lm/51W
600	5410lm/40W	8850lm/65W

Lumen Values: Luminaire luminous flux at 4000K/CRI>80. Other configurations on request.

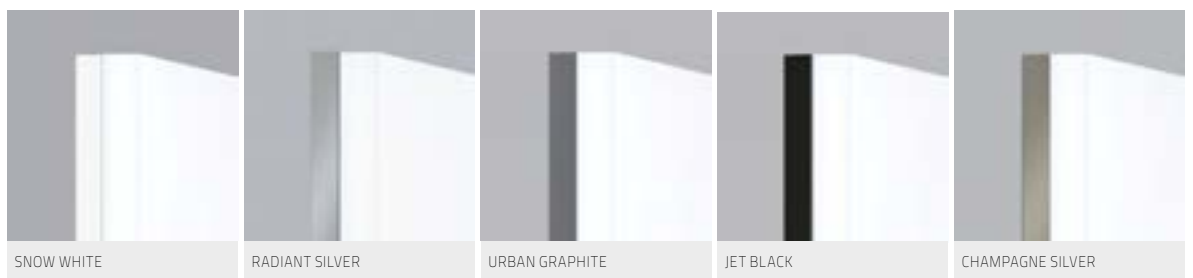



MATRIC 38<sub>MM</sub>  
WALL DIRECT-INDIRECT | W1



**DE** LED-Wand-Anbauleuchte. Direkt-indirektstrahlend. Lichtkanal aus Aluminiumprofil mit 38mm Lichtspur-Breite. Millimetergenaue Längenfertigung nach Vorgabe möglich. Oberfläche naturelxiert oder weiß, graphit, schwarz, champagner oder kupferfarben lackiert. Weitere Oberflächenoptionen siehe Lightnet-Surface-Collection oder RAL nach Wahl. Opaldiffusor aus satiniertem Acrylglas für Allgemeinbeleuchtung. Konverter in Leuchtgehäuse integriert, wahlweise einfach schaltbar oder stufenlos dimmbar (1-10V, DALI, Touch-Dim, Casambi). Farbtemperaturen 2200K, 2700K, 3000K, 3500K, 4000K oder 6500K. Binning initial ≤ MacAdam 3. Farbwiedergabe a>80 oder CRI>90. Auf Anfrage: Integration von Notlichtkomponenten.

**EN** LED wall mounted luminaire. Direct-indirect light distribution. Light channel made of aluminium profile with 38mm track width. Precise length production according to specifications possible. Surface natural anodised or white, graphite, black, champagne or copper coated. Further surface options see Lightnet-Surface-Collection or RAL of your choice. Opal diffuser made of acrylic glass for general lighting. Converter integrated into luminaire housing, optionally switchable or dimmable (1-10V, DALI, Touch-Dim, Casambi). Colour temperatures 2200K, 2700K, 3000K, 3500K, 4000K or 6500K. Binning initial ≤ MacAdam 3. Colour rendering CRI>80 or CRI>90. On request: Integration of emergency lighting components.

**FR** Applique murale LED. Éclairage direct/indirect. Rail lumineux en profilé d'aluminium avec une largeur d'éclairage de 38 mm. Fabrication au millimètre près des longueurs selon les spécifications. Surface anodisée ou laquée blanc, graphite, noir, champagne ou cuivre. Autres options de finition voir Lightnet-Surface-Collection ou RAL au choix. Diffuseur opale en verre acrylique pour éclairage général. Driver intégré dans le luminaire, au choix ON/OFF ou graduable (1-10V, DALI, Touch-Dim, Casambi). Température de couleur 2200K, 2700K, 3000K, 3500K, 4000K ou 6500K. Binning initial ≤ MacAdam 3. Rendu de couleur CRI>80 ou CRI>90. Sur demande: Intégration de composants d'éclairage de secours.

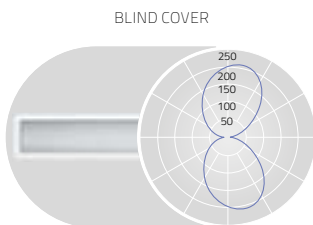
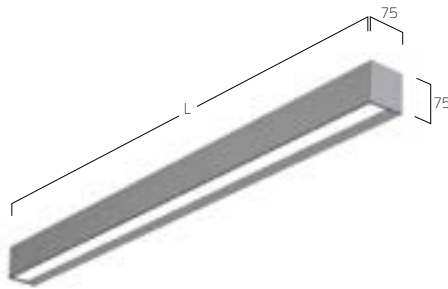

DIRECT: ca.50% INDIRECT ca.50%

L mm	Lumen/Watt Medium Power	Lumen/Watt High Power
600	2130lm/20W	2920lm/27W
895	3200lm/28W	4380lm/39W
1185	4260lm/35W	5840lm/50W
1478	5320lm/44W	7300lm/63W
1770	6390lm/52W	8760lm/75W
2060	7450lm/61W	10220lm/88W

Lumen Values: Luminaire luminous flux at 4000K/CRI>80. Other configurations on request.

**PRODUCT-CODE:** L W1B E E - 8 30 M - L1185

- PRODUCT FAMILY – L: Matrix
- TYPE – W1: Wall mounted - Direct-Indirect
- OPTICAL SYSTEM – B: Blind Cover
- SURFACE FINISH – W: Snow White, E: Silver Anodised, U: Urban Graphite, B: Jet Black, H: Champagne Silver, K: Satin Copper, P: Polished Aluminum
- CONTROL GEAR – E: On/Off, L: DALI, D: 1-10V, H: Touch-Dim, A: Casambi Micro
- COLOUR REND. – 8: CRI>80, 9: CRI>90, F: Full Spectrum
- COLOUR TEMP. – 22: 2200K, 27: 2700K, 30: 3000K, 35: 3500K, 40: 4000K, 65: 6500K, TW: Tunable White 2700-6500K [L1185-L2060]
- POWER – M: Medium Power, H: High Power
- SIZE – Luminaire length in mm: L600, L895, L1185, L1478, L1770, L2060
- ON REQUEST – Emergency Module, 90°-Corner, Laser Cut



MATRIC 38 MM  
WALL DIRECT | D2



**DE** LED-Wand-Anbauleuchte. Rein Direktstrahlend. Lichtkanal aus Aluminiumprofil mit 38mm Lichtspur-Breite. Millimetergenaue Längenfertigung nach Vorgabe möglich. Oberfläche natureloxiert oder weiß, graphit, schwarz, champagner oder kupferfarben lackiert. Weitere Oberflächenoptionen siehe Lightnet-Surface-Collection oder RAL nach Wahl. Microprismenoptik mit optimierter Blendungsbegrenzung speziell für Office-Anwendungen. Satinierter Opaldiffusor für Allgemeinbeleuchtung. Konverter in Leuchtgehäuse integriert, wahlweise einfach schaltbar oder stufenlos dimmbar (1-10V, DALI, Touch-Dim, Casambi). Farbtemperaturen 2200K, 2700K, 3000K, 3500K, 4000K oder 6500K. Binning initial  $\leq$  MacAdam 3. Farbwiedergabe CRI>80 oder CRI>90. Auf Anfrage: Integration von Notlichtkomponenten.

**EN** LED wall mounted luminaire. Direct only light distribution. Light channel made of aluminium profile with 38mm profile width. Precise length production according to specifications possible. Surface natural anodised or white, graphite, black, champagne or copper coated. Further surface options see Lightnet-Surface-Collection or RAL of your choice. Microprismatic with optimized glare reduction especially for workplaces. Satin opal diffuser for general lighting. Driver integrated into luminaire housing, optionally switchable or dimmable (1-10V, DALI, Touch-Dim, Casambi). Colour temperatures 2200K, 2700K, 3000K, 3500K, 4000K or 6500K. Binning initial  $\leq$  MacAdam 3. Colour rendering CRI>80 or CRI>90. On request: Integration of emergency lighting components.

**FR** Applique murale LED. Éclairage seulement direct. Rail lumineux en profilé d'aluminium avec une largeur d'éclairage de 38 mm. Fabrication au millimètre près des longueurs selon les spécifications. Surface anodisée ou laquée blanc, graphite, noir, champagne ou cuivre. Autres options de finition voir Lightnet-Surface-Collection ou RAL au choix. Diffuseur microprismatique optimisé pour un éblouissement limité et adapté aux bureaux. Diffuseur opale satinée pour un éclairage général. Driver intégré dans le luminaire, au choix ON/OFF ou graduable (1-10V, DALI, Touch-Dim, Casambi). Température de couleur 2200K, 2700K, 3000K, 3500K, 4000K ou 6500K. Binning initial  $\leq$  MacAdam 3. Rendu de couleur CRI>80 ou CRI>90. Sur demande: Intégration de composants d'éclairage de secours.

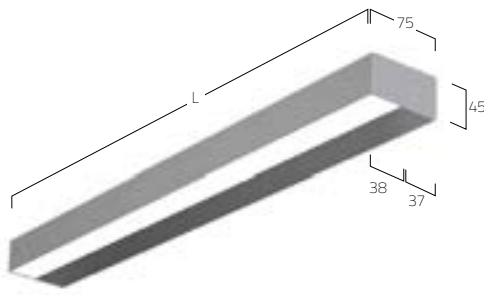

**PRODUCT-CODE:** L D2 O E E - 8 30 M - L1182

PRODUCT FAMILY	- L: Matric
TYPE	- D2: Wall mounted - Direct
OPTICAL SYSTEM	- O: Opal, A: Microprismatic
SURFACE FINISH	- W: Snow White, E: Silver Anodised, U: Urban Graphite, B: Jet Black, H: Champagne Silver, K: Satin Copper
CONTROL GEAR	- E: On/Off, L: DALI, D: 1-10V, H: Touch-Dim, C: Casambi
COLOUR REND.	- 8: CRI>80, 9: CRI>90, F: Full Spectrum
COLOUR TEMP.	- 22: 2200K, 27: 2700K, 30: 3000K, 35: 3500K, 40: 4000K, 65: 6500K, TW: Tunable White 2700-6500K
POWER	- M: Medium Power, H: High Power
SIZE	- Luminaire length in mm: L890, L1182, L1475, L1765, L2055
ON REQUEST	- Emergency Module



MICROPRISMATIC | DIRECT

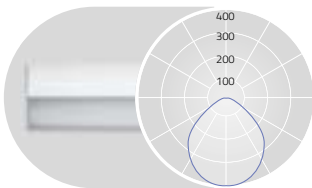

DIRECT: 100%

OPAL DIFFUSER | DIRECT

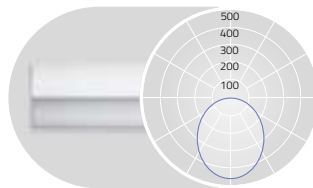

DIRECT: 100%

L mm	Lumenlm/Watt Medium Power	Lumenlm/Watt High Power
890	710lm/16W	980lm/21W
1182	950lm/20W	1300lm/27W
1475	1190lm/24W	1630lm/33W
1765	1420lm/28W	1950lm/39W
2055	1660lm/31W	2280lm/44W

L mm	Lumenlm/Watt Medium Power	Lumenlm/Watt High Power
890	1120lm/16W	1540lm/21W
1182	1500lm/20W	2050lm/27W
1475	1870lm/24W	2560lm/33W
1765	2240lm/28W	3080lm/39W
2055	2620lm/31W	3590lm/44W



MATRIC 38 MM  
WALL INDIRECT | J1



**DE** LED-Wand-Anbauleuchte. Rein indirektstrahlend. Lichtkanal aus Aluminiumprofil. Millimetergenaue Längenfertigung nach Vorgabe möglich. Oberfläche naturreloxiert oder weiß, graphit, schwarz, champagner oder kupferfarben lackiert. Weitere Oberflächenoptionen siehe Lightnet-Surface-Collection oder RAL nach Wahl. Konverter in Leuchtgehäuse integriert, wahlweise einfach schaltbar oder stufenlos dimmbar (1-10V, DALI, Touch-Dim, Casambi). Farbtemperaturen 2200K, 2700K, 3000K, 3500K, 4000K oder 6500K. Binning initial  $\leq$  MacAdam 3. Farbwiedergabe CRI>80 oder CRI>90. Versand am Stück bis L:2055mm, auf Nachfrage bis L:2930mm möglich.

**EN** LED wall mounted luminaire. Indirect only light distribution. Light channel made of aluminium profile. Precise length production according to specifications possible. Surface natural anodised or white, graphite, black, champagne or copper coated. Further surface options see Lightnet-Surface-Collection or RAL of your choice. Driver integrated into luminaire housing, optionally switchable or dimmable (1-10V, DALI, Touch-Dim, Casambi). Colour temperatures 2200K, 2700K, 3000K, 3500K, 4000K or 6500K. Binning initial  $\leq$  MacAdam 3. Colour rendering CRI>80 or CRI>90. Shipping in one piece up to L: 2055mm, on request up to L: 2930mm possible.

**FR** Applique murale LED. Éclairage seulement indirect. Rail lumineux en profilé d'aluminium. Fabrication au millimètre près des longueurs selon les spécifications. Surface anodisée ou laquée blanc, graphite, noir, champagne ou cuivre. Autres options de finition voir Lightnet-Surface-Collection ou RAL au choix. Driver intégré dans le luminaire, au choix ON/OFF ou graduable (1-10V, DALI, Touch-Dim, Casambi). Température de couleur 2200K, 2700K, 3000K, 3500K, 4000K ou 6500K. Binning initial  $\leq$  MacAdam 3. Rendu de couleur CRI>80 ou CRI>90. Livraison en une seule pièce jusqu'à L: 2055mm, sur demande jusqu'à L: 2930mm possible.

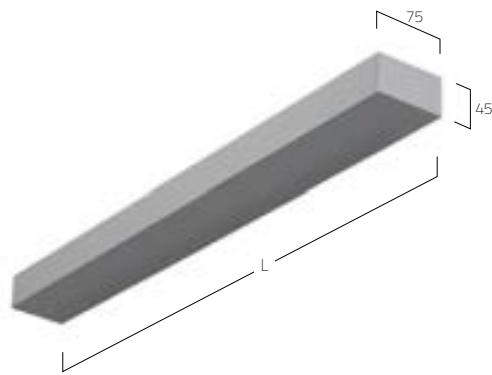

**PRODUCT-CODE:** L J1 A E E - 8 30 M - L1182

PRODUCT FAMILY	- L: Matric
TYPE	- J1: Wall mounted - Indirect
OPTICAL SYSTEM	- A: Microprismatic
SURFACE FINISH	- W: Snow White, E: Silver Anodised, U: Urban Graphite, B: Jet Black, H: Champagne Silver, K: Satin Copper
CONTROL GEAR	- E: On/Off, L: DALI, D: 1-10V, H: Touch-Dim, C: Casambi
COLOUR REND.	- 8: CRI>80, 9: CRI>90, F: Full Spectrum
COLOUR TEMP.	- 22: 2200K, 27: 2700K, 30: 3000K, 35: 3500K, 40: 4000K, 65: 6500K, TW: Tunable White 2700-6500K
POWER	- M: Medium Power, H: High Power
SIZE	- Luminaire length in mm: L890, L1182, L1475, L1765, L2055



MICROPRISMATIC | INDIRECT

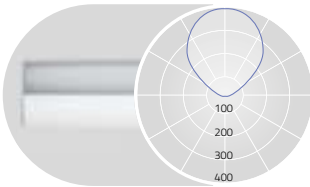

INDIRECT: 100%

L mm	Lumenlm/Watt Medium Power	Lumenlm/Watt High Power
890	710lm/16W	980lm/21W
1182	950lm/20W	1300lm/27W
1475	1190lm/24W	1630lm/33W
1765	1420lm/28W	1950lm/39W
2055	1660lm/31W	2280lm/44W

Lumen Values: Luminaire luminous flux at 4000K/CRI>80. Other configurations on request.

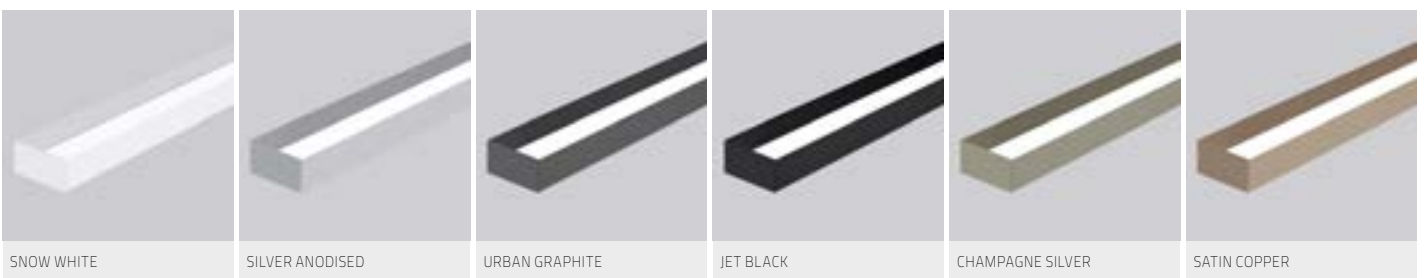

MATRIC 55 MM  
WALL DIRECT | D3



**DE** LED-Wand-Anbauleuchte. Rein Direktstrahlend. Lichtkanal aus Aluminiumprofil mit 55mm Lichtspur-Breite. Millimetergenaue Längenfertigung nach Vorgabe möglich. Oberfläche naturel oxidiert oder weiß, graphit, schwarz, champagner oder kupferfarben lackiert. Weitere Oberflächenoptionen siehe Lightnet-Surface-Collection oder RAL nach Wahl. Microprismenoptik und Satin-Louvier für Office-Anwendungen. Opaldiffusor aus satiniertem Acrylglas für Allgemeinbeleuchtung. Konverter in Leuchtgehäuse integriert, wahlweise einfach schaltbar oder stufenlos dimmbar (1-10V, DALI, Touch-Dim, Casambi). Farbtemperaturen 2200K, 2700K, 3000K, 3500K, 4000K oder 6500K. Binning initial  $\leq$  MacAdam 3. Farbwiedergabe  $a > 80$  oder CRI  $> 90$ . Auf Anfrage: Integration von Notlichtkomponenten, Sensortechnologie.

**EN** LED wall mounted luminaire. Direct only light distribution. Light channel made of aluminium profile with 55mm track width. Precise length production according to specifications possible. Surface natural anodised or white, graphite, black, champagne or copper coated. Further surface options see Lightnet-Surface-Collection or RAL of your choice. Microprismatic and satin louver for office purposes. Opal diffuser made of acrylic glass for general lighting. Converter integrated into luminaire housing, optionally switchable or dimmable (1-10V, DALI, Touch-Dim, Casambi). Colour temperatures 2200K, 2700K, 3000K, 3500K, 4000K or 6500K. Binning initial  $\leq$  MacAdam 3. Colour rendering CRI  $> 80$  or CRI  $> 90$ . On request: Integration of emergency lighting components, sensor technology.

**FR** Applique murale LED. Éclairage seulement direct. Rail lumineux en profilé d'aluminium avec une largeur d'éclairage de 55mm. Fabrication au millimètre près des longueurs selon les spécifications. Surface anodisée ou laquée blanc, graphite, noir, champagne ou cuivre. Autres options de finition voir Lightnet-Surface-Collection ou RAL au choix. Optique microprismatique et satin louver pour postes de travail. Diffuseur opale en verre acrylique pour éclairage général. Driver intégré dans le luminaire, au choix ON/OFF ou graduable (1-10V, DALI, Touch-Dim, Casambi). Température de couleur 2200K, 2700K, 3000K, 3500K, 4000K ou 6500K. Binning initial  $\leq$  MacAdam 3. Rendu de couleur CRI  $> 80$  ou CRI  $> 90$ . Sur demande: Intégration de composants d'éclairage de secours ou de capteurs.

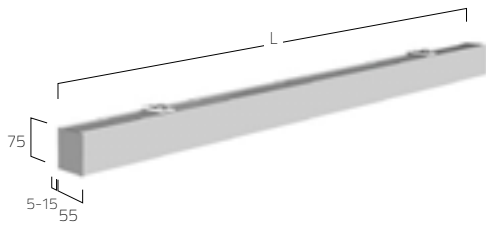

**PRODUCT-CODE:** L D3 A E E - 8 30 M - L890

- PRODUCT FAMILY – L: Matrix
- TYPE – D3: Wall-mounted Direct Only
- OPTICAL SYSTEM – A: Microprismatic, O: Opal, M: Satin Louver,
- SURFACE FINISH – W: Snow White, E: Silver Anodised, U: Urban Graphite, B: Jet Black, H: Champagne Silver, K: Satin Copper
- CONTROL GEAR – E: On/Off, L: DALI, D: 1-10V, H: Touch-Dim
- COLOUR REND. – 8: CRI  $> 80$ , 9: CRI  $> 90$ , F: Full Spectrum
- COLOUR TEMP. – 22: 2200K, 27: 2700K, 30: 3000K, 35: 3500K, 40: 4000K, 65: 6500K, TW: Tunable White 2700-6500K [L890-L2055]
- POWER – E: Low Power, M: Medium Power, H: High Power
- SIZE – Luminaire length in mm: L600, L890, L1182, L1475, L1765, L2055
- ON REQUEST – Special Length Versions, 90°-Elements, Midpin&Midpoint Spotlights/Downlights, Emergency Module, Multisensor, Casambi, 3-Phase Track



MICROPRISMATIC | DIRECT

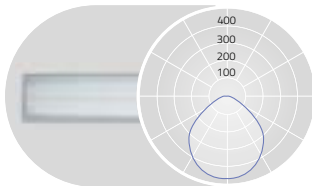

UGR  $\leq 19$  for Low Power (X=4H, Y=8H, S=0.25H) DIRECT 100%

OPAL DIFFUSER | DIRECT

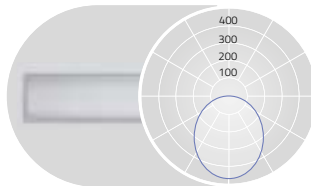

DIRECT 100%

SATIN LOUVER | DIRECT

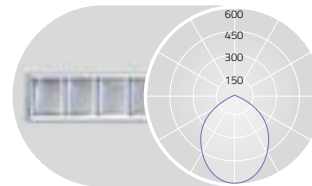

UGR  $\leq 19$  for Medium Power (X=4H, Y=8H, S=0.25H) DIRECT 100%

L mm	Lumen/Watt Low Power	Lumen/Watt Medium Power	Lumen/Watt High Power
600	780lm/8W	1300lm/13W	1890lm/19W
890	1170lm/12W	1950lm/19W	2830lm/28W
1182	1560lm/15W	2600lm/24W	3780lm/36W
1475	1950lm/17W	3250lm/29W	4720lm/44W
1765	2340lm/20W	3900lm/34W	5670lm/52W
2055	2730lm/23W	4550lm/39W	6610lm/58W

L mm	Lumen/Watt Low Power	Lumen/Watt Medium Power	Lumen/Watt High Power
600	830lm/8W	1390lm/13W	2010lm/19W
890	1250lm/12W	2080lm/19W	3020lm/28W
1182	1660lm/15W	2770lm/24W	4030lm/36W
1475	2080lm/17W	3470lm/29W	5040lm/44W
1765	2490lm/20W	4160lm/34W	6040lm/52W
2055	2910lm/23W	4850lm/39W	7050lm/58W

L mm	Lumen/Watt Medium Power	Lumen/Watt High Power
600	940lm/13W	1360lm/19W
890	1400lm/19W	2040lm/28W
1182	1870lm/24W	2720lm/36W
1475	2340lm/29W	3400lm/44W
1765	2810lm/34W	4080lm/52W
2055	3270lm/39W	4760lm/58W

Lumen Values: Luminaire luminous flux at 4000K/CRI  $> 80$ . Other configurations on request.



90° CORNER OPAL DIFFUSER | MICROPRISMATIC



MIDPIN-DOWNLIGHT 770lm / 11W /  $\varnothing 37$ mm

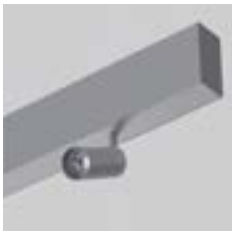

MIDPIN-SINGLE SPOTLIGHT 770lm / 11W /  $\varnothing 37$ mm



3-PHASE TRACK COMPATIBLE WITH GLOBAL-ADAPTORS



MULTISENSOR DAYLIGHT & PRESENCE



SNOW WHITE

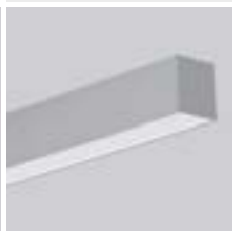

SILVER ANODISED



URBAN GRAPHITE

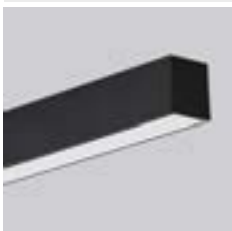

JET BLACK



CHAMPAGNE SILVER



SATIN COPPER



MATRIC 55 MM  
WALL DIRECT-INDIRECT | W4



**DE** LED-Wand-Anbauleuchte. Direkt-indirektstrahlend. Lichtkanal aus Aluminiumprofil mit 55mm Lichtspur-Breite. Millimetergenaue Längenfertigung nach Vorgabe möglich. Oberfläche naturelxiert oder weiß, graphit, schwarz, champagner oder kupferfarben lackiert. Weitere Oberflächenoptionen siehe Lightnet-Surface-Collection oder RAL nach Wahl. Microprismenoptik mit optimierter Blendungsbegrenzung speziell für Office-Anwendungen. Satinierter Opaldiffusor für Allgemeinbeleuchtung. Konverter in Leuchtgehäuse integriert, wahlweise getrennt schaltbar oder dimmbar (1-10V, DALI, Touch-Dim, Casambi). Farbtemperaturen 2200K, 2700K, 3000K, 3500K, 4000K oder 6500K. Binning initial  $\leq$  MacAdam 3. Colour rendering CRI>80 oder CRI>90. Auf Anfrage: Integration von Notlichtkomponenten.

**EN** LED wall mounted luminaire. Direct-indirect light distribution. Light channel made of aluminium profile with 55mm profile width. Precise length production according to specifications possible. Surface natural anodised or white, graphite, black, champagne or copper coated. Further surface options see Lightnet-Surface-Collection or RAL of your choice. Microprismatic with optimized glare reduction especially for workplaces. Satin opal diffuser for general lighting. Driver integrated into luminaire housing, optionally separately switchable or dimmable (1-10V, DALI, Touch-Dim, Casambi). Colour temperatures 2200K, 2700K, 3000K, 3500K, 4000K or 6500K. Binning initial  $\leq$  MacAdam 3. Colour rendering CRI>80 or CRI>90. On request: Integration of emergency lighting components.

**FR** Applique murale LED. Éclairage direct/indirect. Rail lumineux en profilé d'aluminium avec une largeur d'éclairage de 55mm. Fabrication au millimètre près des longueurs selon les spécifications. Surface anodisée ou laquée blanc, graphite, noir, champagne ou cuivre. Autres options de finition voir Lightnet-Surface-Collection ou RAL au choix. Diffuseur microprismatique optimisé pour un éblouissement limité et adapté aux bureaux. Diffuseur opale satinée pour un éclairage général. Convertisseur intégré dans le boîtier du luminaire, au choix 2 allumages séparés ou dimmable (1-10V, DALI, Touch-Dim, Casambi). Température de couleur 2200K, 2700K, 3000K, 3500K, 4000K ou 6500K. Binning initial  $\leq$  MacAdam 3. Rendu de couleur CRI>80 ou CRI>90. Sur demande: Intégration de composants d'éclairage de secours

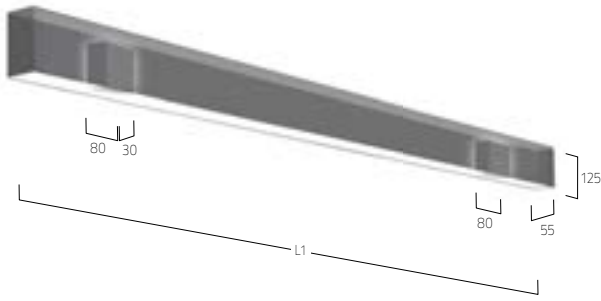

**PRODUCT-CODE:** L W4 O E G - 8 30 M - L1182

PRODUCT FAMILY	- L: Matric
TYPE	- W4: Wall mounted - Direct-Indirect
OPTICAL SYSTEM	- O: Opal, A: Microprismatic, M: Satin Louver, G: Wallwasher
SURFACE FINISH	- W: Snow White, E: Silver Anodised, U: Urban Graphite, B: Jet Black, H: Champagne Silver, K: Satin Copper
CONTROL GEAR	- G: Separately Switchable, L: Dali, D: 1-10V, H: Touch-Dim, C: Casambi
COLOUR REND.	- 8: CRI>80, 9: CRI>90, F: Full Spectrum
COLOUR TEMP.	- 22: 2200K, 27: 2700K, 30: 3000K, 35: 3500K, 40: 4000K, 65: 6500K, TW: Tunable White 2700-6500K
POWER	- E: Low Power, M: Medium Power, H: High Power
SIZE	- Luminaire length in mm: L890, L1182, L1475, L1765, L2055
ON REQUEST	- Special Length Versions, 90°-Elements, 90°-Corner, 3-Phase Track, Midpin&Midpoint Spotlights/Downlights, Emergency Module, Multisensor



MICROPRISMATIC | DIRECT-INDIRECT

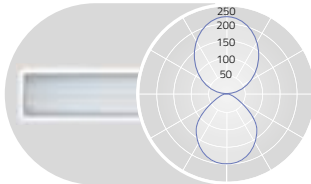

UGR $\leq$ 19 for Low Power (X=4H, Y=8H, S=0.25H)  
DIRECT: ca.50% INDIRECT ca.50%

OPAL DIFFUSER | DIRECT-INDIRECT

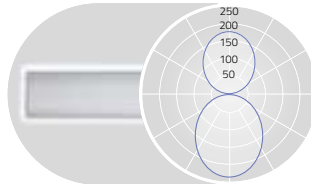

DIRECT: ca.55% INDIRECT ca.45%

SATIN LOUVER | DIRECT-INDIRECT

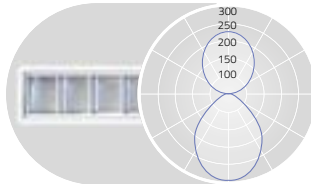

UGR $\leq$ 16 (X=4H, Y=8H, S=0.25H)  
DIRECT: ca.45% INDIRECT ca.55%

WALLWASHER | DIRECT-INDIRECT

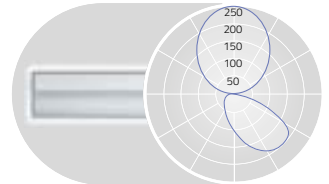

DIRECT: ca.40% INDIRECT ca.60%

L mm	Lumen/Watt Low Power	Lumen/Watt Medium Power	Lumen/Watt High Power
890	2360lm/19W	3620lm/33W	5130lm/47W
1182	3200lm/25W	4900lm/42W	6930lm/61W
1475	4030lm/30W	6180lm/52W	8730lm/75W
1765	4870lm/36W	7450lm/61W	10540lm/89W
2055	5710lm/42W	8730lm/69W	12340lm/100W

L mm	Lumen/Watt Low Power	Lumen/Watt Medium Power	Lumen/Watt High Power
890	2440lm/19W	3750lm/33W	5310lm/47W
1182	3300lm/25W	5070lm/42W	7180lm/61W
1475	4160lm/30W	6390lm/52W	9050lm/75W
1765	5030lm/36W	7710lm/61W	10910lm/89W
2055	5890lm/42W	9030lm/69W	12780lm/100W

L mm	Lumen/Watt Medium Power	Lumen/Watt High Power
890	3080lm/33W	4330lm/47W
1182	4170lm/42W	5870lm/61W
1475	5270lm/52W	7410lm/75W
1765	6360lm/61W	8950lm/89W
2055	7460lm/69W	10490lm/100W

L mm	Lumen/Watt Medium Power	Lumen/Watt High Power
890	2840lm/27W	3900lm/37W
1182	3860lm/34W	5290lm/48W
1475	4880lm/43W	6680lm/61W
1765	5890lm/51W	8080lm/73W
2055	6910lm/60W	9470lm/86W

Lumen Values: Luminaire luminous flux at 4000K/CRI>80. Other configurations on request.



90° CORNER  
OPAL DIFFUSER | MICROPRISMATIC

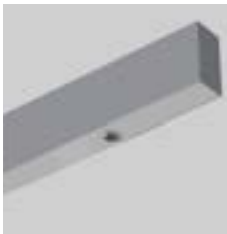

MIDPIN-DOWNLIGHT  
770lm / 11W /  $\varnothing$ 37mm



MIDPIN-SINGLE SPOTLIGHT  
770lm / 11W /  $\varnothing$ 37mm

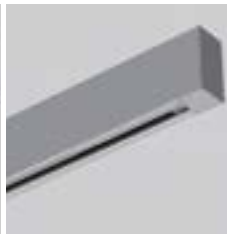

3-PHASE TRACK COMPATIBLE  
WITH GLOBAL-ADAPTORS

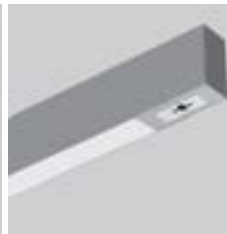

MULTISENSOR  
DAYLIGHT & PRESENCE



SNOW WHITE



SILVER ANODISED



URBAN GRAPHITE



JET BLACK

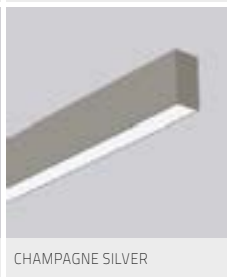

CHAMPAGNE SILVER



SATIN COPPER

MATRIC 81<sub>MM</sub>  
WALL DIRECT-INDIRECT | W5



**DE** LED-Wand-Anbauleuchte. Direkt-indirektstrahlend. Lichtkanal aus Aluminiumprofil mit 81mm Lichtspur-Breite. Oberfläche natureloxiert oder weiß, graphit, schwarz, champagner oder kupferfarben lackiert. Weitere Oberflächenoptionen siehe Lightnet-Surface-Collection oder RAL nach Wahl. Microprismenoptik mit optimierter Blendungsbegrenzung speziell für Office-Anwendungen. Konverter in Leuchtgehäuse integriert, wahlweise einfach schaltbar oder stufenlos dimmbar (1-10V, DALI, Touch-Dim, Casambi). Farbtemperaturen 2200K, 2700K, 3000K, 3500K, 4000K oder 6500K. Binning initial ≤ Mac Adam 3. Farbwiedergabe CRI>80 oder CRI>90.

**EN** LED wall mounted luminaire. Direct-indirect light distribution. Light channel made of aluminium profile with 81mm profile width. Surface natural anodised or white, graphite, black, champagne or copper coated. Further surface options see Lightnet-Surface-Collection or RAL of your choice. Microprismatic with optimized glare reduction especially for workplaces. Satin opal diffuser for general lighting. Driver integrated into luminaire housing, optionally switchable or dimmable (1-10V, DALI, Touch-Dim, Casambi). Colour temperatures 2200K, 2700K, 3000K, 3500K, 4000K or 6500K. Binning initial ≤ MacAdam 3. Colour rendering CRI>80 or CRI>90.

**FR** Applique murale LED. Éclairage direct/indirect. Rail lumineux en profilé d'aluminium avec une largeur d'éclairage de 81mm. Surface anodisée ou laquée blanc, graphite, noir, champagne ou cuivre. Autres options de finition voir Lightnet-Surface-Collection ou RAL au choix. Diffuseur microprismatique optimisé pour un éblouissement limité et adapté aux bureaux. Diffuseur opale satinée pour un éclairage général. Driver intégré dans le luminaire, au choix ON/OFF ou graduable (1-10V, DALI, Touch-Dim, Casambi). Température de couleur 2200K, 2700K, 3000K, 3500K, 4000K ou 6500K. Binning initial ≤ MacAdam 3. Rendu de couleur CRI>80 ou CRI>90.

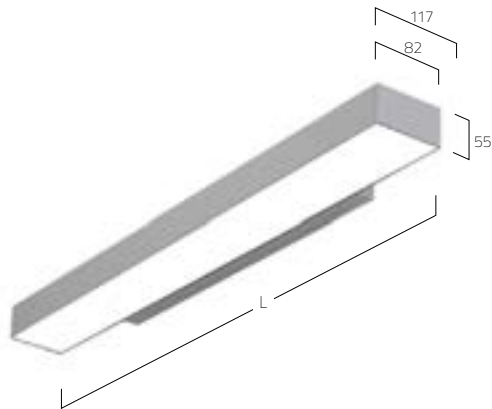

**PRODUCT-CODE:** L W5 O E E - 8 30 M - L1182

PRODUCT FAMILY	- L: Matric
TYPE	- W5: Wall mounted Direct-Indirect
OPTICAL SYSTEM	- O: Opal, A: Microprismatic
SURFACE FINISH	- W: Snow White, E: Silver Anodised, U: Urban Graphite, B: Jet Black, H: Champagne Silver, K: Satin Copper
CONTROL GEAR	- E: On/Off, L: DALI, D: 1-10V, H: Touch-Dim
COLOUR REND.	- 8: CRI>80, 9: CRI>90, F: Full Spectrum
COLOUR TEMP.	- 22: 2200K, 27: 2700K, 30: 3000K, 35: 3500K, 40: 4000K, 65: 6500K, TW: Tunable White 2700-6500K
POWER	- M: Medium Power, H: High Power
SIZE	- Luminaire length in mm: L890, L1182, L1475

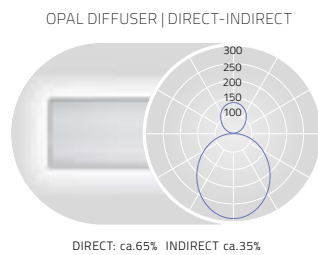
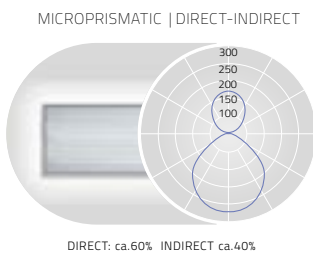

L mm	Lumen/Watt Medium Power	Lumen/Watt High Power
890	3960lm/35W	5350lm/48W
1182	5340lm/45W	7210lm/62W
1475	6720lm/56W	9080lm/76W

L mm	Lumen/Watt Medium Power	Lumen/Watt High Power
890	4210lm/35W	5680lm/48W
1182	5670lm/45W	7650lm/62W
1475	7140lm/56W	9630lm/76W

Lumen Values: Luminaire luminous flux at 4000K/CRI>80. Other configurations on request.





MIDPOINT  
SUSPENDED | P7/P8 150



RINGO STAR + MIDPOINT  
SUSPENDED | G1/P1 152



BASIC SUPERFLAT  
SUSPENDED | G7/P7 158

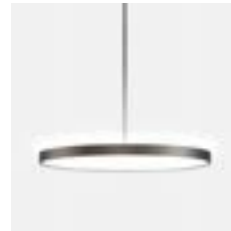

BASIC NEO  
SUSPENDED | G5/P5 160



BASIC DÉCO  
SUSPENDED | G3/P3 162



BEAM ME UP JR  
SUSPENDED | G3/P3 170



BEAM ME UP  
SUSPENDED | G1/P1 176



RINGO STAR 38MM  
SUSPENDED | G6/P6 194



RINGO STAR 60MM  
SUSPENDED | G3/P3 196



RINGO STAR 100MM  
SUSPENDED | G1/P1 198



RINGO STAR READY CHAIN  
SUSPENDED | G3/P3 212



LIQUID LINE LINEAR MODULES  
SUSPENDED | G3/P3 224



LIQUID LINE BEND MODULES  
SUSPENDED | G3/P3 226



LIQUID LINE CURVE MODULES  
SUSPENDED | G3/P3 228



LIQUID LINE WAVE MODULES  
SUSPENDED | G3/P3 230



CODE ZERO  
SUSPENDED | G3/P3 244



THREE PEAKS  
SUSPENDED | G/P 248



CALEO INVERSE  
SUSPENDED | G3/P3 252



CALEO LINEAR  
SUSPENDED | G3/R4 254



CALEO  
SUSPENDED | G1/P1 256



CUBIC EVOLUTION  
SUSPENDED | U4 266



CUBIC EVOLUTION  
SUSPENDED | R4 268

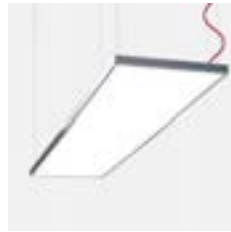

CUBIC EVOLUTION  
SUSPENDED | G5/P5 270



CUBIC EVOLUTION  
SUSPENDED | G6/P6 272



CUBIC EVOLUTION CLUSTER  
SUSPENDED | G6/P6 274



MATRIC 38MM SQUARE  
ACOUSTIC  
SUSPENDED | G1/R1 282



MATRIC 38MM BAFFLE  
SUSPENDED | G1 284

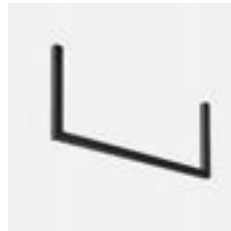

MATRIC 38MM LENS LOUVER  
SUSPENDED | P2 286



MATRIC 38MM WORK ZONE  
SUSPENDED | P1 298



MATRIC 38MM LENS LOUVER  
SUSPENDED DIRECT | G1 300



MATRIC 55MM  
SUSPENDED DIRECT G3 308

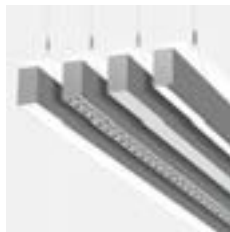

MATRIC 55MM  
SUSPENDED DIRECT-INDIR. | R3 310

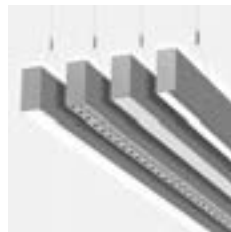

MATRIC 55MM  
SUSPENDED DIRECT-INDIR. | R4 312



MATRIC 81MM  
SUSPENDED DIRECT | G5 314



MATRIC 81MM  
SUSPENDED DIRECT | G6 316



BASIC DÉCO XXL  
SUSPENDEE | G4/P4 164



BASIC MAX  
SUSPENDEE | G1/P1 166



BASIC AMBIENT  
SUSPENDEE | G6 168



RINGO STAR 60MM ACOUSTIC  
SUSPENDEE | G3/P3 200



RINGO STAR 100MM ACOUSTIC  
SUSPENDEE | G1/P1 202

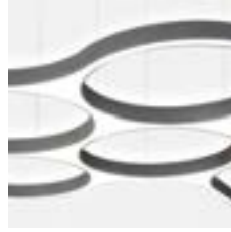

RINGO STAR CLUSTER  
SUSPENDEE | G3/P3 210



LIQUID LINE X-JUNCTIONS  
SUSPENDEE | G3/P3 232



LIQUID LINE Y-JUNCTIONS  
SUSPENDEE | G3/P3 234

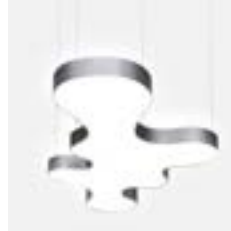

AMORPHICON  
SUSPENDEE | G/P 238



CALEO  
SUSPENDEE | G2/P2 258



CUBIC EVOLUTION  
SUSPENDEE | G4/P4 262

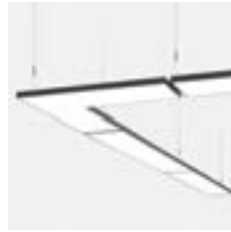

CUBIC EVOLUTION SYSTEM  
SUSPENDEE | G4/P4 264



CUBIC MAX  
SUSPENDEE | G2/P2 276



CUBIC AMBIENT  
SUSPENDEE | G7/P7 278



MATRIC 38MM SQUARE  
SUSPENDEE | G1/R1 280



MATRIC 38MM  
SUSPENDEE DIRECT | G1 302



MATRIC 38MM LENS LOUVER  
SUSP. DIRECT-INDIRECT | R1 304



MATRIC 38MM SUSPENDEE  
DIRECT-INDIRECT | R1 306



MATRIC 81MM  
SUSPENDEE DIRECT-INDIRECT | R6 318



VISION  
SUSPENDEE | G2/P2 320

## ┆ PENDEL | SUSPENDEE | SUSPENSION

MIDPOINT  
SUSPENDED | P7/P8



**DE** LED-Pendelstrahler. Konverter im Leuchtenkörper integriert, wahlweise einfach schaltbar oder stufenlos dimmbar (DALI). LED Engine wahlweise XICATO ARTIST für höchste Lichtqualität mit bester Farbwiedergabe und 5 Jahre Garantie für Farbkonstanz (MacAdams<sub>3</sub>) oder ECO für höchste Energieeffizienz bei optimalem Preis-Leistungsverhältnis und CRI>90. Farbtemperaturen 2700K, 3000K oder 4000K. Austauschbare Linsen-Reflektoroptiken mit sphärischer Facettenoptik. Ausstrahlwinkel: 10° (Spot), 20° (Medium), 35° (Flood) oder 50° (Wide Flood). Standardmäßig klare Abdeckung. Optional zusätzliche Filter oder Wabenraster. Gehäuse aus Aluminium in weiß, silber, schwarz oder champagnerfarben lackiert. Reflektoring zusätzlich in gold- oder kupferfarben erhältlich. Optional Zuleitungskabel in Ausführung soft-touch Farbe Rot oder Schwarz.

**EN** LED pendant spotlight. Driver integrated into luminaire body, optionally switchable or dimmable (DALI). LED Engine with XICATO ARTIST for highest light quality and colour rendering, including 5 year warranty for colour consistency (MacAdams 3). Alternatively ECO for highest energy efficiency with optimal price-performance ratio and CRI>90. Colour temperature 2700K, 3000K or 4000K. Replaceable lens reflector optics with spherical faceted optics. Beam angle: 10° (Spot), 20° (Medium), 35° (Flood) or 50° (Wide Flood). Standard clear cover. Optional additional filters or honeycomb grid. Housing made of white, silver, black or champagne coated aluminum. Reflector ring also available in gold or copper colours. Optional soft-touch red or black sheathed power supply cable.

**FR** Projecteur en suspension LED. Driver intégré dans le corps du luminaire, au choix ON/OFF ou graduable (DALI). Module/COB LED XICATO ARTIST en option pour une qualité d'éclairage maximale et un rendu des couleurs exceptionnel + 5 ans de garantie sur le niveau des couleurs (MacAdams 3) ou ECO pour une efficacité énergétique et un rapport qualité-prix optimal + IRC supérieur à 90 inclus. Température de couleur 2700K, 3000K ou 4000K. Réflecteur avec optique de lentille interchangeable et facettes de réflexion sphérique. Angle d'ouverture/faisceau: 10° (Spot), 20° (Medium), 35° (Flood) ou 50° (Wide Flood). Verre de protection et de fermeture standard. Filtrés divers supplémentaires et/ou filtre nid d'abeilles en option. Boîtier en aluminium couleurs blanc, argent, noir ou titane laqué.

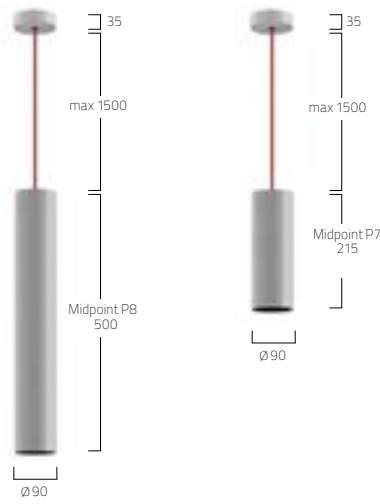

PRODUCT-CODE:	P	P7	B	S	E	-	9	27	F	M	-	B	K	R
PRODUCT FAMILY	P: Midpoint													
TYPE	P7: Suspended, Tube: 215mm, P8: Suspended, Tube: 500mm													
BEAM ANGLE	A: Spot 10°, B: Medium 20°, C: Flood 35°, D: Wide Flood 50°													
SURFACE FINISH	W: Snow White, V: Ivory White, S: Radiant Silver, B: Jet Black, H: Champagne Silver													
CONTROL GEAR	E: On/Off, L: DALI													
COLOUR RENDER.	9: CRI>90													
COLOUR TEMP.	27: 2700K, 30: 3000K, 40: 4000K													
LED-ENGINE	F: Eco [Ra>90], A: Artist [Ra>97, Xicato]													
POWER	E: Low Power, M: Medium Power													
OPTIC RING	W: Snow White, V: Ivory White, S: Radiant Silver, B: Jet Black, H: Champagne Silver, G: Satin Gold, K: Satin Copper													
COVER	K: Clear Cover [Standard], P: Prismatic Lens, H: Honeycomb Louver, B: Dichroic Filter [Bread], M: Dichroic Filter [Meat]													
CABLE COLOUR	T: Transparent, R: Red, B: Black													

SPOT 10° LED ENGINE ECO, MEDIUM POWER

Mounting Height	Illuminance [Lux] center/side	Beam Diameter
1 m	25250/12700	0.24 m
2 m	6312/3175	0.48 m
3 m	2806/1411	0.72 m
4 m	1578/794	0.95 m

MEDIUM 20° LED ENGINE ECO, MEDIUM POWER

Mounting Height	Illuminance [Lux] center/side	Beam Diameter
1 m	17447/8455	0.32 m
2 m	4362/2114	0.64 m
3 m	1939/939	0.96 m
4 m	1090/528	1.30 m

FLOOD 35° LED ENGINE ECO, MEDIUM POWER

Mounting Height	Illuminance [Lux] center/side	Beam Diameter
1 m	6251/2731	0.63 m
2 m	1563/683	1.30 m
3 m	695/303	1.90 m
4 m	391/171	2.50 m

WIDE FLOOD 50° LED ENGINE ECO, MEDIUM POWER

Mounting Height	Illuminance [Lux] center/side	Beam Diameter
1 m	3550/1319	0.94 m
2 m	887/330	1.90 m
3 m	394/147	2.80 m
4 m	222/82	3.80 m

LED Engine	2700K	3000K	4000K
Eco Low Power [20W]	1230	1350	1440
Eco Medium Power [31W]	1660	1860	2020
Artist Low Power [21W]	1040	1090	1190
Artist Medium Power [33W]	1400	1480	1560

LED Engine	2700K	3000K	4000K
Eco Low Power [20W]	1580	1740	1850
Eco Medium Power [31W]	2360	2640	2870
Artist Low Power [21W]	1330	1390	1510
Artist Medium Power [33W]	1980	2110	2220

LED Engine	2700K	3000K	4000K
Eco Low Power [20W]	1530	1680	1790
Eco Medium Power [31W]	2280	2550	2780
Artist Low Power [21W]	1290	1350	1470
Artist Medium Power [33W]	1930	2060	2160

LED Engine	2700K	3000K	4000K
Eco Low Power [20W]	1440	1580	1680
Eco Medium Power [31W]	2230	2490	2710
Artist Low Power [21W]	1250	1310	1430
Artist Medium Power [33W]	1910	2040	2140





# RINGO STAR + MIDPOINT SUSPENDED



**DE** LED-Pendelleuchte. Direkt-indirekt oder rein direktstrahlend. Zusätzliche Midpoint Spotlights für akzentuierte Beleuchtung, Strahlerpositionierung auf dem Innenring nach Vorgabe. Leuchtenkörper aus Aluminiumprofil mit 100mm Lichtspurbreite. 13 verschiedene Durchmesser von 600mm bis 8000mm. Oberfläche silber, weiß, graphit, schwarz, champagner oder kupferfarben lackiert. Weitere Oberflächenoptionen siehe Lightnet-Surface-Collection oder RAL nach Wahl. Microprismenoptik mit optimierter Blendungsbegrenzung speziell für Office-Anwendungen. Satinierter Opaldiffusor für Allgemeinbeleuchtung mit max. Transmissionsgrad und homogener Lichtpunktauflösung. Konverter in Leuchtengehäuse integriert, wahlweise einfach schaltbar oder stufenlos dimmbar (1-10V, DALI, Touch-Dim, Casambi). Farbtemperaturen 2200K, 2700K, 3000K, 3500K, 4000K oder 6500K. Binning initial  $\leq$  MacAdam 3. Farbwiedergabe CRI>80 oder CRI>90. Stufenlos höhenverstellbare Zentral-Seilabhängung oder Parallel-Seilabhängung mit transparent ummantelter Zuleitung.

**EN** LED pendant luminaire. Direct-indirect or Direct Only light distribution. Additional Midpoint spotlights for accentuated lighting, spotlight arrangement on the inner ring according to specification. Luminaire body made of aluminium profile with 100mm track width. 13 different diameters from 600mm to 8000mm. Surface silver, white, graphite, black, champagne or copper coated. Further surface options see Lightnet-Surface-Collection or RAL of your choice. Microprismatic with optimized glare reduction especially for workplaces. Satin opal diffuser for general lighting with maximum transmittance and homogeneous lighting. Converter integrated into luminaire housing, optionally switchable or dimmable (1-10V, DALI, Touch-Dim, Casambi). Colour temperatures 2200K, 2700K, 3000K, 3500K, 4000K or 6500K. Binning initial  $\leq$  MacAdam 3. Colour rendering CRI>80 or CRI>90. Height-adjustable Central Suspension or parallel-cord suspension with transparent power supply cable.

**FR** Luminaire LED suspendu. Éclairage direct/indirect ou seulement direct. Projecteurs supplémentaires pour un éclairage accentué, disposition des projecteurs sur la bague intérieure selon les spécifications. Corps du luminaire en profilé aluminium avec 100mm de largeur du spèctre lumineux. 13 diamètres différents de 600mm à 8000mm. Surface laquée argent, blanc, graphite, noir, champagne ou cuivre. Autres options de finition voir Lightnet-Surface-Collection ou RAL au choix. Diffuseur microprismatique optimisé pour un éblouissement limité et adapté aux bureaux. Diffuseur opale satiné pour un éclairage général et une transmission maximale et homogène. Driver intégré dans le luminaire, au choix ON/OFF ou graduable (1-10V, DALI, Touch-Dim, Casambi). Température de couleur 2200K, 2700K, 3000K, 3500K, 4000K ou 6500K. Binning initial  $\leq$  Mac Adam 3. Rendu de couleur CRI>80 ou CRI>90. Suspension centrale ou parallèle réglable en hauteur avec câble d'alimentation transparent.



Minimal suspension height for the central suspension

D [mm]	H [mm]
600	500
900	700
1200	1000
1500	1300
2000	1500

**PRODUCT-CODE:** R P1 O S D - 8 30 M - D1500 - U - M

- PRODUCT FAMILY - R: Ringo Star
- TYPE - P1: Direct-Indirect, G1: Direct Only
- OPTICAL SYSTEM - O: Opal, A: Microprismatic
- SURFACE FINISH - W: Snow White, V: Ivory White, S: Radiant Silver, U: Urban Graphite, B: Jet Black, H: Champagne Silver, K: Satin Copper
- CONTROL GEAR - E: On/Off, L: DALI, D: 1-10V, H: Touch-Dim, C: Casambi, U: Separately Dimmable DALI
- COLOUR REND. - 8: CRI>80, 9: CRI>90, F: Full Spectrum
- COLOUR TEMP. - 22: 2200K, 27: 2700K, 30: 3000K, 35: 3500K, 40: 4000K, 65: 6500K, TW: Tunable White 2700-6500K
- POWER - E: Low Power, M: Medium Power
- SIZE - Luminaire Diameter in mm: D600, D900, D1200, D1500, D2000, D2500, D3000, D3500, D4000, D5000, D6000, D7000, D8000
- SUSPENSION - U: Central Suspension (max D2000), K: Parallel Suspension
- MIDPOINT - M: Please specify separately the amount, the positioning and the type of Midpoint spotlights



Photometrical data see Midpoint-C6 and Ringo Star-G1/P1



# BASIC SUSPENDED





MABLEDON PLACE DAY THREE & HALO RESTAURANT, LONDON, UK  
BASIC-P1

# BASIC SUSPENDED



HUMBOLDT UNIVERSITÄT BERLIN, GERMANY  
BASIC-P1



BUCHHANDLUNG ERNSTER,  
CLOCHE D'OR SHOPPING CENTER, LUXEMBOURG  
BASIC-G1



TAUNUSTURM FRANKFURT, GERMANY  
BASIC-G5



THE HUB, DUBLIN CITY UNIVERSITY, DUBLIN, IRELAND  
BASIC-G6

BASIC SUPERFLAT  
SUSPENDED | G7/P7



**DE** LED-Pendelleuchte. Direkt-indirekt oder rein direktstrahlend. Gestufter Leuchtenkörper aus Aluminiumprofil mit lediglich 18mm sichtbarem Rahmenprofil. Oberfläche weiß, silber, graphit, schwarz, champagner oder kupferfarben lackiert. Weitere Oberflächenoptionen siehe Lightnet-Surface-Collection oder RAL nach Wahl. Microprismenoptik mit optimierter Blendungsbegrenzung speziell für Office-Anwendungen. Satinierter Opaldiffusor für Allgemeinbeleuchtung mit max. Transmissionsgrad und homogener Lichtpunktauflösung. Konverter in Leuchtengehäuse integriert, wahlweise einfach schaltbar oder stufenlos dimmbar (1-10V, DALI, Touch-Dim, Casambi). Farbtemperaturen 2200K, 2700K, 3000K, 3500K, 4000K oder 6500K. Binning initial  $\leq$  MacAdam 3. Colour rendering CRI>80 oder CRI>90. Höhenverstellbare Zentral-Seilabhangung mit transparent ummantelter Zuleitung oder Pendelrohrabhangung. Auf Anfrage: Integration von Notlichtkomponenten, Sensortechnologie.

**EN** LED pendant luminaire. Direct-indirect or Direct Only light distribution. Tiered luminaire body made of aluminium profile with only 18mm visible frame. Surface white, silver, graphite, black, champagne or copper coated. Further surface options see Lightnet-Surface-Collection or RAL of your choice. Microprismatic with optimized glare reduction especially for workplaces. Satin opal diffuser for general lighting with maximum transmittance and homogeneous lighting. Converter integrated into luminaire housing, optionally switchable or dimmable (1-10V, DALI, Touch-Dim, Casambi). Colour temperatures 2200K, 2700K, 3000K, 3500K, 4000K or 6500K. Binning initial  $\leq$  MacAdam 3. Colour rendering CRI>80 or CRI>90. Height-adjustable Central Suspension with transparent power supply cable or rod suspension. On request: Integration of emergency lighting components, sensor technology.

**FR** Luminaire LED suspendu. clairage direct/indirect ou seulement direct. Corps du luminaire tag en profil aluminium avec cadre visible de seulement 18mm. Surface laque blanc, argent, graphite, noir, champagne ou cuivre. Autres options de finition voir Lightnet-Surface-Collection ou RAL au choix. Diffuseur microprismatique optimis pour un blouissement limit et adapt aux bureaux. Diffuseur opale satin pour un clairage gnral et une transmission maximale et homogne. Driver intgr dans le luminaire, au choix ON/OFF ou graduable (1-10V, DALI, Touch-Dim, Casambi). Temprature de couleur 2200K, 2700K, 3000K, 3500K, 4000K ou 6500K. Binning initial  $\leq$  Mac Adam 3. Rendu de couleur CRI>80 ou CRI>90. Suspension centrale  filins rglables par tendeur rapide avec cble d'alimentation transparent ou suspension rigide tubulaire. Sur demande: Intgration de composants d'clairage de secours ou de capteurs.

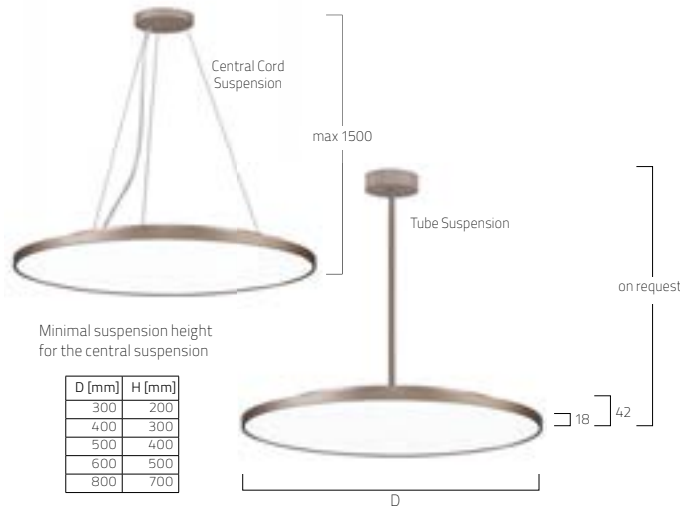

**PRODUCT-CODE:** B P 7 A S D - 8 30 M - D300 - U

- PRODUCT FAMILY – B: Basic
- TYPE – P7: Direct-Indirect, G7: Direct Only
- OPTICAL SYSTEM – A: Microprismatic, O: Opal
- SURFACE FINISH – W: Snow White, V: Ivory White, S: Radiant Silver, U: Urban Graphite, B: Jet Black, H: Champagne Silver, K: Satin Copper
- CONTROL GEAR – E: On/Off, L: DALI, D: 1-10V, H: Touch-Dim, C: Casambi
- COLOUR REND. – 8: CRI>80, 9: CRI>90
- COLOUR TEMP. – 22: 2200K, 27: 2700K, 30: 3000K, 35: 3500K, 40: 4000K, 65: 6500K, TW: Tunable White 2700-6500K
- POWER – M: Medium Power, H: High Power
- SIZE – Luminaire Diameter in mm: D300, D400, D500, D600, D800
- SUSPENSION – U: Central Suspension, P: Tube Suspension [min. D400]
- ON REQUEST – Multisensor, Radar Sensor, Emergency Module, Cable Colour: Black, Red

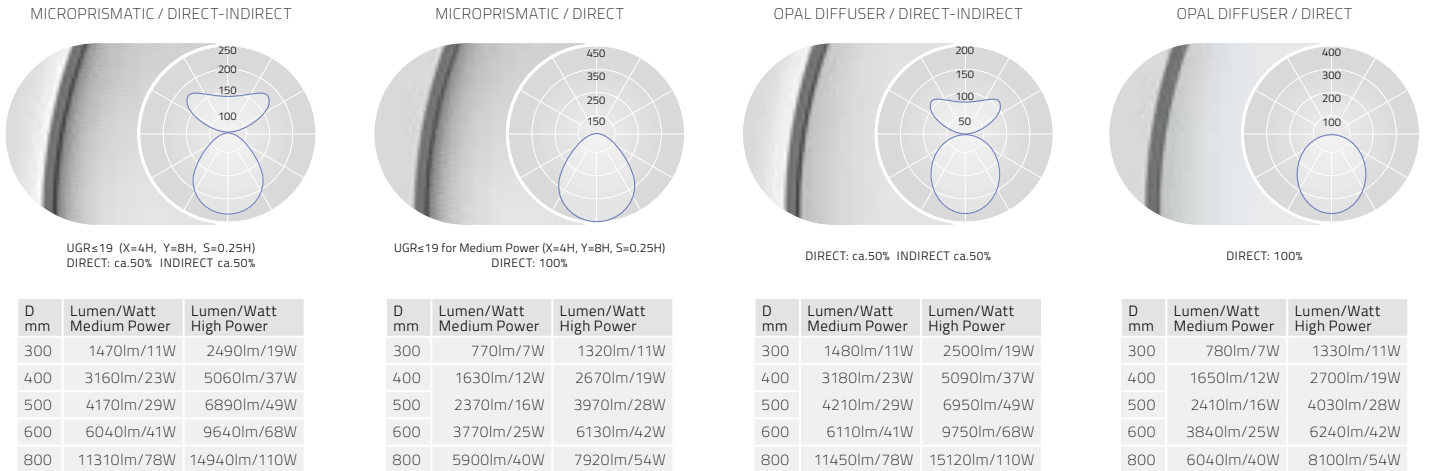

Lumen Values: Luminarie luminous flux at 4000K/CRI>80. Other configurations on request.





BASIC NEO  
SUSPENDED | G5/P5



**DE** LED-Pendelleuchte. Direkt-indirekt oder rein direktstrahlend. Leuchtenkörper aus Aluminiumprofil mit filigraner Bauhöhe von 38mm ohne zusätzliche Distanzelemente. Oberfläche weiß, silber, graphit, schwarz, champagner oder kupferfarben lackiert. Weitere Oberflächenoptionen siehe Lightnet-Surface-Collection oder RAL nach Wahl. Microprismenoptik mit optimierter Blendungsbegrenzung speziell für Office-Anwendungen. Satinierter Opaldiffusor für Allgemeinbeleuchtung mit max. Transmissionsgrad und homogener Lichtpunktauflösung. Konverter in Leuchtengehäuse integriert, wahlweise einfach schaltbar oder stufenlos dimmbar (1-10V, DALI, Touch-Dim, Casambi). Farbtemperaturen 2200K, 2700K, 3000K, 3500K, 4000K oder 6500K. Binning initial  $\leq$  MacAdam 3. Farbwiedergabe CRI>80 oder CRI>90. Stufenlos höhenverstellbare Zentral-Seilabhangung mit transparent ummantelter Zuleitung oder Pendelrohrabhangung. Auf Anfrage: Integration von Notlichtkomponenten, Sensortechnologie.

**EN** LED pendant luminaire. Direct-indirect or Direct Only light distribution. Luminaire body made of aluminium profile with filigree overall height of 38mm without additional spacers. Surface white, silver, graphite, black, champagne or copper coated. Further surface options see Lightnet-Surface-Collection or RAL of your choice. Microprismatic with optimized glare reduction especially for workplaces. Satin opal diffuser for general lighting with maximum transmittance and homogeneous lighting. Converter integrated into luminaire housing, optionally switchable or dimmable (1-10V, DALI, Touch-Dim, Casambi). Colour temperatures 2200K, 2700K, 3000K, 3500K, 4000K or 6500K. Binning initial  $\leq$  MacAdam 3. Colour rendering CRI>80 or CRI>90. Height-adjustable Central Suspension with transparent power supply cable or rod suspension. On request: Integration of emergency lighting components, sensor technology.

**FR** Luminaire LED suspendu. clairage direct/indirect ou seulement direct. Corps du luminaire en profil aluminium avec une paisseur fine de 38mm sans espacements/entretoises supplementaires. Surface laquee blanc, argent, graphite, noir, champagne ou cuivre. Autres options de finition voir Lightnet-Surface-Collection ou RAL au choix. Diffuseur microprismatique optimise pour un blouissement limite et adapte aux bureaux. Diffuseur opale satine pour un clairage general et une transmission maximale et homogene. Driver integre dans le luminaire, au choix ON/OFF ou graduable (1-10V, DALI, Touch-Dim, Casambi). Temperature de couleur 2200K, 2700K, 3000K, 3500K, 4000K ou 6500K. Binning initial  $\leq$  MacAdam 3. Rendu de couleur CRI>80 ou CRI>90. Suspension centrale  filins reglables par tendeur rapide avec cable d'alimentation transparent ou suspension rigide tubulaire. Sur demande: Integration de composants d'clairage de secours ou de capteurs.

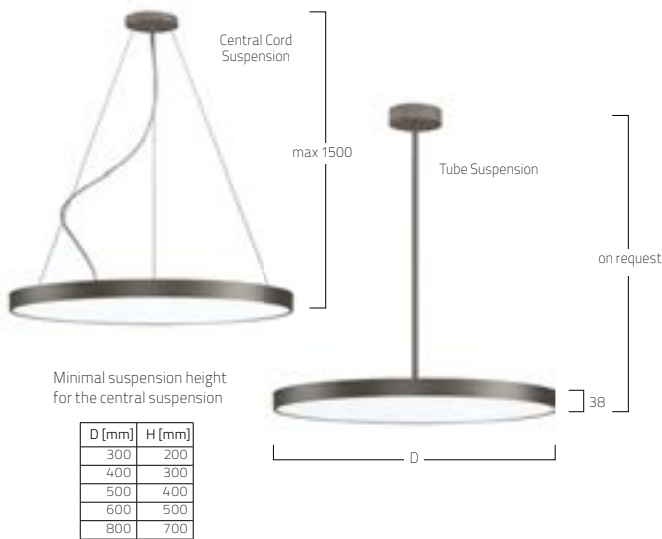

**PRODUCT-CODE:** **B P5 A S D - 8 30 M - D300 - U**

PRODUCT FAMILY – **B** Basic  
TYPE – **P5** Direct-Indirect, **G5** Direct Only  
OPTICAL SYSTEM – **A** Microprismatic, **O** Opal  
SURFACE FINISH – **W** Snow White, **V** Ivory White, **S** Radiant Silver, **U** Urban Graphite, **B** Jet Black, **H** Champagne Silver, **K** Satin Copper  
CONTROL GEAR – **E** On/Off, **L** DALI, **D** 1-10V, **H** Touch-Dim, **C** Casambi  
COLOUR REND. – **8** CRI>80, **9** CRI>90  
COLOUR TEMP. – **22** 2200K, **27** 2700K, **30** 3000K, **35** 3500K, **40** 4000K, **65** 6500K, **TW** Tunable White 2700-6500K  
POWER – **M** Medium Power, **H** High Power  
SIZE – Luminaire Diameter in mm: **D300 D400 D500 D600 D800**  
SUSPENSION – **U** Central Suspension, **P** Tube Suspension [min. D400]  
ON REQUEST – Multisensor, Radar Sensor, Emergency Module, Cable Colour: Black, Red

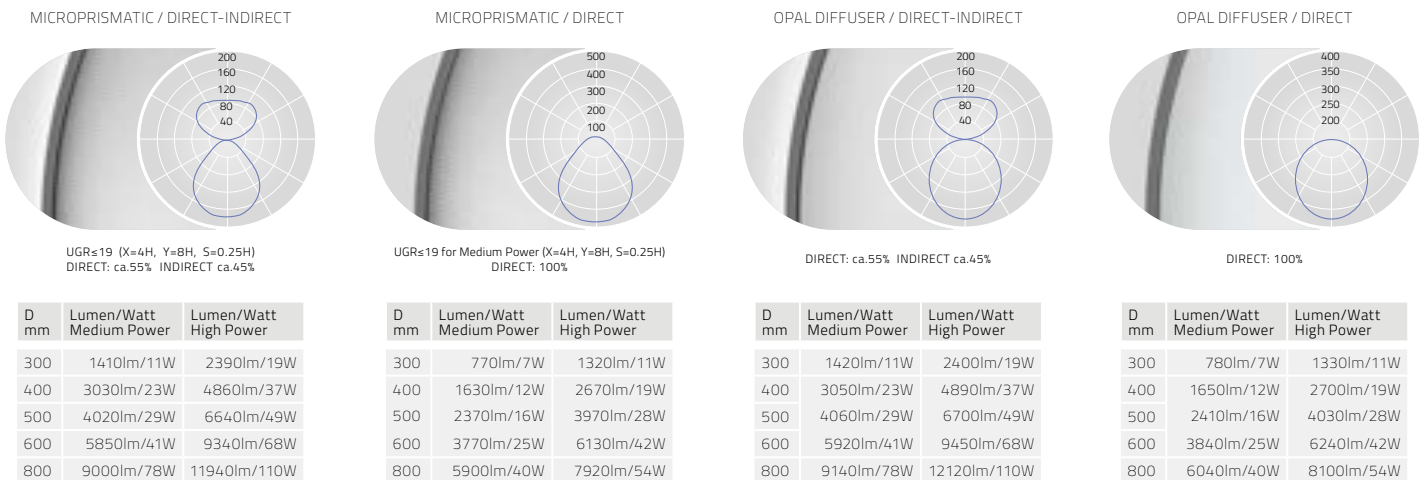

Lumen Values: Luminaire luminous flux at 4000K/CRI>80. Other configurations on request.



BASIC DÉCO  
SUSPENDED | G3/P3



**DE** LED-Pendelleuchte. Direkt-indirekt oder rein direktstrahlend. Leuchtenkörper aus Aluminiumprofil mit Bauhöhe 58mm. Gehäuse-Außenfläche und dekorativer Reflektorring in unterschiedlichen Lackierungen und Kombinationen erhältlich, z.B. weiß, silber, graphit, schwarz, gold oder kupferfarben. Zu Oberflächenoptionen- und Kombinationen siehe Lightnet-Surface-Collection oder Bi-Colour-Auswahl. Rückversetzte Microprismenoptik mit optimierter Blendungsbegrenzung speziell für Office-Anwendungen. Satiniertes Opaldiffusor für Allgemeinbeleuchtung mit max. Transmissionsgrad und homogener Lichtpunktauflösung. Converter in Leuchtengehäuse integriert, wahlweise einfach schaltbar oder stufenlos dimmbar (1-10V, DALI, Touch-Dim, Casambi). Farbtemperaturen 2200K, 2700K, 3000K, 3500K, 4000K oder 6500K. Binning initial  $\leq$  MacAdam 3. Farbwiedergabe CRI>80 oder CRI>90.

**EN** LED pendant luminaire. Direct-indirect or Direct Only light distribution. Luminaire body made of aluminium profile with overall height of 58mm. Outer housing and decorative reflector ring available in various finishes and combinations, e.g. white, silver, graphite, black, gold or copper coated. For surface options and combinations check Lightnet Surface Collection or Bi-Colour Selection. Recessed Microprismatic with optimized glare reduction especially for workplaces. Satin opal diffuser for general lighting with maximum transmittance and homogeneous lighting. Converter integrated into luminaire housing, optionally switchable or dimmable (1-10V, DALI, Touch-Dim, Casambi). Colour temperatures 2200K, 2700K, 3000K, 3500K, 4000K or 6500K. Binning initial  $\leq$  MacAdam 3. Colour rendering CRI>80 or CRI>90.

**FR** Luminaire LED suspendu. Éclairage direct/in-direct ou seulement direct. Corps du luminaire en profilé aluminium avec une hauteur de 58mm. Surface du luminaire et réflecteur/bague décorative disponible en différentes combinaisons et couleurs au choix, Ex: blanc, argent, graphite, noir ou cuivre. Pour les options et combinaisons de finitions, voir Lightnet Surface Collection ou Bi-Colour Selection. Diffuseur microprismatique encastré avec réduction optimisée de l'éblouissement, spécialement pour les postes de travail. Diffuseur opale satiné pour un éclairage général et une transmission maximale et homogène. Driver intégré dans le luminaire, au choix ON/OFF ou graduable (1-10V, DALI, Touch-Dim, Casambi). Température de couleur 2200K, 2700K, 3000K, 3500K, 4000K ou 6500K. Binning initial  $\leq$  MacAdam 3. Rendu de couleur CRI>80 ou CRI>90.

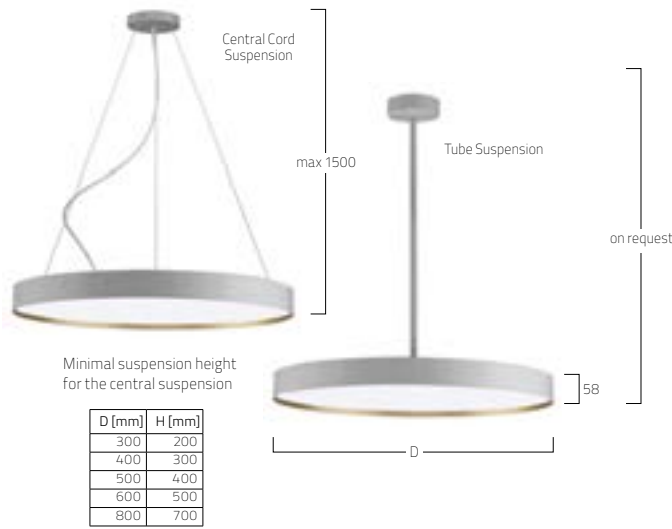

**PRODUCT-CODE: B P3 A S D - 8 30 M - D300 - U G**

- PRODUCT FAMILY – **B** Basic
- TYPE – **P3** Direct-Indirect, **G3** Direct Only
- OPTICAL SYSTEM – **A** Microprismatic, **O** Opal
- SURFACE FINISH – **W** Snow White, **V** Ivory White, **S** Radiant Silver, **U** Urban Graphite, **B** Jet Black, **H** Champagne Silver, **K** Satin Copper
- CONTROL GEAR – **E** On/Off, **L** DALI, **D** 1-10V, **H** Touch-Dim, **C** Casambi
- COLOUR REND. – **8** CRI>80, **9** CRI>90
- COLOUR TEMP. – **22** 2200K, **27** 2700K, **30** 3000K, **35** 3500K, **40** 4000K, **65** 6500K, **TW** Tunable White 2700-6500K
- POWER – **M** Medium Power, **H** High Power
- SIZE – Luminaire Diameter in mm: **D300**, **D400**, **D500**, **D600**, **D800**
- SUSPENSION – **U** Central Suspension, **P** Tube Suspension [min. D400]
- REFLECTOR – **W** Snow White, **V** Ivory White, **S** Radiant Silver, **U** Urban Graphite, **B** Jet Black, **H** Champagne Silver, **K** Satin Copper, **G** Satin Gold
- ON REQUEST – Multisensor, Radar Sensor, Emergency Module, Cable Colour: Black, Red

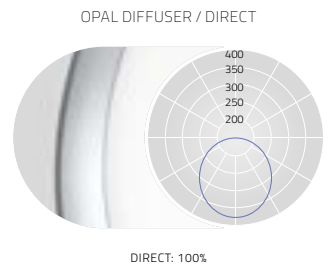
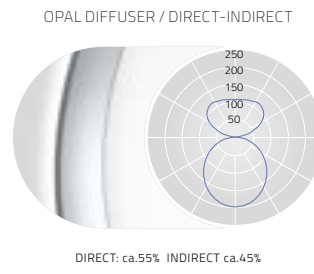
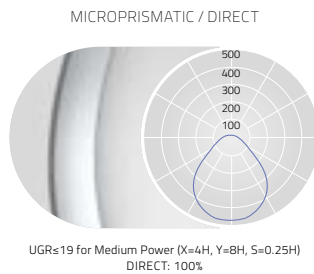
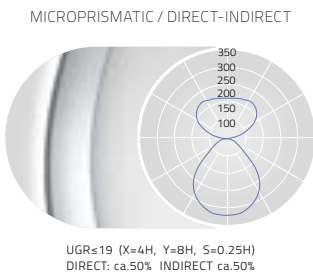

D mm	Lumen/Watt Medium Power	Lumen/Watt High Power
300	1710lm/14W	2930lm/25W
400	3360lm/26W	5130lm/41W
500	4810lm/37W	7720lm/61W
600	6230lm/45W	9020lm/68W
800	11300lm/86W	13790lm/110W

D mm	Lumen/Watt Medium Power	Lumen/Watt High Power
300	920lm/8W	1590lm/13W
400	1750lm/14W	2760lm/21W
500	2730lm/22W	4510lm/36W
600	3950lm/28W	5810lm/42W
800	5960lm/43W	7360lm/54W

D mm	Lumen/Watt Medium Power	Lumen/Watt High Power
300	1690lm/14W	2900lm/25W
400	3360lm/26W	5130lm/41W
500	4830lm/37W	7780lm/61W
600	6330lm/45W	9130lm/68W
800	11460lm/86W	13990lm/110W

D mm	Lumen/Watt Medium Power	Lumen/Watt High Power
300	900lm/8W	1560lm/13W
400	1750lm/14W	2760lm/21W
500	2750lm/22W	4570lm/36W
600	4050lm/28W	5920lm/42W
800	6120lm/43W	7560lm/54W

Lumen Values: Luminaire luminous flux at 4000K/CRI>80. Other configurations on request.



BASIC DÉCO XXL  
SUSPENDED | G4/P4



**DE** LED-Pendelleuchte. Direkt-indirekt oder rein direkt-strahlend. Leuchtenkörper aus Aluminiumprofil mit Bauhöhe 100mm. Gehäuse-Außenfläche und dekorativer Reflektorring in unterschiedlichen Lackierungen und Kombinationen erhältlich, z.B. weiß, silber, graphit, schwarz, gold oder kupferfarben. Zu Oberflächenoptionen- und Kombinationen siehe Lightnet-Surface-Collection oder Bi-Colour-Auswahl. Rückversetzte Microprismenoptik mit optimierter Blendungsbegrenzung speziell für Office-Anwendungen. Opaldiffusor aus satiniertem Acrylglas. Konverter in Leuchtengehäuse integriert, wahlweise einfach schaltbar oder stufenlos dimmbar (1-10V, DALI, Touch-Dim, Casambi). Farbtemperaturen 2200K, 2700K, 3000K, 3500K, 4000K oder 6500K. Binning initial  $\leq$  MacAdam 3. Farbwiedergabe CRI>80 oder CRI>90.

**EN** LED pendant luminaire. Direct-indirect or Direct Only light distribution. Luminaire body made of aluminium profile with overall height of 100mm. Outer housing and decorative reflector ring available in various finishes and combinations, e.g. white, silver, graphite, black, gold or copper coated. For surface options and combinations check Lightnet Surface Collection or Bi-Colour Selection. Recessed microprismatic screen with optimized glare reduction especially for workplaces. Opal diffuser made of acrylic glass. Converter integrated into luminaire housing, optionally switchable or dimmable (1-10V, DALI, Touch-Dim, Casambi). Colour temperatures 2200K, 2700K, 3000K, 3500K, 4000K or 6500K. Binning initial  $\leq$  MacAdam 3. Colour rendering CRI>80 or CRI>90.

**FR** Luminaire LED suspendu. Éclairage direct/indirect ou seulement direct. Corps du luminaire en profilé aluminium avec une hauteur de 100mm. Surface du luminaire et réflecteur/bague décorative disponible en différentes combinaisons et couleurs au choix, Ex: blanc, argent, graphite, noir ou cuivre. Pour les options et combinaisons de finitions, voir Lightnet Surface Collection ou Bi-Colour Selection. Diffuseur microprismatique encastré avec réduction optimisée de l'éblouissement, spécialement pour les postes de travail. Diffuseur opale en verre acrylique. Driver intégré dans le luminaire, au choix ON/OFF ou graduable (1-10V, DALI, Touch-Dim, Casambi). Température de couleur 2200K, 2700K, 3000K, 3500K, 4000K ou 6500K. Binning initial  $\leq$  MacAdam 3. Rendu de couleur CRI>80 ou CRI>90.

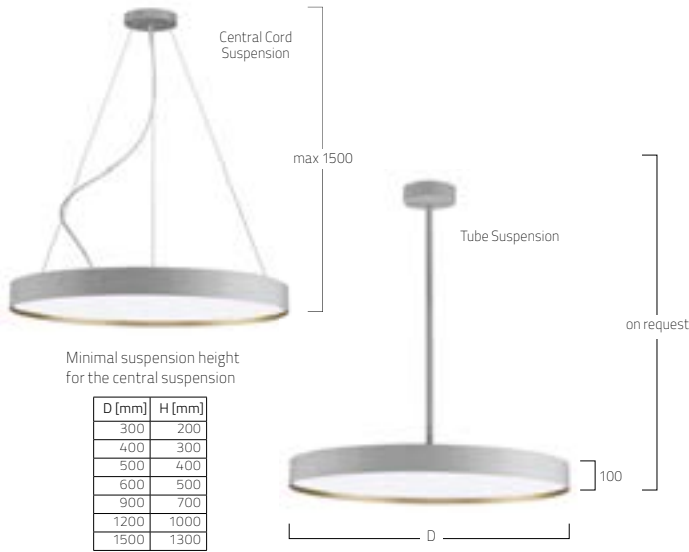

**PRODUCT-CODE: B P4 A S D - 8 30 M - D300 - U G**

- PRODUCT FAMILY - **B** Basic
- TYPE - **P4** Direct-Indirect, **G4** Direct Only
- OPTICAL SYSTEM - **A** Microprismatic [max D1200], **O** Opal
- SURFACE FINISH - **W** Snow White, **V** Ivory White, **S** Radiant Silver, **U** Urban Graphite, **B** Jet Black, **H** Champagne Silver, **K** Satin Copper
- CONTROL GEAR - **E** On/Off, **L** DALI, **D** 1-10V, **H** Touch-Dim, **C** Casambi, **M** Multisensor
- COLOUR REND. - **8** CRI>80, **9** CRI>90, **F** Full Spectrum
- COLOUR TEMP. - **22** 2200K, **27** 2700K, **30** 3000K, **35** 3500K, **40** 4000K, **65** 6500K, **TW** Tunable White 2700-6500K [D400-D1200]
- POWER - **E** Low Power, **M** Medium Power
- SIZE - Luminaire Diameter in mm: **D300, D400, D500, D600, D900, D1200, D1500**
- SUSPENSION - **U** Central Suspension, **K** Parallel Suspension, **P** Tube Suspension [only D400-D900]
- REFLECTOR - **W** Snow White, **V** Ivory White, **S** Radiant Silver, **U** Urban Graphite, **B** Jet Black, **H** Champagne Silver, **K** Satin Copper, **G** Satin Gold
- ON REQUEST - Radar Sensor, Emergency Module, Cable Colour: Black, Red



MICROPRISMATIC / DIRECT-INDIRECT

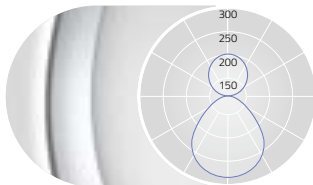

UGR $\leq$ 19 (X=4H, Y=8H, S=0.25H)  
DIRECT: ca.60% INDIRECT ca.40%

MICROPRISMATIC / DIRECT

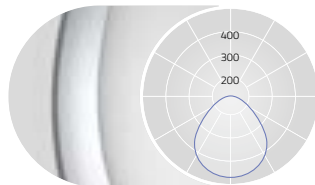

UGR $\leq$ 19 for Low Power (X=4H, Y=8H, S=0.25H)  
DIRECT: 100%

OPAL DIFFUSER / DIRECT-INDIRECT



DIRECT: ca.60% INDIRECT ca.40%

OPAL DIFFUSER / DIRECT



DIRECT: 100%

D mm	Lumen/Watt Low Power	Lumen/Watt Medium Power
300	1440lm/12W	2810lm/21W
400	2800lm/19W	5740lm/40W
500	3970lm/26W	7760lm/50W
600	8370lm/52W	12900lm/87W
900	11220lm/86W	17310lm/144W
1200	18260lm/157W	28420lm/266W

D mm	Lumen/Watt Low Power	Lumen/Watt Medium Power
300	880lm/8W	1730lm/14W
400	1740lm/13W	3580lm/29W
500	2480lm/18W	4860lm/35W
600	3860lm/28W	7250lm/52W
900	6800lm/59W	11490lm/106W
1200	11890lm/107W	20110lm/195W

D mm	Lumen/Watt Low Power	Lumen/Watt Medium Power
300	1470lm/12W	2860lm/21W
400	2850lm/19W	5850lm/40W
500	4040lm/26W	7910lm/50W
600	8490lm/52W	13120lm/87W
900	11420lm/86W	17650lm/144W
1200	18620lm/157W	29010lm/266W
1500	26850lm/235W	41410lm/394W

D mm	Lumen/Watt Low Power	Lumen/Watt Medium Power
300	910lm/8W	1780lm/14W
400	1790lm/13W	3690lm/29W
500	2550lm/18W	5010lm/35W
600	3980lm/28W	7470lm/52W
900	7000lm/59W	11830lm/106W
1200	12250lm/107W	20700lm/195W
1500	17290lm/162W	28950lm/287W

Lumen Values: Luminaire luminous flux at 4000K/CRI>80. Other configurations on request.



BASIC MAX  
SUSPENDED | G1/P1



**DE** LED-Pendelleuchte. Direkt-indirekt oder rein direktstrahlend. Leuchtenkörper aus Aluminiumprofil. 8 verschiedene Durchmesser von 300 bis 2000mm. Oberfläche weiß, silber, graphit, schwarz, champagner oder kupferfarben lackiert. Weitere Oberflächenoptionen siehe Lightnet-Surface-Collection oder RAL nach Wahl. Microprismenoptik mit optimierter Blendungsbegrenzung speziell für Office-Anwendungen (bis max. DM1200). Opaldiffusor aus satiniertem Acrylglas, ab DM1500 mit opaler Stretchfolie für Allgemeinbeleuchtung. Konverter in Leuchtengehäuse integriert, wahlweise einfach schaltbar oder stufenlos dimmbar (1-10V, DALI, Touch-Dim, Casambi). Farbtemperaturen 2200K, 2700K, 3000K, 3500K, 4000K oder 6500K. Binning initial  $\leq$  MacAdam 3. Farb wiedergabe CRI $>$ 80 oder CRI $>$ 90. Stufenlos höhenverstellbare Zentral-Seilabhängung (max. DM1500) oder Parallel-Seilabhängung mit transparent ummantelter Zuleitung, alternativ Pendelrohrabhängung. Auf Anfrage: Integration von Notlichtkomponenten, Sensortechnologie.

**EN** LED pendant luminaire. Direct-indirect or Direct Only light distribution. Luminaire body made of aluminum profile. 8 different diameters from 300mm to 2000mm. Surface white, silver, graphite, black, champagne or copper coated. Further surface options see Lightnet-Surface-Collection or RAL of your choice. Microprismatic with optimized glare reduction especially for workplaces (up to max. DM1200). Opal diffuser made of acrylic glass, starting with DM1500 with opal stretch foil. Converter integrated into luminaire housing, optionally switchable or dimmable (1-10V, DALI, Touch-Dim, Casambi). Colour temperatures 2200K, 2700K, 3000K, 3500K, 4000K or 6500K. Binning initial  $\leq$  MacAdam 3. Colour rendering CRI $>$ 80 or CRI $>$ 90. Height-adjustable Central Suspension (max. DM1500) or Parallel Suspension with transparent power supply cable, alternatively rod suspension. On request: Integration of emergency lighting components, sensor technology.

**FR** Luminaire LED suspendu. Éclairage direct/indirect ou seulement direct. Corps du luminaire en profilé aluminium. 8 diamètres différents de 300mm à 2000mm. Surface laquée blanc, argent, graphite, noir, champagne ou cuivre. Autres options de finition voir Lightnet-Surface-Collection ou RAL au choix. Diffuseur/Optique microprismatique avec anti-éblouissement optimisé et dédié au poste de travail/bureau (Diamètre max. 1200mm). Opal diffuser made of acrylic glass, starting with DM1500 with opal stretch foil for general lighting. Driver intégré dans le luminaire, au choix ON/OFF ou graduable (1-10V, DALI, Touch-Dim, Casambi). Température de couleur 2200K, 2700K, 3000K, 3500K, 4000K ou 6500K. Binning initial  $\leq$  MacAdam 3. Rendu de couleur CRI $>$ 80 ou CRI $>$ 90. Suspension centrale réglable en hauteur (max. DM1500) ou suspension à câble parallèle avec câble d'alimentation transparent, en alternative suspension à tige. Sur demande: Intégration de composants d'éclairage de secours ou de capteurs.

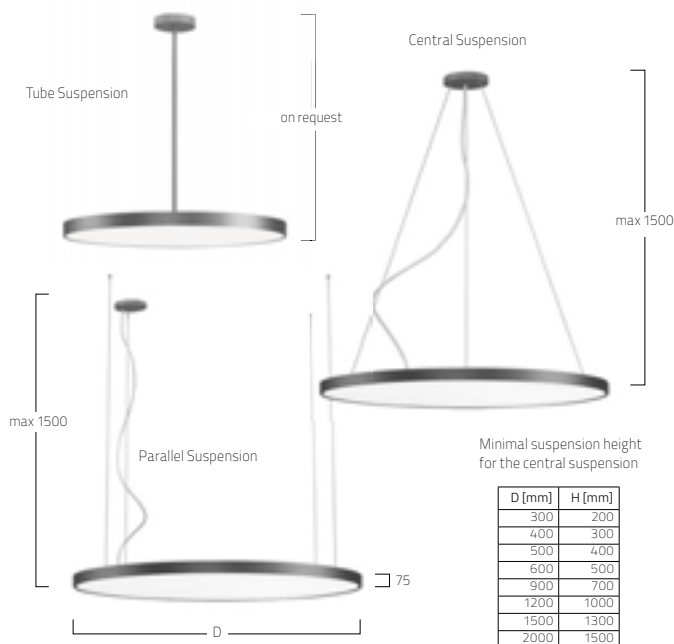

**PRODUCT-CODE:** B P1 O S D - 8 30 M - D300 - U

PRODUCT FAMILY - B: Basic

TYPE - P1: Direct-Indirect, G1: Direct Only

OPTICAL SYSTEM - A: Microprismatic [max  $\phi$ 1200], O: Opal [max  $\phi$ 1200], T: Opal stretch diffuser [ $\phi$ 1500,  $\phi$ 2000]

SURFACE FINISH - W: Snow White, V: Ivory White, S: Radiant Silver, U: Urban Graphite, B: Jet Black, H: Champagne Silver, K: Satin Copper

CONTROL GEAR - E: On/Off, L: DALI, D: 1-10V, H: Touch-Dim, C: Casambi

COLOUR REND. - 8: CRI $>$ 80, 9: CRI $>$ 90, F: Full Spectrum

COLOUR TEMP. - 22: 2200K, 27: 2700K, 30: 3000K, 35: 3500K, 40: 4000K, 65: 6500K, TW: Tunable White 2700-6500K [D400-D1200]

POWER - E: Low Power, M: Medium Power

SIZE - Luminaire Diameter in mm: D300, D400, D500, D600, D900, D1200, D1500, D2000

SUSPENSION - U: Central Suspension [max  $\phi$ 1500], K: Parallel Suspension, P: Tube Suspension [only D400-D900]

ON REQUEST - Multisensor, Radar Sensor, Emergency Module, Cable Colour: Black, Red

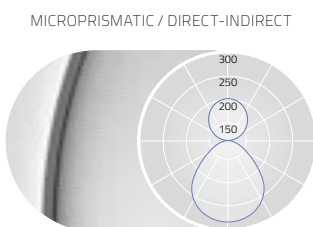

UGR $\leq$ 19 (X=4H, Y=8H, S=0.25H)  
DIRECT: ca.60% INDIRECT ca.40%

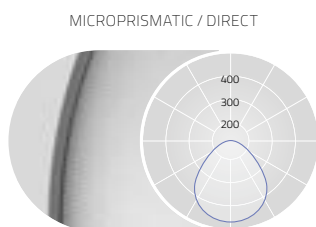

UGR $\leq$ 19 for Low Power (X=4H, Y=8H, S=0.25H)  
DIRECT: 100%

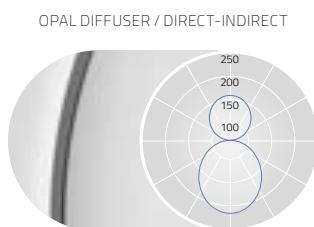

DIRECT: ca.60% INDIRECT ca.40%

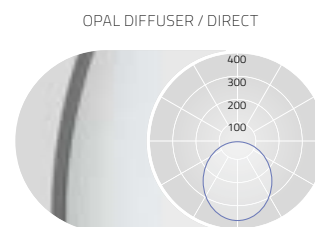

DIRECT: 100%

D mm	Lumen/Watt Low Power	Lumen/Watt Medium Power
300	1440lm/12W	2810lm/21W
400	2800lm/19W	5740lm/40W
500	3970lm/26W	7760lm/50W
600	8370lm/52W	12900lm/87W
900	11220lm/86W	17310lm/144W
1200	18260lm/157W	28420lm/266W

D mm	Lumen/Watt Low Power	Lumen/Watt Medium Power
300	880lm/8W	1730lm/14W
400	1740lm/13W	3580lm/29W
500	2480lm/18W	4860lm/35W
600	3860lm/28W	7250lm/52W
900	6800lm/59W	11490lm/106W
1200	11890lm/107W	20110lm/195W

D mm	Lumen/Watt Low Power	Lumen/Watt Medium Power
300	1470lm/12W	2860lm/21W
400	2850lm/19W	5850lm/40W
500	4040lm/26W	7910lm/50W
600	8490lm/52W	13120lm/87W
900	11420lm/86W	17650lm/144W
1200	18620lm/157W	29010lm/266W
1500	26850lm/235W	41410lm/394W
2000	42600lm/393W	66610lm/668W

D mm	Lumen/Watt Low Power	Lumen/Watt Medium Power
300	910lm/8W	1780lm/14W
400	1790lm/13W	3690lm/29W
500	2550lm/18W	5010lm/35W
600	3980lm/28W	7470lm/52W
900	7000lm/59W	11830lm/106W
1200	12250lm/107W	20700lm/195W
1500	17290lm/162W	28950lm/287W
2000	29860lm/293W	50000lm/526W

Lumen Values: Luminaire luminous flux at 4000K/CRI $>$ 80. Other configurations on request.





BASIC AMBIENT  
SUSPENDED | G6



**DE** LED-Pendelleuchte. Direkt-rundumstrahlend. Leuchtenkörper aus Aluminiumprofil und Diffusor mit 60mm Bauhöhe. Ambientdiffusor aus satiniertem Acrylglas für Allgemeinbeleuchtung. Oberfläche weiß, silber, graphit, schwarz, champagner oder kupferfarben lackiert. Weitere Oberflächenoptionen siehe Lightnet-Surface-Collection oder RAL nach Wahl. Konverter in Leuchtengehäuse integriert, wahlweise einfach schaltbar oder stufenlos dimmbar (1-10V, DALI, Touch-Dim, Casambi). Farbtemperaturen 2200K, 2700K, 3000K, 3500K, 4000K oder 6500K. Binning initial ≤ Mac Adam 3. Farbwiedergabe CRI>80 oder CRI>90. Stufenlos höhenverstellbare Zentral-Seilabhängung mit transparent ummantelter Zuleitung. Auf Anfrage: Integration von Notlichtkomponenten, Sensortechnologie.

**EN** LED pendant luminaire. Omnidirectional light distribution. Luminaire body made of aluminium profile and diffuser with overall height of 60mm. Ambient diffuser made of frosted acrylic glass for general lighting. Surface white, silver, graphite, black, champagne or copper coated. Further surface options see Lightnet-Surface-Collection or RAL of your choice. Converter integrated into luminaire housing, optionally switchable or dimmable (1-10V, DALI, Touch-Dim, Casambi). Colour temperatures 2200K, 2700K, 3000K, 3500K, 4000K or 6500K. Binning initial ≤ MacAdam 3. Colour rendering CRI>80 or CRI>90. Height-adjustable Central Suspension with transparent power supply cable. On request: Integration of emergency lighting components, sensor technology.

**FR** Luminaire LED suspendu. Diffusion de l'éclairage omnidirectionnelle. Corps de luminaire en profilé aluminium avec diffuseur de 60mm de hauteur. Diffuseur AMBIENT en verre satiné acrylique pour diverses applications d'éclairage. Surface laquée blanc, argent, graphite, noir, champagne ou cuivre. Autres options de finition voir Lightnet-Surface-Collection ou RAL au choix. Driver intégré dans le luminaire, au choix ON/OFF ou graduable (1-10V, DALI, Touch-Dim, Casambi). Température de couleur 2200K, 2700K, 3000K, 3500K, 4000K ou 6500K. Binning initial ≤ Mac Adam 3. Rendu de couleur CRI>80 ou CRI>90. Suspension centrale à fils réglables par tendeur rapide avec câble d'alimentation transparent. Sur demande: Intégration de composants d'éclairage de secours ou de capteurs.

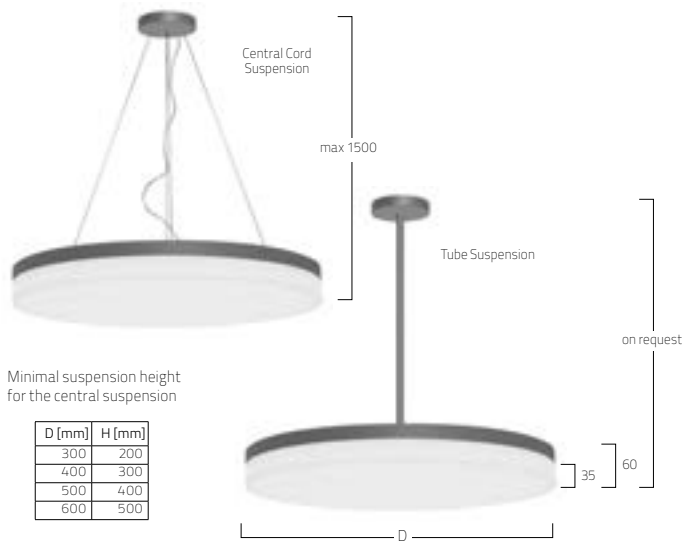

**PRODUCT-CODE: B G6 F S D - 8 30 M - D300 - U**

- PRODUCT FAMILY – **B** Basic
- TYPE – **G6** Direct Only
- OPTICAL SYSTEM – **F** Ambient
- SURFACE FINISH – **W**: Snow White, **V**: Ivory White, **S**: Radiant Silver, **U**: Urban Graphite, **B**: Jet Black, **H**: Champagne Silver, **K**: Satin Copper
- CONTROL GEAR – **E** On/Off, **L** DALI, **D** 1-10V, **H** Touch-Dim, **C** Casambi
- COLOUR REND. – **8**: CRI>80, **9**: CRI>90, **F**: Full Spectrum
- COLOUR TEMP. – **22**: 2200K, **27**: 2700K, **30**: 3000K, **35**: 3500K, **40**: 4000K, **65**: 6500K, **TW**: Tunable White 2700-6500K [D400-D600]
- POWER – **M**: Medium Power, **H**: High Power
- SIZE – Luminaire Diameter in mm: **D300** **D400** **D500** **D600**
- SUSPENSION – **U**: Central Suspension, **P**: Tube Suspension (D400-600)
- ON REQUEST – Radar Sensor, Emergency Module, Cable Colour: Black, Red



**AMBIENT DIFFUSER / DIRECT**

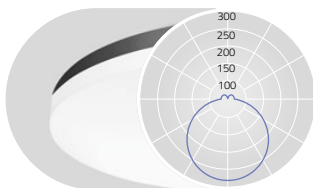

DIRECT: ca.98% INDIRECT: ca.2%

D mm	Lumen/Watt Medium Power	Lumen/Watt High Power
300	920lm/8W	1810lm/14W
400	1830lm/13W	3760lm/29W
500	2600lm/18W	5150lm/35W
600	4080lm/28W	7600lm/52W

Lumen Values: Luminaire luminous flux at 4000K/CRI>80. Other configurations on request.



BEAM ME UP JR.  
SUSPENDED | G3/P3



**DE** LED-Pendelleuchte mit rückversetzter Optik und dekorativem Reflektorring. Direkt-indirekt oder rein direktstrahlend. Leuchtschirm aus hochwertig verarbeitetem, glasfaserverstärktem Kunststoff (Fiberglas). Gehäuse-Außenfläche und dekorativer Reflektorring in unterschiedlichen Lackierungen und Kombinationen erhältlich, z.B. weiß, silber, graphit, schwarz, gold oder kupferfarben lackiert. Zu Oberflächenoptionen- und Kombinationen siehe Lightnet-Surface-Collection oder Bi-Colour-Auswahl. Microprismenoptik mit optimierter Blendungsbegrenzung speziell für Office-Anwendungen. Satinierter Opaldiffusor für Allgemeinbeleuchtung mit max. Transmissionsgrad und homogener Lichtpunktauflösung. Converter in Leuchtgehäuse integriert, wahlweise einfach schaltbar oder stufenlos dimmbar (1-10V, DALI, Touch-Dim, Casambi). Farbtemperaturen 2200K, 2700K, 3000K, 3500K, 4000K oder 6500K. Binning initial  $\leq$  MacAdam 3. Farbwiedergabe CRI>80 oder CRI>90.

**EN** LED pendant luminaire with a setback lens optic in a decorative ring. Direct-indirect or Direct Only light distribution. Luminaire body made of high-quality processed FRP (fiberglass reinforced plastic). Outer housing and decorative reflector ring available in various finishes and combinations, e.g. white, silver, graphite, black, gold or copper coated. For surface options and combinations check Lightnet Surface Collection or Bi-Colour Selection. Microprismatic with optimized glare reduction especially for workplaces. Satin opal diffuser for general lighting with maximum transmittance and homogeneous lighting. Converter integrated into luminaire housing, optionally switchable or dimmable (1-10V, DALI, Touch-Dim, Casambi). Colour temperatures 2200K, 2700K, 3000K, 3500K, 4000K or 6500K. Binning initial  $\leq$  MacAdam 3. Colour rendering CRI>80 or CRI>90.

**FR** Luminaire LED suspendu avec diffuseur/optique en retrait et bague décorative. Éclairage direct/indirect ou seulement direct. Abat-Jour en matière travaillée hautement qualitative de fibre de verre. Surface du luminaire et réflecteur/bague décorative disponible en différentes combinaisons et couleurs au choix, Ex: blanc, argent, graphite, noir, or ou cuivre. Pour les options et combinaisons de finitions, voir Lightnet Surface Collection ou Bi-Colour Selection. Diffuseur microprismatique optimisé pour un éblouissement limité et adapté aux bureaux. Diffuseur opale satiné pour un éclairage général et une transmission maximale et homogène. Driver intégré dans le luminaire, au choix ON/OFF ou graduable (1-10V, DALI, Touch-Dim, Casambi). Température de couleur 2200K, 2700K, 3000K, 3500K, 4000K ou 6500K. Binning initial  $\leq$  MacAdam 3. Rendu de couleur CRI>80 ou CRI>90.

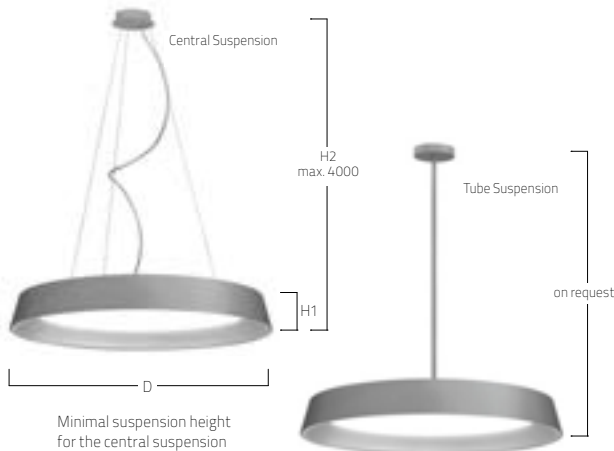

Minimal suspension height for the central suspension

D [mm]	H1 [mm]	H2 [mm]
450	60	350
700	85	600
1100	125	1000

**PRODUCT-CODE: MP3 O A D - 8 30 M - D450 - UG**

PRODUCT FAMILY	- M: Beam Me Up
TYPE	- P3: Direct-Indirect, G3: Direct Only
OPTICAL SYSTEM	- A: Microprismatic, O: Opal
SURFACE FINISH	- W: Snow White, V: Ivory White, A: Satin Silver, U: Urban Graphite, B: Jet Black, H: Champagne Silver, K: Satin Copper
CONTROL GEAR	- E: On/Off, L: DALI, D: 1-10V, H: Touch-Dim, C: Casambi
COLOUR REND.	- 8: CRI>80, 9: CRI>90
COLOUR TEMP.	- 22: 2200K, 27: 2700K, 30: 3000K, 35: 3500K, 40: 4000K, 65: 6500K, TW: Tunable White 2700-6500K
POWER	- M: Medium Power, H: High Power
SIZE	- Luminaire Diameter in mm: D450, D700, D1100
SUSPENSION	- U: Central Suspension, P: Tube Suspension (max D700), K: Parallel Suspension
REFLECTOR	- W: Snow White, V: Ivory White, A: Satin Silver, U: Urban Graphite, B: Jet Black, H: Champagne Silver, K: Satin Copper, G: Satin Gold
ON REQUEST	- Radar Sensor, Emergency Module, Cable Colour: Black, Red



MICROPRISMATIC / DIRECT-INDIRECT

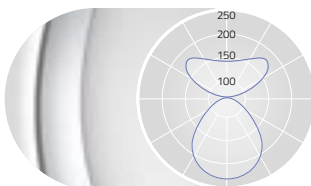

UGR<sub>s</sub>19 (X=4H, Y=8H, S=0.25H)  
DIRECT: ca.50% INDIRECT ca.50%

MICROPRISMATIC / DIRECT



UGR<sub>s</sub>19 for Medium Power (X=4H, Y=8H, S=0.25H)  
DIRECT: 100%

OPAL DIFFUSER / DIRECT-INDIRECT

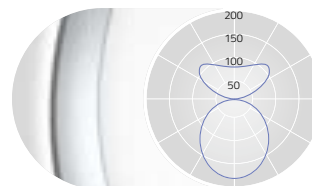

DIRECT: ca.50% INDIRECT ca.50%

OPAL DIFFUSER / DIRECT



DIRECT: 100%

D mm	Lumen/Watt Medium Power	Lumen/Watt High Power
450	3160lm/23W	5040lm/37W
700	6090lm/41W	9830lm/68W
1100	14030lm/120W	19730lm/177W

D mm	Lumen/Watt Medium Power	Lumen/Watt High Power
450	1630lm/12W	2650lm/19W
700	3820lm/25W	6320lm/42W
1100	5840lm/68W	8580lm/104W

D mm	Lumen/Watt Medium Power	Lumen/Watt High Power
450	3170lm/23W	5050lm/37W
700	6210lm/41W	9950lm/68W
1100	14300lm/120W	20130lm/177W

D mm	Lumen/Watt Medium Power	Lumen/Watt High Power
450	1640lm/12W	2660lm/19W
700	3940lm/25W	6440lm/42W
1100	6110lm/68W	8980lm/104W



# BEAM ME UP SUSPENDED



GSP ARCHITEKTEN, BREMEN, GERMANY  
BEAM ME UP-P1



GROSSRAUMBÜRO, SCHÖNBÜHL, SWITZERLAND  
BEAM ME UP-P1  
ERGÄNZEN; REALIZATION: MABALUX AG

# BEAM ME UP SUSPENDED



BERTSCHI AG, DÜRRENÄSCH, SWITZERLAND  
BEAM ME UP-P1  
REALIZATION: MABALUX AG





BEAM ME UP  
SUSPENDED | G1/P1



**DE** LED-Pendelleuchte mit rückversetzter Optik und dekorativem Reflektorring. Direkt-indirekt oder rein direktstrahlend. Leuchtschirm aus hochwertig verarbeitetem, glasfaserverstärktem Kunststoff (Fiberglas). Gehäuse-Außenfläche und dekorativer Reflektorring in unterschiedlichen Lackierungen und Kombinationen erhältlich, z.B. weiß, silber, graphit, schwarz, gold oder kupferfarben lackiert. Zu Oberflächenoptionen- und Kombinationen siehe Lightnet-Surface-Collection oder Bi-Colour-Auswahl. Microprismenoptik mit optimierter Blendungsbegrenzung speziell für Office-Anwendungen. Satinierter Opaldiffusor für Allgemeinbeleuchtung mit max. Transmissionsgrad und homogener Lichtpunktauflösung. Converter in Leuchtgehäuse integriert, wahlweise einfach schaltbar oder stufenlos dimmbar (1-10V, DALI, Touch-Dim, Casambi). Farbtemperaturen 2200K, 2700K, 3000K, 3500K, 4000K oder 6500K. Binning initial  $\leq$  MacAdam 3. Farbwiedergabe CRI>80 oder CRI>90. Stufenlos höhenverstellbare Parallel-Seilabhängung mit transparent ummantelter Zuleitung.

**EN** LED pendant luminaire with a setback lens optic in a decorative ring. Direct-indirect or Direct Only light distribution. Luminaire body made of high-quality processed FRP (fiberglass reinforced plastic). Outer housing and decorative reflector ring available in various finishes and combinations, e.g. white, silver, graphite, black, gold or copper coated. For surface options and combinations check Lightnet Surface Collection or Bi-Colour Selection. Microprismatic with optimized glare reduction especially for workplaces. Satin opal diffuser for general lighting with maximum transmittance and homogeneous lighting. Converter integrated into luminaire housing, optionally switchable or dimmable (1-10V, DALI, Touch-Dim, Casambi). Colour temperatures 2200K, 2700K, 3000K, 3500K, 4000K or 6500K. Binning initial  $\leq$  MacAdam 3. Colour rendering CRI>80 or CRI>90. Height-adjustable parallel-cord suspension with transparent power supply cable.

**FR** Luminaire LED suspendu avec diffuseur/optique en retrait et bague décorative. Éclairage direct/indirect ou seulement direct. Abat-Jour en matière travaillée hautement qualitative de fibre de verre. Surface du luminaire et réflecteur/bague décorative disponible en différentes combinaisons et couleurs au choix, Ex: blanc, argent, graphite, noir, or ou cuivre. Pour les options et combinaisons de finitions, voir Lightnet Surface Collection ou Bi-Colour Selection. Diffuseur microprismatique optimisé pour un éblouissement limité et adapté aux bureaux. Diffuseur opale satiné pour un éclairage général et une transmission maximale et homogène. Driver intégré dans le luminaire, au choix ON/OFF ou graduable (1-10V, DALI, Touch-Dim, Casambi). Température de couleur 2200K, 2700K, 3000K, 3500K, 4000K ou 6500K. Binning initial  $\leq$  MacAdam 3. Rendu de couleur CRI>80 ou CRI>90. Filin parallèle droit et tendeur rapide réglable avec câble d'alimentation transparent.

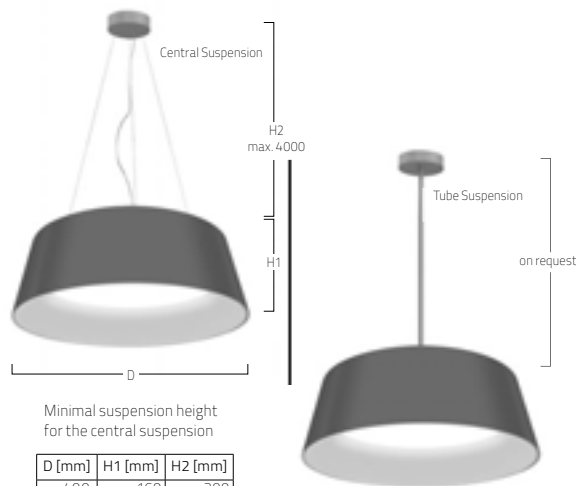

Minimal suspension height for the central suspension

D [mm]	H1 [mm]	H2 [mm]
400	160	300
700	250	600
1200	350	1100

**PRODUCT-CODE: M P 1 O A D - 8 3 0 M - D700 - U G**

- PRODUCT FAMILY — **M**: Beam Me Up
- TYPE — **P1**: Direct-Indirect, **G1**: Direct Only
- OPTICAL SYSTEM — **A**: Microprismatic, **O**: Opal
- SURFACE FINISH — **W**: Snow White, **V**: Ivory White, **A**: Satin Silver, **U**: Urban Graphite, **B**: Jet Black, **H**: Champagne Silver, **K**: Satin Copper
- CONTROL GEAR — **E**: On/Off, **L**: DALI, **D**: 1-10V, **H**: Touch-Dim, **C**: Casambi
- COLOUR REND. — **8**: CRI>80, **9**: CRI>90, **F**: Full Spectrum
- COLOUR TEMP. — **22**: 2200K, **27**: 2700K, **30**: 3000K, **35**: 3500K, **40**: 4000K, **65**: 6500K, **TW**: Tunable White 2700-6500K
- POWER — **M**: Medium Power, **H**: High Power
- SIZE — Luminaire Diameter in mm: **D400**, **D700**, **D1200**
- SUSPENSION — **U**: Central Suspension, **P**: Tube Suspension [max D700] **K**: Parallel Suspension
- REFLECTOR — **W**: Snow White, **V**: Ivory White, **A**: Satin Silver, **U**: Urban Graphite, **B**: Jet Black, **H**: Champagne Silver, **K**: Satin Copper, **G**: Satin Gold
- ON REQUEST — Radar Sensor, Emergency Module, Cable Colour: Black, Red



MICROPRISMATIC / DIRECT-INDIRECT



UGR $\leq$ 16 (X=4H, Y=8H, S=0.25H)  
DIRECT: ca.50% INDIRECT ca.50%

MICROPRISMATIC / DIRECT



UGR $\leq$ 19 for Medium Power (X=4H, Y=8H, S=0.25H)  
DIRECT: 100%

OPAL DIFFUSER / DIRECT-INDIRECT



DIRECT: ca.50% INDIRECT ca.50%

OPAL DIFFUSER / DIRECT

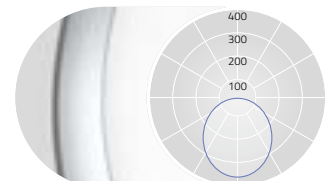

DIRECT: 100%

D mm	Lumen/Watt Medium Power	Lumen/Watt High Power
400	2180lm/20W	3190lm/32W
700	5860lm/50W	8590lm/80W
1200	19730lm/177W	27150lm/247W

D mm	Lumen/Watt Medium Power	Lumen/Watt High Power
400	1090lm/14W	1600lm/22W
700	2920lm/35W	4290lm/52W
1200	8580lm/104W	11220lm/139W

D mm	Lumen/Watt Medium Power	Lumen/Watt High Power
400	2230lm/20W	3270lm/32W
700	6000lm/50W	8790lm/80W
1200	20130lm/177W	27680lm/247W

D mm	Lumen/Watt Medium Power	Lumen/Watt High Power
400	1140lm/14W	1680lm/22W
700	3060lm/35W	4490lm/52W
1200	8980lm/104W	11750lm/139W



# RINGO STAR SUSPENDED

DOMINIKANEN KERK, MAASTRICHT, NETHERLANDS  
RINGO STAR-P3-SPOTLIGHT  
PHOTOS: SERGE TECHNAU  
LIGHT PLANNING: GREASELIGHTING

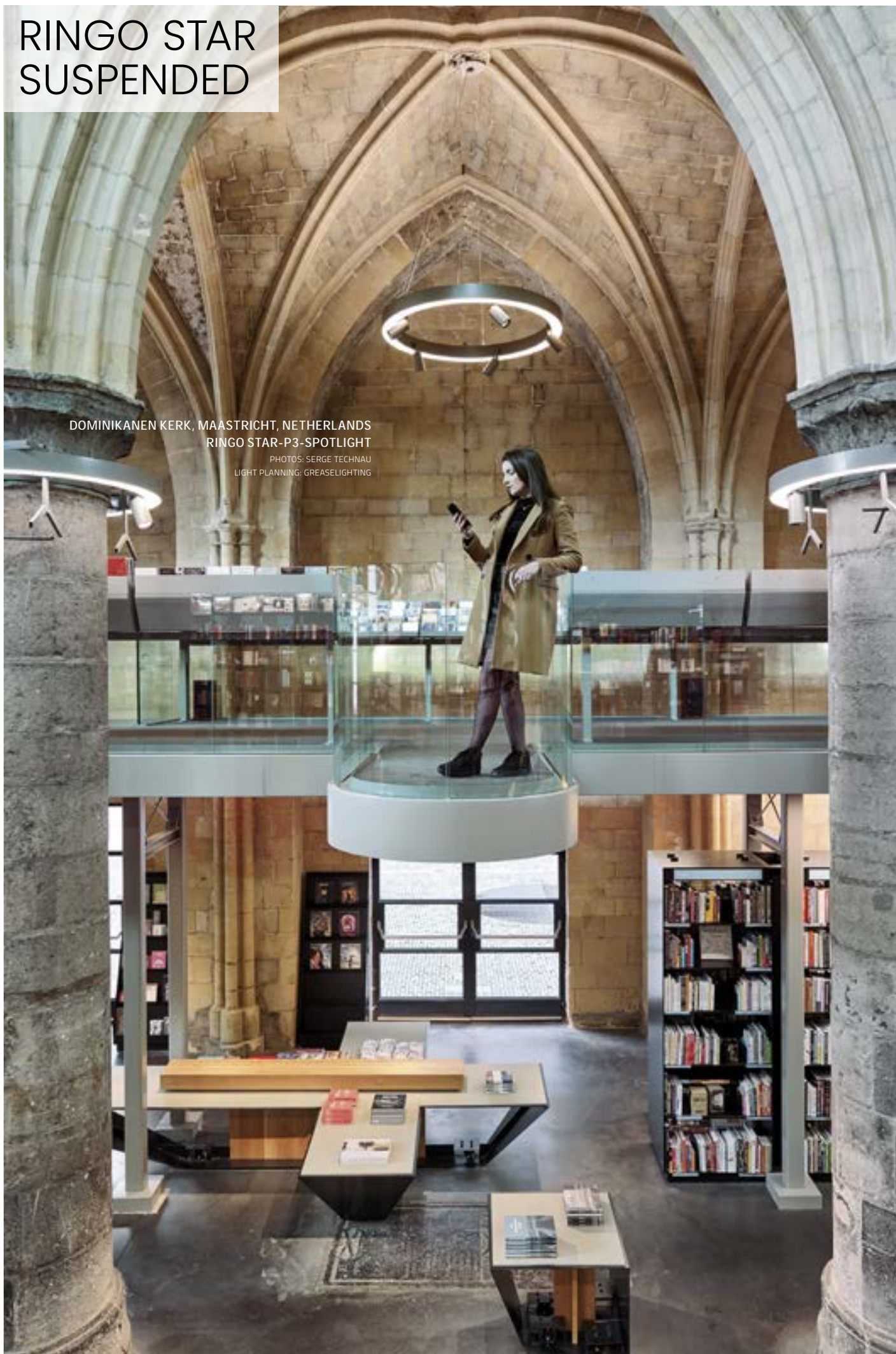

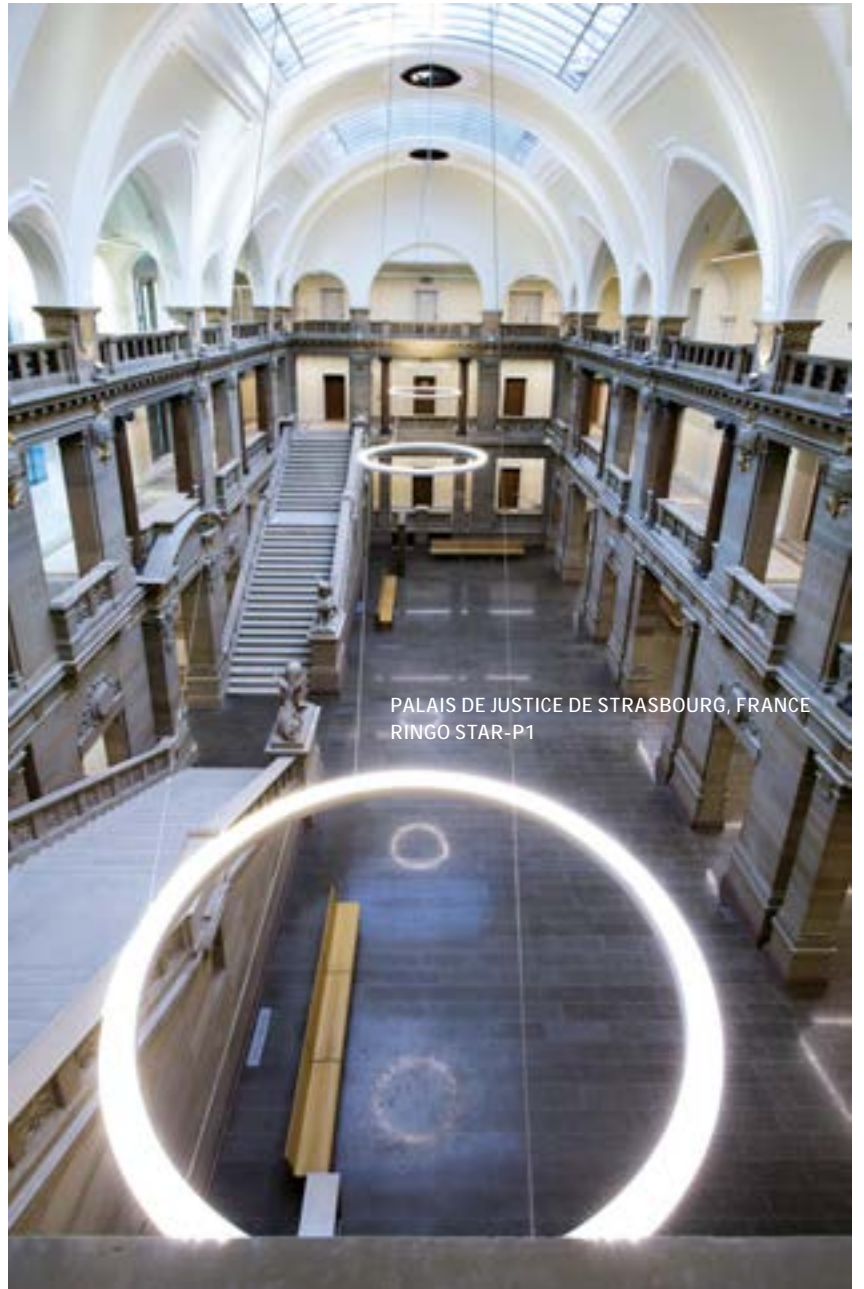

# RINGO STAR SUSPENDED

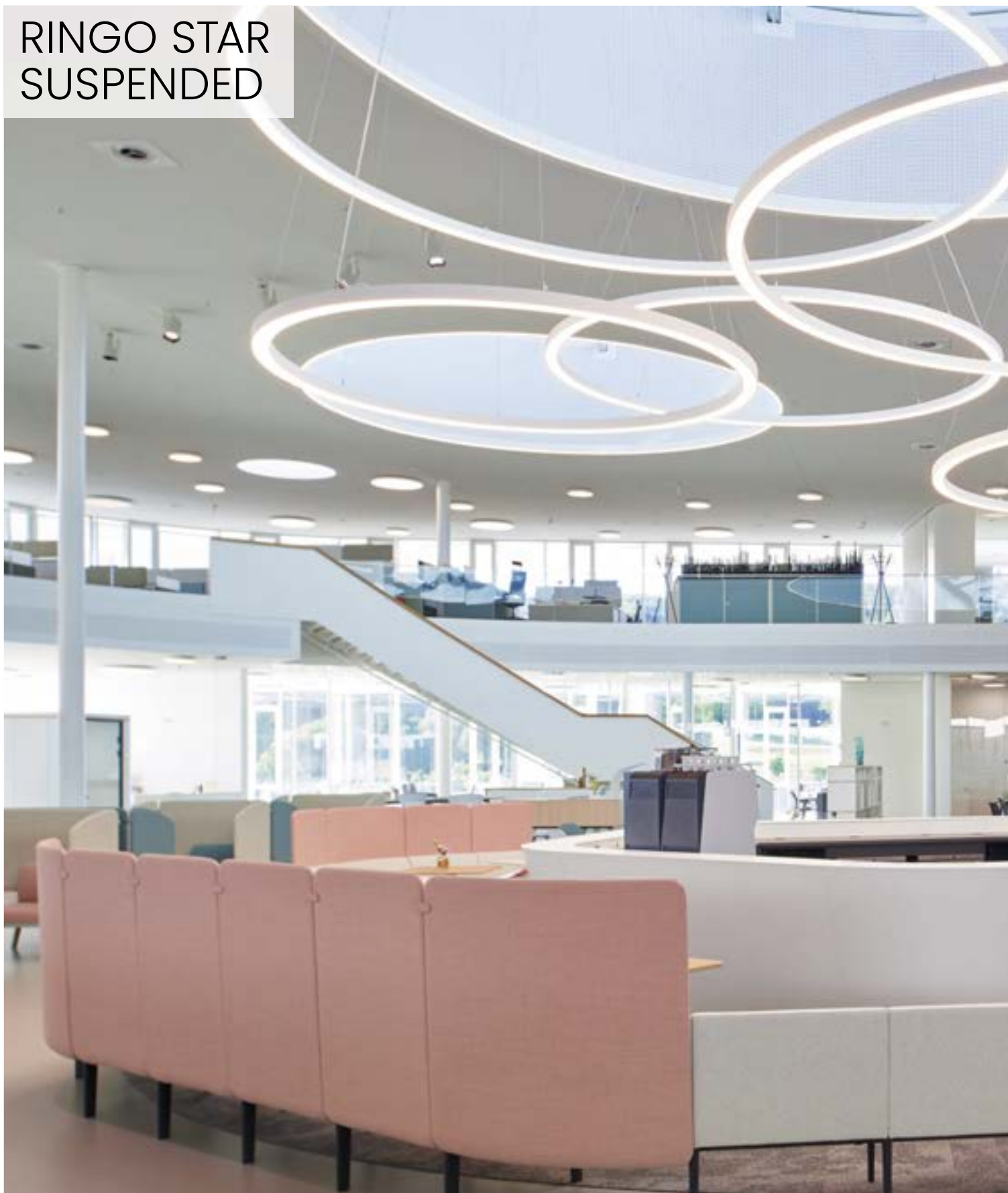



SEDUS SMART OFFICE, DOGERN, GERMANY  
RINGO STAR-G1

# RINGO STAR SUSPENDED



LANDTAG MECKLENBURG-VORPOMMERN, SCHWERIN, GERMANY  
RINGO STAR-P1  
PHOTOS: JENS PASSOTH





# RINGO STAR SUSPENDED





SYDNEY AIRPORT, AUSTRALIA  
RINGO STAR - G1

# RINGO STAR SUSPENDED



DEPETRUS KERK, VUGHT, NETHERLANDS  
RINGO STAR-P1-SPOTLIGHT  
LIGHT PLANNING: POP LIGHT B.V.



# RINGO STAR SUSPENDED

CUSTOM HOUSE, GREENOCK, UK  
RINGO STAR-P1



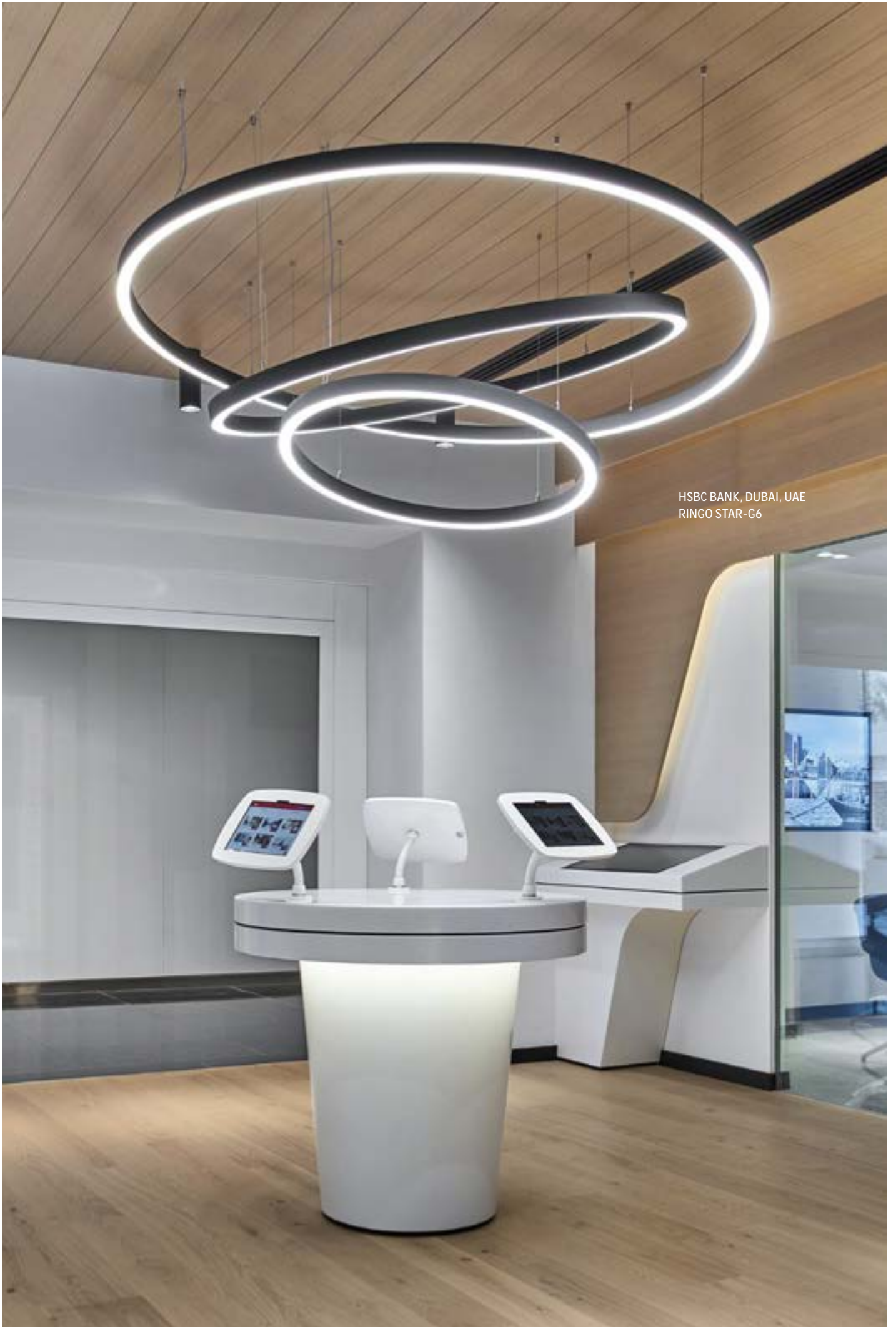

HSBC BANK, DUBAI, UAE  
RINGO STAR-G6

# RINGO STAR SUSPENDED



AURORA BUILDING, GLASGOW, UK  
RINGO STAR-P1



KANTINE BAYER, WUPPERTAL, GERMANY  
RINGO STAR-P1



# RINGO STAR SUSPENDED



FINANCIAL HUB, COLUMBUS, USA  
RINGO STAR-G3

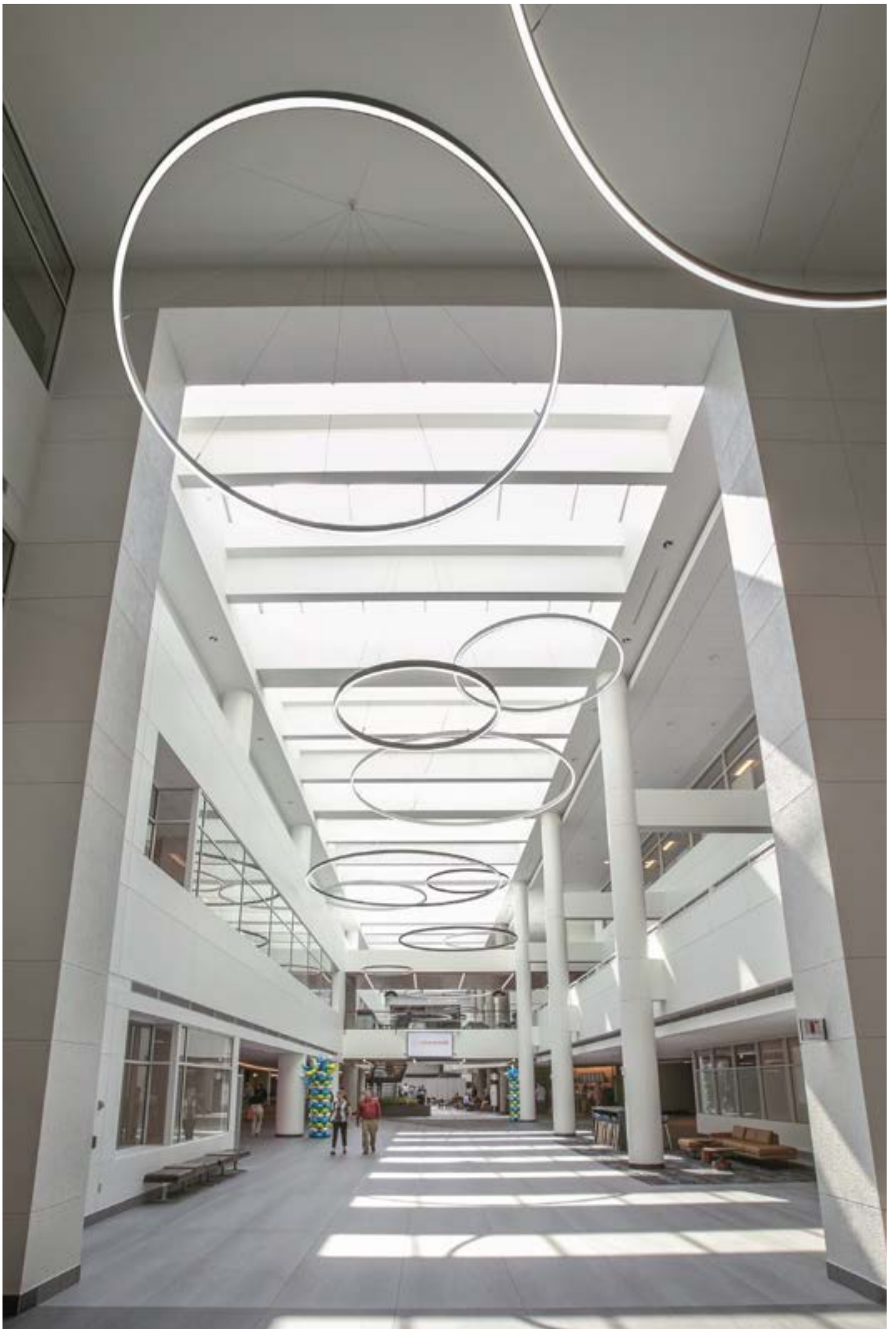

RINGO STAR 38MM  
SUSPENDED | G6/P6



**DE** LED-Pendelleuchte. Direkt-indirekt oder rein direktstrahlend. Leuchtenkörper aus Aluminiumprofil mit 38mm Lichtspurbreite. 6 verschiedene Durchmesser von 1000mm bis 3500mm. Oberfläche silber, weiß, graphit, schwarz, champagner oder kupferfarben lackiert. Weitere Oberflächenoptionen siehe Lightnet-Surface-Collection oder RAL nach Wahl. Silikon Opaldiffusor für Allgemeinbeleuchtung mit max. Transmissionsgrad und homogener Lichtpunktauflösung. Konverter im Deckenbaldachin integriert, wahlweise einfach schaltbar oder stufenlos dimmbar (DALI, Touch-Dim, Casambi). Farbtemperaturen 2200K, 2700K, 3000K, 3500K, 4000K oder 6500K. Binning initial  $\leq$  MacAdam 3. Colour rendering CRI>80 oder CRI>90. Stufenlos höhenverstellbare Zentral-Seilabhängung oder Parallel-Seilabhängung mit transparent ummantelter Zuleitung.

**EN** LED pendant luminaire. Direct-indirect or Direct Only light distribution. Luminaire body made of aluminium profile with 38mm track width. 6 different diameters from 1000mm to 3500mm. Surface silver, white, graphite, black, champagne or copper coated. Further surface options see Lightnet-Surface-Collection or RAL of your choice. Silicone opal diffuser for general lighting with maximum transmittance and homogeneous lighting. Converter integrated in ceiling rose, optionally switchable or dimmable (DALI, Touch-Dim, Casambi). Colour temperatures 2200K, 2700K, 3000K, 3500K, 4000K or 6500K. Binning initial  $\leq$  MacAdam 3. Colour rendering CRI>80 or CRI>90. Height-adjustable central cord suspension or parallel-cord suspension with transparent power supply cable.

**FR** Luminaire LED suspendu. Éclairage direct/indirect ou seulement direct. Corps du luminaire en profilé aluminium avec 38mm de largeur du spèctre lumineux. 6 diamètres différents de 1000mm à 3500mm. Surface laquée argent, blanc, graphite, noir, champagne ou cuivre. Autres options de finition voir Lightnet-Surface-Collection ou RAL au choix. Diffuseur opale en silicone pour un éclairage général et une transmission maximale et homogène. Driver intégré dans la patère, ON/OFF ou réglable au choix (DALI, Touch-Dim, Casambi). Température de couleur 2200K, 2700K, 3000K, 3500K, 4000K ou 6500K. Binning initial  $\leq$  MacAdam 3. Rendu de couleur CRI>80 ou CRI>90. Suspension centrale ou parallèle réglable en hauteur avec câble d'alimentation transparent.

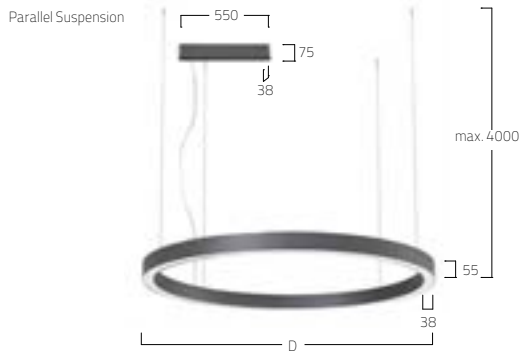

Minimal suspension height for central suspension

D [mm]	H [mm]
600	500
900	700
1200	1000
1500	1500
2000	2000

**PRODUCT-CODE:** R P6 O S L - 8 30 M - D1500 - U

PRODUCT FAMILY	- R: Ringo Star
TYPE	- P6: Direct-Indirect, G6: Direct Only
OPTICAL SYSTEM	- O: Opal
SURFACE FINISH	- W: Snow White, V: Ivory White, S: Radiant Silver, U: Urban Graphite, B: Jet Black, H: Champagne Silver, K: Satin Copper
CONTROL GEAR	- E: On/Off, L: DALI, H: Touch-Dim, U: Separately Dimmable DALI
COLOUR REND.	- 8: CRI>80, 9: CRI>90, F: Full Spectrum
COLOUR TEMP.	- 22: 2200K, 27: 2700K, 30: 3000K, 35: 3500K, 40: 4000K, 65: 6500K
POWER	- M: Medium Power
SIZE	- Luminaire Diameter in mm: D600, D900, D1200, D1500, D2000, D2500, 3000, D3500
SUSPENSION	- U: Central Suspension [max. D2000], K: Parallel Suspension
ON REQUEST	- Cable Colour: Black, Red, Casambi



OPAL DIFFUSER / DIRECT-INDIRECT

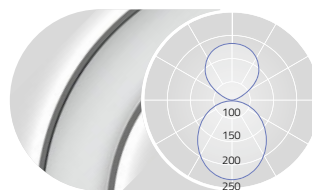

DIRECT: ca.55% INDIRECT ca.45%

OPAL DIFFUSER / DIRECT

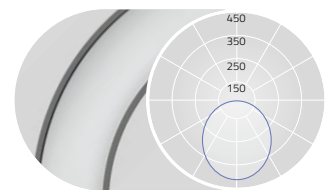

DIRECT: 100%

D mm	Lumen/Watt Medium Power
600	5430lm/44W
900	8690lm/70W
1200	11020lm/89W
1500	14400lm/117W
2000	18190lm/148W
2500	23450lm/190W
3000	28200lm/227W
3500	32670lm/268W

D mm	Lumen/Watt Medium Power
600	3070lm/27W
900	4760lm/42W
1200	6260lm/55W
1500	7910lm/70W
2000	10500lm/93W
2500	13130lm/116W
3000	15760lm/138W
3500	18380lm/161W

Lumen Values: Luminaire luminous flux at 4000K/CRI>80. Other configurations on request.



RINGO STAR 60MM  
SUSPENDED | G3/P3



**DE** LED-Pendelleuchte. Direkt-indirekt oder rein direktstrahlend. Leuchtenkörper aus Aluminiumprofil mit 60mm Lichtspurbreite. 13 verschiedene Durchmesser von 600mm bis 8000mm. Oberfläche silber, weiß, graphit, schwarz, champagner oder kupferfarben lackiert. Weitere Oberflächenoptionen siehe Lightnet-Surface-Collection oder RAL nach Wahl. Microprismenoptik mit optimierter Blendungsbegrenzung speziell für Office-Anwendungen. Satinierter Opaldiffusor für Allgemeinbeleuchtung mit max. Transmissionsgrad und homogener Lichtpunktauflösung. Konverter in Leuchtgehäuse integriert, wahlweise einfach schaltbar oder stufenlos dimmbar (1-10V, DALI, Touch-Dim, Casambi). Farbtemperaturen 2200K, 2700K, 3000K, 3500K, 4000K oder 6500K. Binning initial  $\leq$  MacAdam 3. Farbwiedergabe CRI>80 oder CRI>90. Stufenlos höhenverstellbare Zentral-Seilabhangung oder Parallel-Seilabhangung mit transparent ummantelter Zuleitung.

**EN** LED pendant luminaire. Direct-indirect or direct-only light distribution. Luminaire body made of aluminium profile with 60mm track width. 13 different diameters from 600mm to 8000mm. Surface silver, white, graphite, black, champagne or copper coated. Further surface options see Lightnet-Surface-Collection or RAL of your choice. Microprismatic with optimized glare reduction especially for workplaces. Satin opal diffuser for general lighting with maximum transmittance and homogeneous lighting. Converter integrated into luminaire housing, optionally switchable or dimmable (1-10V, DALI, Touch-Dim, Casambi). Colour temperatures 2200K, 2700K, 3000K, 3500K, 4000K or 6500K. Binning initial  $\leq$  MacAdam 3. Colour rendering CRI>80 or CRI>90. Height-adjustable Central Suspension or parallel-cord suspension with transparent power supply cable.

**FR** Luminaire LED suspendu. clairage direct/indirect ou seulement direct. Corps du luminaire en profil aluminium avec 60mm de largeur du spectre lumineux. 13 diametres differents de 600mm  8000mm. Surface laquee argent, blanc, graphite, noir, champagne ou cuivre. Autres options de finition voir Lightnet-Surface-Collection ou RAL au choix. Diffuseur microprismatique optimise pour un blouissement limite et adapte aux bureaux. Diffuseur opale satine pour un clairage general et une transmission maximale et homogene. Driver integre dans le luminaire, au choix ON/OFF ou graduable (1-10V, DALI, Touch-Dim, Casambi). Temperature de couleur 2200K, 2700K, 3000K, 3500K, 4000K ou 6500K. Binning initial  $\leq$  MacAdam 3. Rendu de couleur CRI>80 ou CRI>90. Suspension centrale ou parallelle reglable en hauteur avec cable d'alimentation transparent.

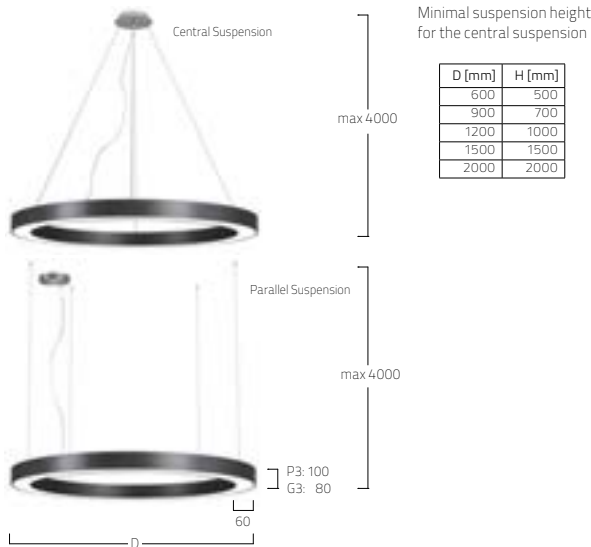

**PRODUCT-CODE:** R P3 O S D - 8 30 M - D1500 - U

- PRODUCT FAMILY - R: Ringo Star
- TYPE - P3: Direct-Indirect, G3: Direct Only
- OPTICAL SYSTEM - O: Opal, A: Microprismatic
- SURFACE FINISH - W: Snow White, V: Ivory White, S: Radiant Silver, U: Urban Graphite, B: Jet Black, H: Champagne Silver, K: Satin Copper
- CONTROL GEAR - E: On/Off, L: DALI, D: 1-10V, H: Touch-Dim, C: Casambi, U: Separately Dimmable DALI
- COLOUR REND. - 8: CRI>80, 9: CRI>90, F: Full Spectrum
- COLOUR TEMP. - 22: 2200K, 27: 2700K, 30: 3000K, 35: 3500K, 40: 4000K, 65: 6500K, TW: Tunable White 2700-6500K
- POWER - M: Medium Power, H: High Power
- SIZE - Luminaire Diameter in mm: D600, D900, D1200, D1500, D2000, D2500, D3000, D3500, D4000, D5000, D6000, D7000, D8000
- SUSPENSION - U: Central Suspension [max D2000], K: Parallel Suspension
- ON REQUEST - Emergency Module, Cable Colour: Black, Red

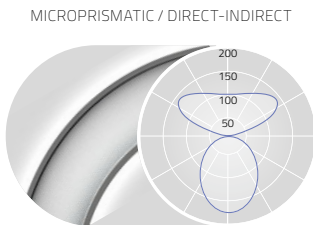

UGR $\leq$ 19 for Medium Power (X=4H, Y=BH, S=0.25H)  
DIRECT: ca.40% INDIRECT ca.60%

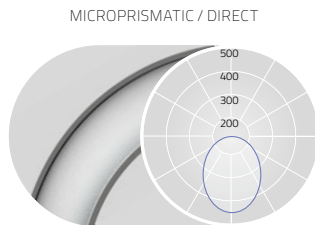

DIRECT: 100%

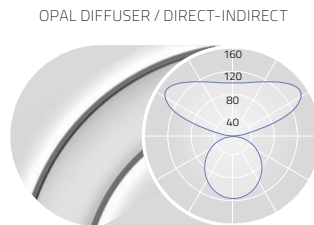

DIRECT: ca.35% INDIRECT ca.65%

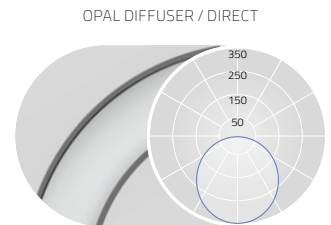

DIRECT: 100%

D mm	Lumen/Watt Medium Power
600	5790lm/63W
900	10250lm/103W
1200	14630lm/145W
1500	21060lm/207W
2000	23430lm/193W
2500	29710lm/245W
3000	35980lm/296W
3500	46030lm/372W
4000	46860lm/381W
5000	59410lm/483W
6000	71960lm/585W
7000	82850lm/670W
8000	102940lm/824W

D mm	Lumen/Watt Medium Power	Lumen/Watt High Power
600	2480lm/25W	3750lm/38W
900	4100lm/39W	5620lm/55W
1200	5320lm/50W	7210lm/70W
1500	7090lm/66W	9620lm/92W
2000	8340lm/87W	12200lm/132W
2500	10840lm/112W	15860lm/172W
3000	13340lm/137W	19520lm/207W
3500	15850lm/162W	23180lm/248W
4000	16680lm/171W	24400lm/259W
5000	21680lm/221W	31720lm/340W
6000	26690lm/272W	39040lm/414W
7000	30020lm/305W	43920lm/466W
8000	35030lm/355W	51240lm/547W

D mm	Lumen/Watt Medium Power
600	5370lm/63W
900	9560lm/103W
1200	13730lm/145W
1500	19860lm/207W
2000	22060lm/193W
2500	27930lm/245W
3000	33790lm/296W
3500	43430lm/372W
4000	44130lm/381W
5000	55860lm/483W
6000	67590lm/585W
7000	77920lm/670W
8000	97200lm/824W

D mm	Lumen/Watt Medium Power	Lumen/Watt High Power
600	2060lm/25W	3110lm/38W
900	3410lm/39W	4670lm/55W
1200	4420lm/50W	5990lm/70W
1500	5890lm/66W	7990lm/92W
2000	6970lm/87W	10200lm/132W
2500	9060lm/112W	13260lm/172W
3000	11160lm/137W	16320lm/207W
3500	13250lm/162W	19380lm/248W
4000	13950lm/171W	20400lm/259W
5000	18130lm/221W	26520lm/340W
6000	22310lm/272W	32640lm/414W
7000	25100lm/305W	36720lm/466W
8000	29290lm/355W	42840lm/547W

Lumen Values: Luminaire luminous flux at 4000K/CRI>80 / surface finished Snow White. Other configurations on request.



RINGO STAR 100MM  
SUSPENDED | G1/P1



**DE** LED-Pendelleuchte. Direkt-indirekt oder rein direktstrahlend. Leuchtenkörper aus Aluminiumprofil mit 100mm Lichtspurbreite. 13 verschiedene Durchmesser von 600mm bis 8000mm. Oberfläche silber, weiß, graphit, schwarz, champagner oder kupferfarben lackiert. Weitere Oberflächenoptionen siehe Lightnet-Surface-Collection oder RAL nach Wahl. Microprismenoptik mit optimierter Blendungsbegrenzung speziell für Office-Anwendungen. Satinierter Opaldiffusor für Allgemeinbeleuchtung mit max. Transmissionsgrad und homogener Lichtpunktauflösung. Konverter in Leuchtgehäuse integriert, wahlweise einfach schaltbar oder stufenlos dimmbar (1-10V, DALI, Touch-Dim, Casambi). Farbtemperaturen 2200K, 2700K, 3000K, 3500K, 4000K oder 6500K. Binning initial  $\leq$  MacAdam 3. Colour rendering CRI>80 oder CRI>90. Stufenlos höhenverstellbare Zentral-Seilabhangung oder Parallel-Seilabhangung mit transparent ummantelter Zuleitung.

**EN** LED pendant luminaire. Direct-indirect or Direct Only light distribution. Luminaire body made of aluminium profile with 100mm track width. 13 different diameters from 600mm to 8000mm. Surface silver, white, graphite, black, champagne or copper coated. Further surface options see Lightnet-Surface-Collection or RAL of your choice. Microprismatic with optimized glare reduction especially for workplaces. Satin opal diffuser for general lighting with maximum transmittance and homogeneous lighting. Converter integrated into luminaire housing, optionally switchable or dimmable (1-10V, DALI, Touch-Dim, Casambi). Colour temperatures 2200K, 2700K, 3000K, 3500K, 4000K or 6500K. Binning initial  $\leq$  MacAdam 3. Colour rendering CRI>80 or CRI>90. Height-adjustable central cord suspension or parallel-cord suspension with transparent power supply cable.

**FR** Luminaire LED suspendu. Éclairage direct/indirect ou seulement direct. Corps du luminaire en profilé aluminium avec 100mm de largeur du spèctre lumineux. 13 diamètres différents de 600mm à 8000mm. Surface laquée argent, blanc, graphite, noir, champagne ou cuivre. Autres options de finition voir Lightnet-Surface-Collection ou RAL au choix. Diffuseur microprismatique optimisé pour un éblouissement limité et adapté aux bureaux. Diffuseur opale satiné pour un éclairage général et une transmission maximale et homogène. Driver intégré dans le luminaire, au choix ON/OFF ou graduable (1-10V, DALI, Touch-Dim, Casambi). Température de couleur 2200K, 2700K, 3000K, 3500K, 4000K ou 6500K. Binning initial  $\leq$  MacAdam 3. Rendu de couleur CRI>80 ou CRI>90. Suspension centrale ou parallèle réglable en hauteur avec câble d'alimentation transparent.



Minimal suspension height for the central suspension

D [mm]	H [mm]
600	500
900	700
1200	1000
1500	1500
2000	2000

**PRODUCT-CODE:** R P1 O S D - 8 30 M - D1500 - U

PRODUCT FAMILY	- R: Ringo Star
TYPE	- P1: Direct-Indirect, G1: Direct Only
OPTICAL SYSTEM	- O: Opal, A: Microprismatic
SURFACE FINISH	- W: Snow White, V: Ivory White, S: Radiant Silver, U: Urban Graphite, B: Jet Black, H: Champagne Silver, K: Satin Copper
CONTROL GEAR	- E: On/Off, L: DALI, D: 1-10V, H: Touch-Dim, C: Casambi, U: Separately Dimmable DALI
COLOUR REND.	- 8: CRI>80, 9: CRI>90, F: Full Spectrum
COLOUR TEMP.	- 22: 2200K, 27: 2700K, 30: 3000K, 35: 3500K, 40: 4000K, 65: 6500K, TW: Tunable White 2700-6500K
POWER	- E: Low Power, M: Medium Power
SIZE	- Luminaire Diameter in mm: D600, D900, D1200, D1500, D2000, D2500, D3000, D3500, D4000, D5000, D6000, D7000, D8000
SUSPENSION	- U: Central Suspension [max D2000], K: Parallel Suspension
ON REQUEST	- Emergency Module, Cable Colour: Black, Red



MICROPRISMATIC / DIRECT-INDIRECT

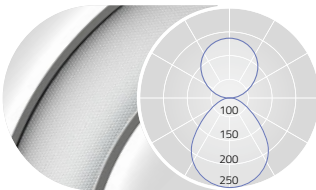

UGR<sub>s19</sub> for Low Power (X=4H, Y=8H, S=0.25H)  
DIRECT: ca.45% INDIRECT ca.55%

MICROPRISMATIC / DIRECT

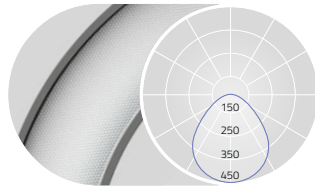

DIRECT: 100%

OPAL DIFFUSER / DIRECT-INDIRECT

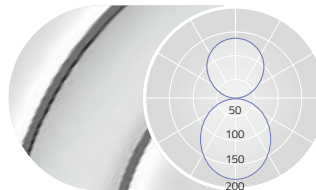

DIRECT: ca.40% INDIRECT ca.60%

OPAL DIFFUSER / DIRECT

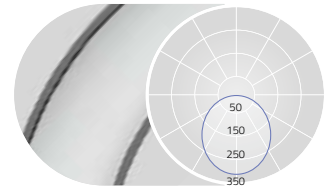

DIRECT: 100%

D mm	Lumen/Watt Low Power	Lumen/Watt Medium Power
600	6370lm/46W	9090lm/65W
900	10690lm/73W	14730lm/102W
1200	16130lm/106W	22260lm/148W
1500	20050lm/131W	27620lm/190W
2000	26730lm/171W	36830lm/247W
2500	30210lm/220W	45580lm/321W
3000	37840lm/260W	57200lm/397W
3500	40080lm/279W	60190lm/423W
4000	49140lm/350W	74180lm/519W
5000	59000lm/419W	88790lm/622W
6000	69980lm/482W	104880lm/730W
7000	88100lm/604W	132880lm/922W
8000	97400lm/674W	146740lm/1020W

D mm	Lumen/Watt Low Power	Lumen/Watt Medium Power
600	2600lm/25W	3560lm/35W
900	4140lm/39W	5580lm/54W
1200	6250lm/56W	8430lm/78W
1500	7770lm/70W	10450lm/102W
2000	10360lm/91W	13940lm/124W
2500	14510lm/124W	19410lm/156W
3000	17860lm/138W	23890lm/188W
3500	20090lm/157W	26870lm/214W
4000	23440lm/193W	31350lm/250W
5000	29020lm/225W	38810lm/307W
6000	35710lm/275W	47770lm/375W
7000	42410lm/329W	56730lm/448W
8000	47430lm/372W	63450lm/500W

D mm	Lumen/Watt Low Power	Lumen/Watt Medium Power
600	6460lm/46W	9220lm/65W
900	10840lm/73W	14930lm/102W
1200	16340lm/106W	22550lm/148W
1500	20320lm/131W	27990lm/190W
2000	27090lm/171W	37320lm/247W
2500	28210lm/220W	42900lm/321W
3000	35380lm/260W	53900lm/397W
3500	37300lm/279W	56470lm/423W
4000	45900lm/350W	69850lm/519W
5000	54990lm/419W	83420lm/622W
6000	65040lm/482W	98280lm/730W
7000	82230lm/604W	125040lm/922W
8000	90840lm/674W	137960lm/1020W

D mm	Lumen/Watt Low Power	Lumen/Watt Medium Power
600	2690lm/25W	3680lm/35W
900	4290lm/39W	5770lm/54W
1200	6470lm/56W	8720lm/78W
1500	8040lm/70W	10820lm/102W
2000	10710lm/91W	14420lm/124W
2500	12500lm/124W	16720lm/156W
3000	15390lm/138W	20580lm/188W
3500	17310lm/157W	23160lm/214W
4000	20200lm/193W	27020lm/250W
5000	25010lm/225W	33450lm/307W
6000	30780lm/275W	41170lm/375W
7000	36550lm/329W	48890lm/448W
8000	40880lm/372W	54670lm/500W

Lumen Values: Luminaire luminous flux at 4000K/CRI>80 / surface finished Snow White. Other configurations on request.





RINGO STAR 60MM ACOUSTIC  
SUSPENDED | G3/P3



**DE** LED-Akustik-Pendelleuchte. Direkt-indirekt oder rein direktstrahlend. Leuchtenkörper aus Aluminiumprofil mit 60mm Lichtspurbreite. 5 verschiedene Durchmesser von 600mm bis 2000mm. Oberfläche silber, weiß, graphit, schwarz, champagner oder kupferfarben lackiert. Weitere Oberflächenoptionen siehe Lightnet-Surface-Collection oder RAL nach Wahl. Akustikelement wählbar aus 4 Varianten (Green Moss, Yellow Felt, Graphite Felt oder White Perforated). Microprismenoptik mit optimierter Blendungsbegrenzung speziell für Office-Anwendungen. Satinierter Opaldiffusor für Allgemeinbeleuchtung mit max. Transmissionsgrad und homogener Lichtpunktauflösung. Konverter in Leuchtgehäuse integriert, wahlweise einfach schaltbar oder stufenlos dimmbar (1-10V, DALI, Touch-Dim, Casambi). Farbtemperaturen 2200K, 2700K, 3000K, 3500K, 4000K oder 6500K. Binning initial  $\leq$  MacAdam 3. Farbwiedergabe CRI>80 oder CRI>90.

**EN** LED acoustic pendant luminaire. Direct-indirect or direct-only light distribution. Luminaire body made of aluminium profile with 60mm track width. 5 different diameters from 600mm to 2000mm. Surface silver, white, graphite, black, champagne or copper coated. Further surface options see Lightnet-Surface-Collection or RAL of your choice. Acoustic element in 4 options (Green Moss, Yellow Felt, Graphite Felt oder White Perforated). Microprismatic with optimized glare reduction especially for workplaces. Satin opal diffuser for general lighting with maximum transmittance and homogeneous lighting. Converter integrated into luminaire housing, optionally switchable or dimmable (1-10V, DALI, Touch-Dim, Casambi). Colour temperatures 2200K, 2700K, 3000K, 3500K, 4000K or 6500K. Binning initial  $\leq$  MacAdam 3. Colour rendering CRI>80 or CRI>90.

**FR** Luminaire LED suspendu acoustique. Éclairage direct/indirect ou seulement direct. Corps du luminaire en profilé aluminium avec 60mm de largeur du spectre lumineux. 5 diamètres différents de 600mm à 2000mm. Surface laquée argent, blanc, graphite, noir, champagne ou cuivre. Autres options de finition voir Lightnet-Surface-Collection ou RAL au choix. Élément acoustique en 4 options disponibles (Mousse verte, Yellow Felt, Graphite Felt ou blanc perforé). Diffuseur microprismatique optimisé pour un éblouissement limité et adapté aux bureaux. Diffuseur opale satiné pour un éclairage général et une transmission maximale et homogène. Driver intégré dans le luminaire, au choix ON/OFF ou graduable (1-10V, DALI, Touch-Dim, Casambi). Température de couleur 2200K, 2700K, 3000K, 3500K, 4000K ou 6500K. Binning initial  $\leq$  MacAdam 3. Rendu de couleur CRI>80 ou CRI>90.



**PRODUCT-CODE: R P3 O S D - 8 30 M - D1500 - U - AY**

- PRODUCT FAMILY - **R** Ringo Star
- TYPE - **P3** Direct-Indirect, **G3** Direct Only
- OPTICAL SYSTEM - **O** Opal, **A** Microprismatic
- SURFACE FINISH - **W** Snow White, **V** Ivory White, **S** Radiant Silver, **U** Urban Graphite, **B** Jet Black, **H** Champagne Silver, **K** Satin Copper
- CONTROL GEAR - **E** On/Off, **L** DALI, **D** 1-10V, **H** Touch-Dim, **C** Casambi, **U** Separately Dimmable DALI
- COLOUR REND. - **8** CRI>80, **9** CRI>90, **F** Full Spectrum
- COLOUR TEMP. - **22** 2200K, **27** 2700K, **30** 3000K, **35** 3500K, **40** 4000K, **65** 6500K, **TW** Tunable White 2700-6500K
- POWER - **M** Medium Power, **H** High Power
- SIZE - Luminaire Diameter in mm: **D600**, **D900**, **D1200**, **D1500**, **D2000**
- SUSPENSION - **U** Central Suspension, **K** Parallel Suspension
- ACOUSTIC ABSORB. - **AY** Yellow Felt [max D1200], **AG** Graphite Felt [max D1200], **AM** Green Moss, **AW** White Perforated
- ON REQUEST - Emergency Module, Cable Colour: Black, Red

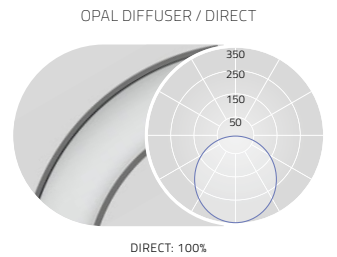
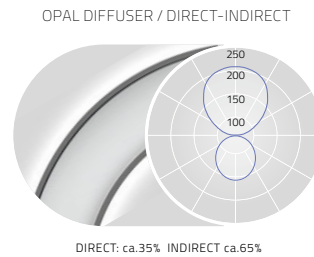
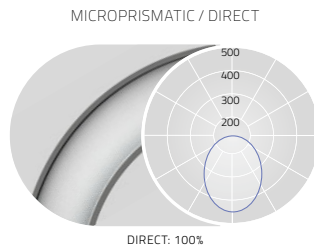
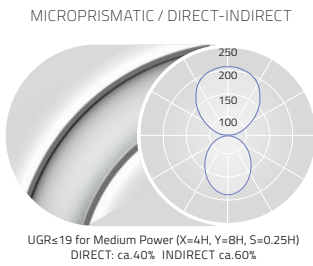
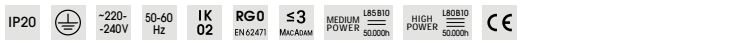

D mm	Lumen/Watt Medium Power
600	5700lm/48W
900	9640lm/80W
1200	13460lm/108W
1500	16910lm/137W
2000	22840lm/192W

D mm	Lumen/Watt Medium Power	Lumen/Watt High Power
600	2370lm/25W	3250lm/35W
900	3790lm/40W	4880lm/53W
1200	5280lm/54W	6580lm/69W
1500	6670lm/66W	8460lm/85W
2000	8900lm/89W	11660lm/118W

D mm	Lumen/Watt Medium Power
600	5310lm/48W
900	9020lm/80W
1200	12590lm/108W
1500	15820lm/137W
2000	21380lm/192W

D mm	Lumen/Watt Medium Power	Lumen/Watt High Power
600	1990lm/25W	2720lm/35W
900	3160lm/40W	4080lm/53W
1200	4420lm/54W	5500lm/69W
1500	5580lm/66W	7070lm/85W
2000	7440lm/89W	9750lm/118W

Lumen Values: Luminaire luminous flux at 4000K/CRI>80 / surface finished Snow White. Other configurations on request.

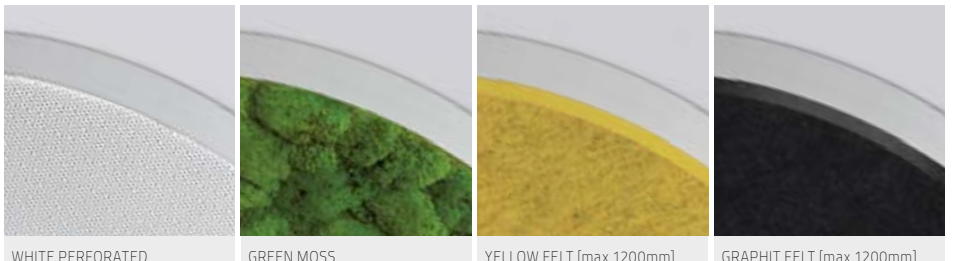

RINGO STAR 100<sub>MM</sub> ACOUSTIC  
SUSPENDED | G1/P1



**DE** LED-Akustik-Pendelleuchte. Direkt-indirekt oder rein direktstrahlend. Leuchtenkörper aus Aluminiumprofil mit 100mm Lichtspurbreite. 5 verschiedene Durchmesser von 600mm bis 2000mm. Oberfläche silber, weiß, graphit, schwarz, champagner oder kupferfarben lackiert. Weitere Oberflächenoptionen siehe Lightnet-Surface-Collection oder RAL nach Wahl. Akustikelement wählbar aus 4 Varianten (Green Moss, Yellow Felt, Graphite Felt oder White Perforated). Microprismenoptik mit optimierter Blendungsbegrenzung speziell für Office-Anwendungen. Satinierter Opaldiffusor für Allgemeinbeleuchtung mit max. Transmissionsgrad und homogener Lichtpunktauflösung. Konverter in Leuchtgehäuse integriert, wahlweise einfach schaltbar oder stufenlos dimmbar (1-10V, DALI, Touch-Dim, Casambi). Farbtemperaturen 2200K, 2700K, 3000K, 3500K, 4000K oder 6500K. Binning initial ≤ MacAdam 3. Farbwiedergabe CRI>80 oder CRI>90.

**EN** LED acoustic pendant luminaire. Direct-indirect or direct-only light distribution. Luminaire body made of aluminium profile with 100mm track width. 5 different diameters from 600mm to 2000mm. Surface silver, white, graphite, black, champagne or copper coated. Further surface options see Lightnet-Surface-Collection or RAL of your choice. Acoustic element in 4 options (Green Moss, Yellow Felt, Graphite Felt or White Perforated). Microprismatic with optimized glare reduction especially for workplaces. Satin opal diffuser for general lighting with maximum transmittance and homogeneous lighting. Converter integrated into luminaire housing, optionally switchable or dimmable (1-10V, DALI, Touch-Dim, Casambi). Colour temperatures 2200K, 2700K, 3000K, 3500K, 4000K or 6500K. Binning initial ≤ MacAdam 3. Colour rendering CRI>80 or CRI>90.

**FR** Luminaire LED suspendu acoustique. Éclairage direct/indirect ou seulement direct. Corps du luminaire en profilé aluminium avec 100mm de largeur du spectre lumineux. 5 diamètres différents de 600mm à 2000mm. Surface laquée argent, blanc, graphite, noir, champagne ou cuivre. Autres options de finition voir Lightnet-Surface-Collection ou RAL au choix. Élément acoustique en 4 options disponibles (Mousse verte, Yellow Felt, Graphite Felt ou blanc perforé). Diffuseur microprismatique optimisé pour un éblouissement limité et adapté aux bureaux. Diffuseur opale satiné pour un éclairage général et une transmission maximale et homogène. Driver intégré dans le luminaire, au choix ON/OFF ou graduable (1-10V, DALI, Touch-Dim, Casambi). Température de couleur 2200K, 2700K, 3000K, 3500K, 4000K ou 6500K. Binning initial ≤ MacAdam 3. Rendu de couleur CRI>80 ou CRI>90.

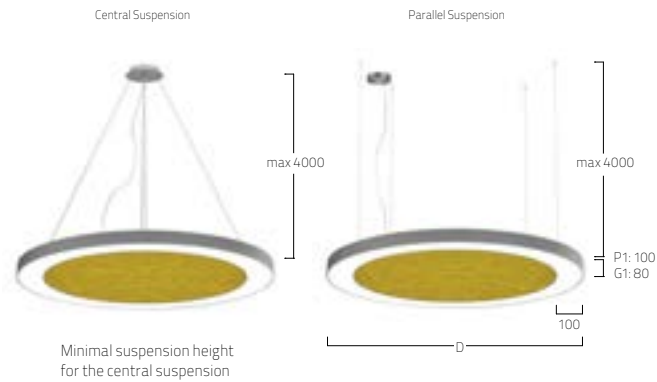

D [mm]	H [mm]
600	500
900	700
1200	1000
1500	1500
2000	2000

**PRODUCT-CODE:** R P1 O S D - 8 30 M - D1200 - U - AY

PRODUCT FAMILY	- R: Ringo Star
TYPE	- P1: Direct-Indirect, G1: Direct Only
OPTICAL SYSTEM	- O: Opal, A: Microprismatic
SURFACE FINISH	- W: Snow White, V: Ivory White, S: Radiant Silver, U: Urban Graphite, B: Jet Black, H: Champagne Silver, K: Satin Copper
CONTROL GEAR	- E: On/Off, L: DALI, D: 1-10V, H: Touch-Dim, C: Casambi, U: Separately Dimmable DALI
COLOUR REND.	- 8: CRI>80, 9: CRI>90, F: Full Spectrum
COLOUR TEMP.	- 22: 2200K, 27: 2700K, 30: 3000K, 35: 3500K, 40: 4000K, 65: 6500K, TW: Tunable White 2700-6500K
POWER	- E: Low Power, M: Medium Power
SIZE	- Luminaire Diameter in mm: D600, D900, D1200, D1500, D2000
SUSPENSION	- U: Central Suspension, K: Parallel Suspension
ACOUSTIC ABSORB.	- AY: Yellow Felt [max D1200], AG: Graphite Felt [max D1200], AM: Green Moss, AW: White Perforated
ON REQUEST	- Emergency Module, Cable Colour: Black, Red



MICROPRISMATIC / DIRECT-INDIRECT

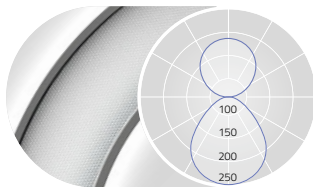

UGR<sub>19</sub> for Low Power (X=4H, Y=8H, S=0.25H)  
DIRECT: ca.40% INDIRECT ca.60%

D mm	Lumen/Watt Low Power	Lumen/Watt Medium Power
600	6370lm/46W	9090lm/65W
900	10690lm/73W	14730lm/102W
1200	16130lm/106W	22260lm/148W
1500	20050lm/131W	27620lm/190W
2000	26730lm/171W	36830lm/247W

MICROPRISMATIC / DIRECT

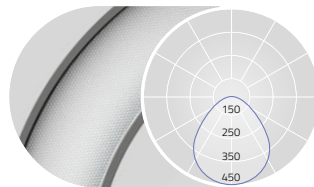

DIRECT: 100%

D mm	Lumen/Watt Low Power	Lumen/Watt Medium Power
600	2600lm/25W	3560lm/35W
900	4140lm/39W	5580lm/54W
1200	6250lm/56W	8430lm/78W
1500	7770lm/70W	10450lm/102W
2000	10360lm/91W	13940lm/124W

OPAL DIFFUSER / DIRECT-INDIRECT

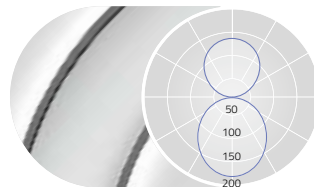

DIRECT: ca.55% INDIRECT ca.45%

D mm	Lumen/Watt Low Power	Lumen/Watt Medium Power
600	6460lm/46W	9220lm/65W
900	10840lm/73W	14930lm/102W
1200	16340lm/106W	22550lm/148W
1500	20320lm/131W	27990lm/190W
2000	27090lm/171W	37320lm/247W

OPAL DIFFUSER / DIRECT

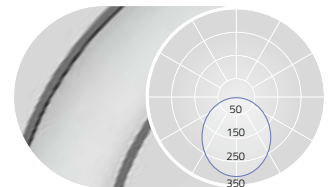

DIRECT: 100%

D mm	Lumen/Watt Low Power	Lumen/Watt Medium Power
600	2690lm/25W	3680lm/35W
900	4290lm/39W	5770lm/54W
1200	6470lm/56W	8720lm/78W
1500	8040lm/70W	10820lm/102W
2000	10710lm/91W	14420lm/124W

Lumen Values: Luminaire luminous flux at 4000K/CRI>80 / surface finished Snow White. Other configurations on request.

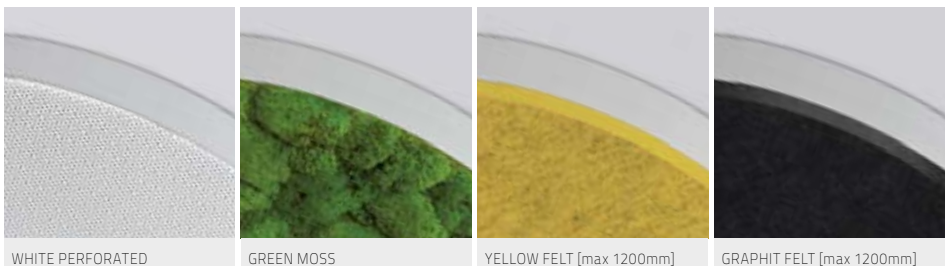

# RINGO STAR CLUSTER SUSPENDED





LIGHTNET SHOWROOM COLOGNE, GERMANY  
RINGO STAR CLUSTER + LIQUID LINE

# RINGO STAR CLUSTER SUSPENDED





IDEAL VERSICHERUNG, BERLIN, GERMANY  
RINGO STAR CLUSTER-P3



# RINGO STAR CLUSTER SUSPENDED





LOBBY FITOUT, BERLIN, GERMANY  
RINGO STAR CLUSTER

RINGO STAR CLUSTER  
SUSPENDED | G3/P3



**DE** LED-System-Pendelleuchte. Direkt-indirekt oder rein direktstrahlend. Lichtsystem mit beliebiger Kombination der unterschiedlichen X-, Y- und Kreismodule, jedes Modul als Einzeleuchte erhältlich. Für jede Stoßstelle sind ein Verbinder und eine Seilabhängung separat zu bestellen. Darüber hinaus volle Kompatibilität mit allen Liquid Line G3/P3 Modulen. Leuchtenkörper aus Aluminiumprofil mit 60mm Lichtspurbreite. Oberfläche weiß, silber, graphit, schwarz, champagner oder kupferfarben lackiert. Weitere Oberflächenoptionen siehe Lightnet-Surface-Collection oder RAL nach Wahl. Optional innenliegender akustisch hochwirksamer Breitbandabsorber zur Regulierung der Nachhallzeit wählbar aus 4 Varianten (Green Moss, Yellow Felt, Graphite Felt oder White Perforated). Satiierter Opal-diffusor für Allgemeinbeleuchtung. Konverter jeweils in Leuchtgehäuse integriert, wahlweise einfach schaltbar oder stufenlos dimmbar (1-10V, DALI, Touch-Dim, Casambi). Farbtemperaturen 2200K, 2700K, 3000K, 3500K, 4000K oder 6500K. Binning initial  $\leq$  MacAdam 3. Farbwiedergabe CRI>80 oder CRI>90. Deckenbaldachin mit transparent ummantelter Zuleitung je gesamte Lichtstruktur separat zu bestellen.

**EN** LED pendant light system. Direct-indirect or direct-only light distribution. Lighting system with various combinations of the different X, Y and circular modules, each module available as stand-alone luminaire. A connector and a cord-holder have to be ordered separately for each joint. Furthermore entirely compatible with all Liquid Line G3/P3 modules. Luminaire body made of aluminium profile with 60mm width. Surface white, silver, graphite, black, champagne or copper coated. Further surface options see Lightnet-Surface-Collection or RAL of your choice. Optionally internal acoustically highly effective broadband absorber for reducing the reverberation time, 4 options (Green Moss, Yellow Felt, Graphite Felt or White Perforated). Satin opal diffuser for general lighting. Converter integrated into luminaire housing, optionally switchable or dimmable (1-10V, DALI, Touch-Dim, Casambi). Colour temperatures 2200K, 2700K, 3000K, 3500K, 4000K or 6500K. Binning initial  $\leq$  MacAdam 3. Colour rendering CRI>80 or CRI>90. Ceiling rose with transparent power supply cable has to be ordered separately for each complete light structure.

**FR** Système d'éclairage LED suspendu. Éclairage direct /indirect ou seulement direct. Système d'éclairage avec différentes combinaisons au choix de différents modules X, Y et circulaires, chaque module étant disponible comme luminaire individuel. Un connecteur et une suspension de câble sont à commander séparément pour chaque section. Compatibilité et modularité également avec tous les modules de la famille Liquid Line G3/P3. Corps du luminaire en profilé aluminium avec 60mm de largeur du spectre lumineux. Surface laquée blanc, argent, graphite, noir, champagne ou cuivre. Autres options de finition voir Lightnet-Surface-Collection ou RAL au choix. En option, élément acoustique intérieur large très efficace pour la régulation du temps de réverbération, 4 variantes au choix (Green Moss, Yellow Felt, Graphite Felt oder White Perforated). Diffuseur opale satinée pour un éclairage général. Driver intégré dans le luminaire, au choix ON/OFF ou graduable (1-10V, DALI, Touch-Dim, Casambi). Température de couleur 2200K, 2700K, 3000K, 3500K, 4000K ou 6500K. Binning initial  $\leq$  MacAdam 3. Rendu de couleur CRI>80 ou CRI>90. Baldaquin/patère avec câble d'alimentation transparent, à commander séparément pour chaque structure lumineuse complète.

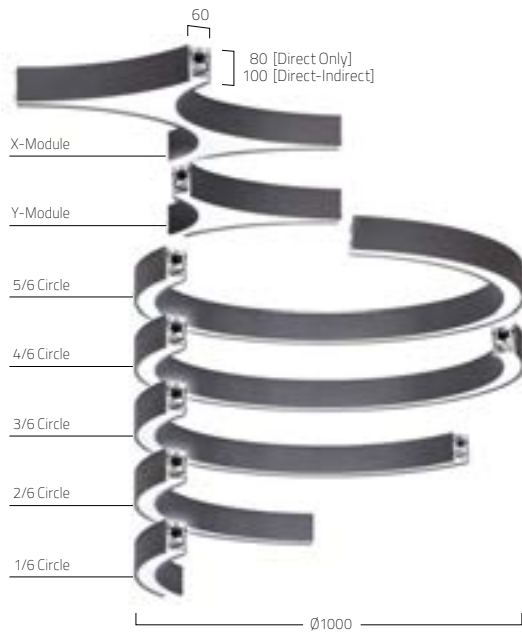

**PRODUCT-CODE:** RP3 OSE-830M-C1

- PRODUCT FAMILY – R: Ringo Star Cluster
- TYPE – G3: Direct Only, P3: Direct-Indirect
- OPTICAL SYSTEM – O: Opal
- SURFACE FINISH – W: Snow White, V: Ivory White, S: Radiant Silver, U: Urban Graphite, B: Jet Black, H: Champagne Silver, K: Satin Copper
- CONTROL GEAR – E: On/Off, L: DALI, D: 1-10V, H: Touch-Dim, C: Casambi, U: Separately Dimmable DALI
- COLOUR REND. – 8: CRI>80, 9: CRI>90, F: Full Spectrum
- COLOUR TEMP. – 22: 2200K, 27: 2700K, 30: 3000K, 35: 3500K, 40: 4000K, 65: 6500K
- POWER – E: Low Power, M: Medium Power
- MODULE TYPE – C1: 1/6 Circle, C2: 2/6 Circle, C3: 3/6 Circle, C4: 4/6 Circle, C5: 5/6 Circle, Y: Y-Module, X: X-Module
- ON REQUEST – Cable Colour: Black, Red

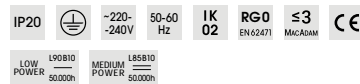

**ACOUSTIC ABSORBERS**

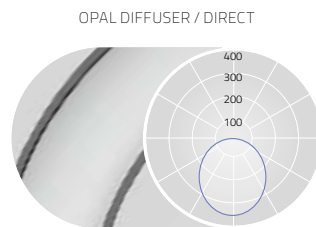
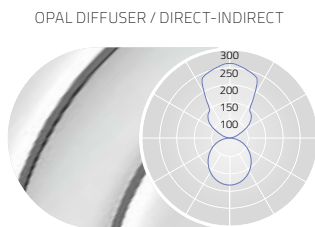
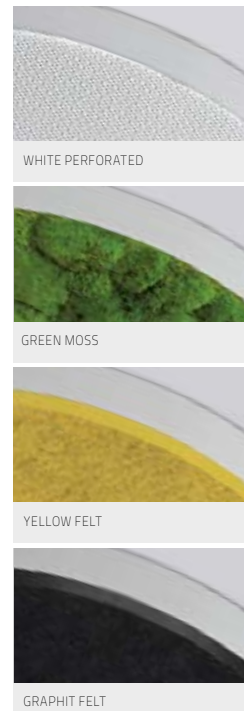

DIRECT: ca.40% INDIRECT ca.60%

DIRECT: 100%

Module Type	Lumen/Watt Low Power	Lumen/Watt Medium Power
C1	1500lm/16W	2200lm/22W
C2	1700lm/20W	2490lm/28W
C3	3680lm/37W	5380lm/51W
C4	4700lm/48W	6880lm/68W
C5	6520lm/63W	9560lm/88W
X	6630lm/52W	9740lm/78W
Y	3320lm/26W	4870lm/39W

Module Type	Lumen/Watt Low Power	Lumen/Watt Medium Power
C1	530lm/9W	770lm/12W
C2	1050lm/16W	1540lm/22W
C3	1740lm/24W	2550lm/34W
C4	2100lm/28W	3080lm/40W
C5	2630lm/34W	3850lm/48W
X	4470lm/37W	6560lm/57W
Y	2240lm/20W	3280lm/30W

Lumen Values: Luminaire luminous flux at 4000K/CRI>80 / surface finished Snow White. Other configurations on request.



RINGO STAR READY CHAIN  
SUSPENDED | G3/P3



**DE** LED-Pendelleuchte. Fertig konfigurierte Lichtstruktur mit allen erforderlichen Lichtmodulen, Verbindern und Seilabhängungen. Direkt-indirekt oder rein direkt-strahlend. Leuchtenkörper aus Aluminiumprofil mit 60mm Lichtspurbreite. Oberfläche weiß, silber, graphit, schwarz, champagner oder kupferfarben lackiert. Weitere Oberflächenoptionen siehe Lightnet-Surface-Collection oder RAL nach Wahl. Optional innenliegender akustisch hochwirksamer Breitbandabsorber zur Regulierung der Nachhallzeit wählbar aus 4 Varianten (Green Moss, Yellow Felt, Graphite Felt oder White Perforated). Satin opal diffuser for general lighting. Converter integrated into luminaire housing, optionally switchable or dimmable (1-10V, DALI, Touch-Dim, Casambi). Colour temperatures 2200K, 2700K, 3000K, 3500K, 4000K oder 6500K. Binning initial  $\leq$  MacAdam 3. Farbwiedergabe CRI>80 oder CRI>90. Lieferung bis Ausführung 2 Ringe als fertig montierbare Einheit in einem Stück. Stufenlos höhenverstellbare Parallel-Seilabhängung mit transparent ummantelter Zuleitung.

**EN** LED pendant luminaire. Completely configured light structure with all necessary light modules, connectors and cord-holders. Direct-indirect or Direct Only light distribution. Luminaire body made of aluminium profile with 60mm width. Surface white, silver, graphite, black, champagne or copper coated. Further surface options see Lightnet-Surface-Collection or RAL of your choice. Optionally internal acoustically highly effective broadband absorber for reducing the reverberation time, 4 options (Green Moss, Yellow Felt, Graphite Felt or White Perforated). Satin opal diffuser for general lighting. Converter integrated into luminaire housing, optionally switchable or dimmable (1-10V, DALI, Touch-Dim, Casambi). Colour temperatures 2200K, 2700K, 3000K, 3500K, 4000K or 6500K. Binning initial  $\leq$  MacAdam 3. Colour rendering CRI>80 or CRI>90. Supplied as a ready-to-mount unit in one piece up to version 2 rings. Height-adjustable parallel-cord suspension with transparent power supply cable.

**FR** Luminaire LED suspendu. Structure lumineuse entièrement configurée avec tous les modules, connecteurs et suspensions de câbles nécessaires. Éclairage direct/indirect ou seulement direct. Corps du luminaire en profilé aluminium avec 60mm de largeur du spectre lumineux. Surface laquée blanc, argent, graphite, noir, champagne ou cuivre. Autres options de finition voir Lightnet-Surface-Collection ou RAL au choix. En option, élément acoustique intérieur large très efficace pour la régulation du temps de réverbération, 4 variantes au choix (Green Moss, Yellow Felt, Graphite Felt oder White Perforated). Diffuseur opale satinée pour un éclairage général. Driver intégré dans le luminaire, au choix ON/OFF ou graduable (1-10V, DALI, Touch-Dim, Casambi). Température de couleur 2200K, 2700K, 3000K, 3500K, 4000K ou 6500K. Binning initial  $\leq$  MacAdam 3. Rendu de couleur CRI>80 ou CRI>90. Livraison d'un luminaire en un morceau prêt à installer jusqu'à 2 anneaux. Filin parallèle droit et tendeur rapide réglable avec câble d'alimentation transparent.

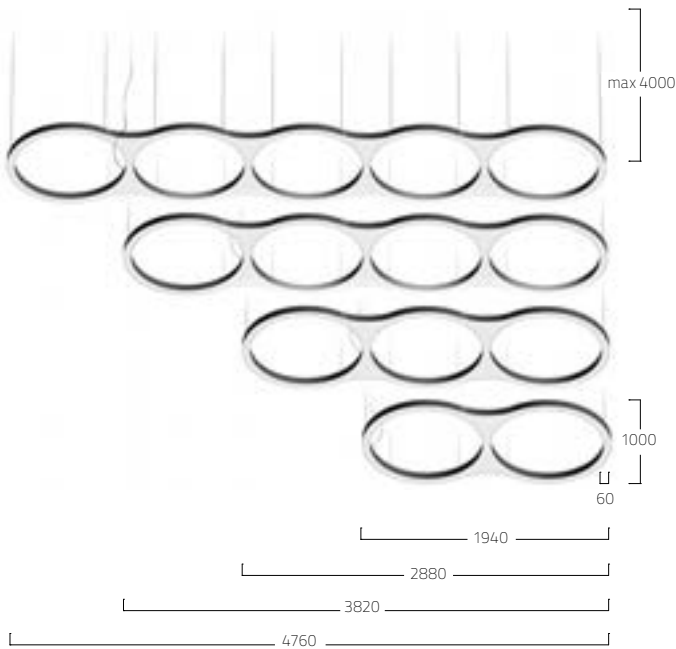

**PRODUCT-CODE: R P 3 O S E - 8 30 M - 2R - K**

PRODUCT FAMILY	- R: Ringo Star Ready Chain
TYPE	- G3: Direct Only, P3: Direct-Indirect
OPTICAL SYSTEM	- O: Opal
SURFACE FINISH	- W: Snow White, V: Ivory White, S: Radiant Silver, U: Urban Graphite, B: Jet Black, H: Champagne Silver, K: Satin Copper
CONTROL GEAR	- E: On/Off, L: DALI, D: 1-10V, H: Touch-Dim, C: Casambi, U: Separately Dimmable DALI
COLOUR REND.	- 8: CRI>80, 9: CRI>90, F: Full Spectrum
COLOUR TEMP.	- 22: 2200K, 27: 2700K, 30: 3000K, 35: 3500K, 40: 4000K, 65: 6500K
POWER	- E: Low Power, M: Medium Power
CHAIN TYPE	- 2R: 2 Rings, 3R: 3 Rings, 4R: 4 Rings, 5R: 5 Rings
SUSPENSION	- K: Parallel Suspension
ON REQUEST	- Cable Colour: Black, Red

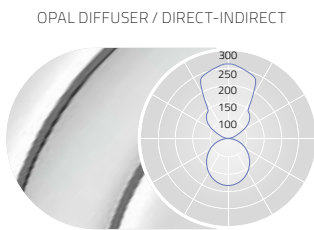
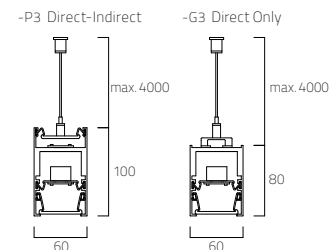

DIRECT: ca.40% INDIRECT ca.60%

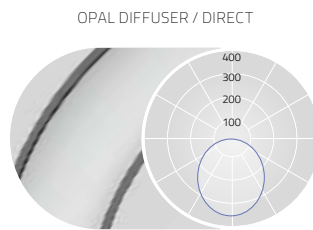

DIRECT: 100%

Ready Chain Type	Length [mm]	Lumen/Watt Low Power	Lumen/Watt Medium Power	Ready Chain Type	Length [mm]	Lumen/Watt Low Power	Lumen/Watt Medium Power
2 Rings	1940	14120lm/134W	20770lm/202W	2 Rings	1940	7020lm/88W	10320lm/134W
3 Rings	2880	21880lm/208W	32180lm/313W	3 Rings	2880	10890lm/136W	16020lm/204W
4 Rings	3820	29640lm/282W	43590lm/430W	4 Rings	3820	14770lm/185W	21720lm/282W
5 Rings	4760	37400lm/356W	55000lm/540W	5 Rings	4760	18650lm/233W	27420lm/353W

Lumen Values: Luminaire luminous flux at 4000K/CRI>80 / surface finished Snow White. Other configurations on request.

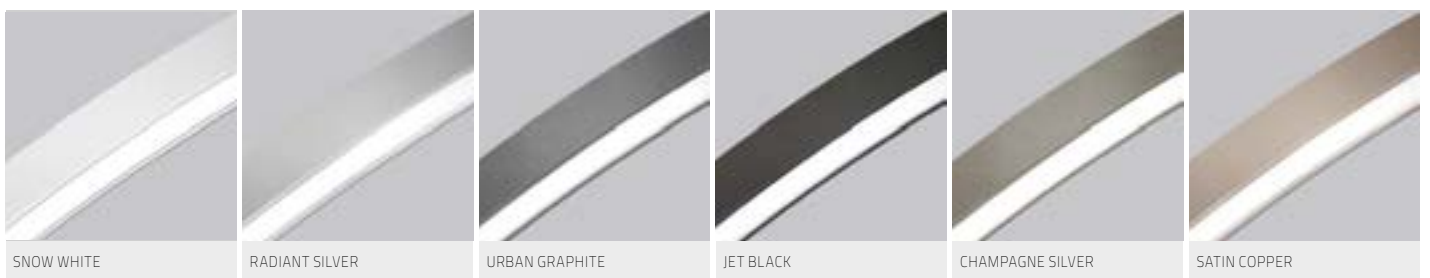

# LIQUID LINE SUSPENDED





GOVERNMENT BUILDING RIJNSTRAAT 8, DEN HAAG, NETHERLANDS  
LIQUID LINE G3  
LIGHTING DESIGN: MAAS & HAGOORT



# LIQUID LINE SUSPENDED



SPARKASSE WEIDEN, WEIDEN, GERMANY  
LIQUID LINE-G3

PHOTOS: MARTIN KREUZER PHOTOGRAPHY



GAZPROM HEADQUARTERS, MOSCOW, RUSSIA  
LIQUID LINE-G3



MORWELL FEDERATION TRAINING CENTER, AUSTRALIA  
LIQUID LINE G3

# LIQUID LINE SUSPENDED



NH-HOTEL, BRUSSELS, BELGIUM  
LIQUID LINE-P3



# LIQUID LINE SUSPENDED

COVESTRO DEUTSCHLAND AG, BERLIN, GERMANY  
LIQUID LINE-P3  
PHOTOS: AKIM PHOTOGRAPHY  
PROJECT MANAGEMENT: DESIGNFUNKTION RHEINLAND GMBH





UNITED AIRLINES, HOUSTON, USA  
LIQUID LINE-P3



WESCO, CERIZAY, FRANCE  
LIQUID LINE-G3

# LIQUID LINE SUSPENDED

GOTHAER VERSICHERUNG, AGENTUR FISCHER UND PELCZYNSKI,  
COLOGNE, GERMANY  
LIQUID LINE - P3





KERNBÜRGERAMT-NEUSS, GERMANY  
LIQUID LINE - G5 [SPECIAL WIDTH 100MM]



# LIQUID LINE LINEAR MODULES SUSPENDED | G3/P3



**DE** LED-System-Pendelleuchte. Direkt-indirekt oder rein direktstrahlend. Leuchtenkörper aus Aluminiumprofil mit 60mm Lichtspurbreite. Oberfläche weiß, silber, graphit, schwarz, champagner oder kupferfarben lackiert. Weitere Oberflächenoptionen siehe Lightnet-Surface-Collection oder RAL nach Wahl. Microprismenoptik mit optimierter Blendungsbegrenzung speziell für Office-Anwendungen. Satinierter Opaldiffusor für Allgemeinbeleuchtung. Konverter in Leuchtgehäuse integriert, wahlweise einfach schaltbar oder stufenlos dimmbar (1-10V, DALI, Touch-Dim, Casambi). Farbtemperaturen 2200K, 2700K, 3000K, 3500K, 4000K oder 6500K. Binning initial  $\leq$  MacAdam 3. Farbwiedergabe CRI>80 oder CRI>90. Beliebige Kombination von 90°-Modulen mit allen linearen sowie gebogenen Elementen der Familie Liquid Line 3D übergreifend möglich. Hochflexibles System geeignet für millimetergenauen Zuschnitt auf Maß sowie Individualösungen. Jedes Modul auch als Einzel-leuchte erhältlich. Stirnseiten sind separat zu bestellen. Bei Lichtbandmontage sind für jede Stoßstelle ein Verbinder und eine Seilabhangung separat zu bestellen.

**EN** LED pendant light system. Direct-indirect or direct-only light distribution. Luminaire body made of aluminium profile with 60mm width. Surface white, silver, graphite, black, champagne or copper coated. Further surface options see Lightnet-Surface-Collection or RAL of your choice. Microprismatic with optimized glare reduction especially for workplaces. Satin opal diffuser for general lighting. Converter integrated into luminaire housing, optionally switchable or dimmable (1-10V, DALI, Touch-Dim, Casambi). Colour temperatures 2200K, 2700K, 3000K, 3500K, 4000K or 6500K. Binning initial  $\leq$  MacAdam 3. Colour rendering CRI>80 or CRI>90. Arbitrary combination of 90° modules with all linear as well as curved elements of the Liquid Line 3D family is possible. Highly flexible system suited for millimetre accurate customizing as well as individual solutions. Each module is also available as stand-alone luminaire. End caps to be ordered separately. For continuous lines of light one connector and one cord-holder for each joint to be ordered separately.

**FR** Systeme d'clairage LED suspendu. clairage direct /indirect ou seulement direct. Corps du luminaire en profil aluminium avec 60mm de largeur du spectre lumineux. Surface laquee blanc, argent, graphite, noir, champagne ou cuivre. Autres options de finition voir Lightnet-Surface-Collection ou RAL au choix. Diffuseur microprismatique optimise pour un blouissement limite et adapte aux bureaux. Diffuseur opale satine pour un clairage general. Driver integre dans le luminaire, au choix ON/OFF ou graduable (1-10V, DALI, Touch-Dim, Casambi). Temperature de couleur 2200K, 2700K, 3000K, 3500K, 4000K ou 6500K. Binning initial  $\leq$  Mac Adam 3. Rendu de couleur CRI>80 ou CRI>90. Combinaison possible et melangee au choix des modules angle  90° avec tous les lements droits tout comme les modules cintres de la famille Liquid Line 3D. Systeme d'clairage hautement flexible adapte pour des solutins individuelles multiples au millimetre pres. Chaque module disponible comme luminaire independant autonome. Cache frontal  commander separement. Pour un montage en continu les connecteurs et suspensions sont  commander separement pour chaque jonction.

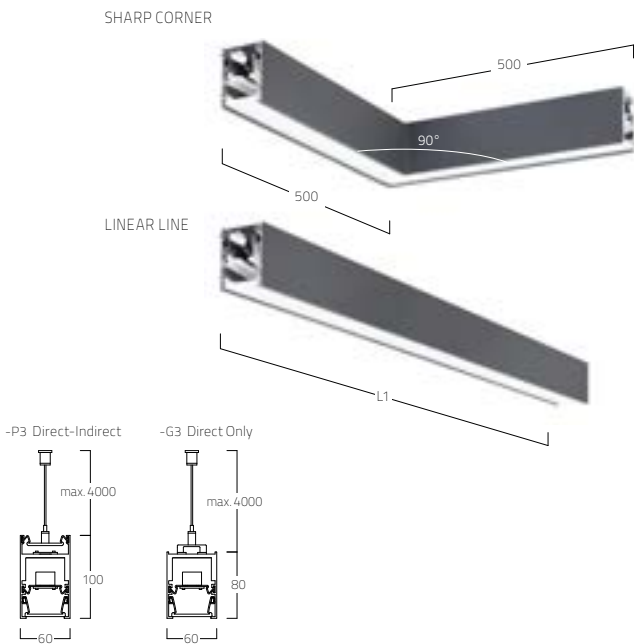

**PRODUCT-CODE:** Q P3 A S E - 8 30 M - L 1178 - A

PRODUCT FAMILY	- Q: Liquid Line
TYPE	- G3: Direct Only, P3: Direct-Indirect
OPTICAL SYSTEM	- A: Microprismatic, O: Opal
SURFACE FINISH	- W: Snow White, V: Ivory White, S: Radiant Silver, U: Urban Graphite, B: Jet Black, H: Champagne Silver, K: Satin Copper
CONTROL GEAR	- E: On/Off, L: DALI, D: 1-10V, H: Touch-Dim, C: Casambi, U: Separately Dimmable DALI
COLOUR REND.	- 8: CRI>80, 9: CRI>90, F: Full Spectrum
COLOUR TEMP.	- 22: 2200K, 27: 2700K, 30: 3000K, 35: 3500K, 40: 4000K, 65: 6500K
POWER	- E: Low Power, M: Medium Power, H: High Power
FORM	- L: Line, K: Corner
SIZE	- Line Length in mm: 600, 888, 1178, 1472, 2340, Corner: 500x500
SUSPENSION	- A: Single Cord Suspension
ON REQUEST	- Emergency Module, Cable colour Red or Black, Tunable White

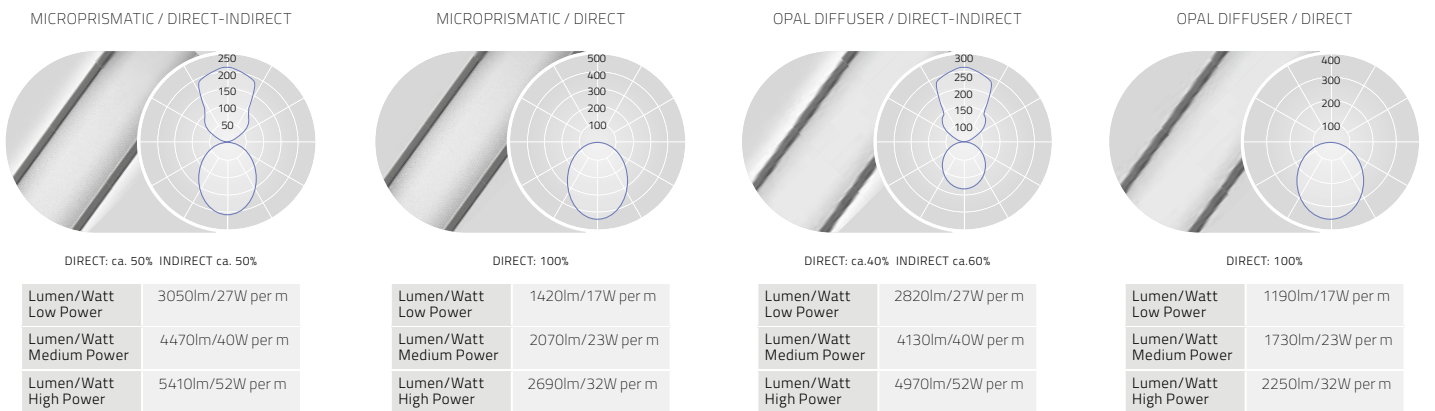

Lumen Values: Luminaire luminous flux at 4000K/CRI>80 / surface finished Snow White. Other configurations on request.



# LIQUID LINE BEND MODULES SUSPENDED | G3/P3



**DE** LED-System-Pendelleuchte. Direkt-indirekt oder rein direktstrahlend. Leuchtenkörper aus Aluminiumprofil mit 60mm Lichtspurbreite. Oberfläche weiß, silber, graphit, schwarz, champagner oder kupferfarben lackiert. Weitere Oberflächenoptionen siehe Lightnet-Surface-Collection oder RAL nach Wahl. Microprismenoptik mit optimierter Blendungsbegrenzung speziell für Office-Anwendungen. Satinierter Opaldiffusor für Allgemeinbeleuchtung. Konverter in Leuchtgehäuse integriert, wahlweise einfach schaltbar oder stufenlos dimmbar (1-10V, DALI, Touch-Dim, Casambi). Farbtemperaturen 2200K, 2700K, 3000K, 3500K, 4000K oder 6500K. Binning initial  $\leq$  MacAdam 3. Farbwiedergabe CRI>80 oder CRI>90. Beliebige Kombination gebogener Module mit allen linearen sowie kreisförmigen Elementen der Familie Liquid Line 3D übergreifend möglich. Hochflexibles System geeignet für millimetergenauen Zuschnitt auf Maß sowie Individuallösungen. Jedes Modul auch als Einzeleuchte erhältlich. Stirnseiten sind separat zu bestellen.

**EN** LED pendant light system. Direct-indirect or direct-only light distribution. Luminaire body made of aluminium profile with 60mm width. Surface white, silver, graphite, black, champagne or copper coated. Further surface options see Lightnet-Surface-Collection or RAL of your choice. Microprismatic with optimized glare reduction especially for workplaces. Satin opal diffuser for general lighting. Converter integrated into luminaire housing, optionally switchable or dimmable (1-10V, DALI, Touch-Dim, Casambi). Colour temperatures 2200K, 2700K, 3000K, 3500K, 4000K or 6500K. Binning initial  $\leq$  MacAdam 3. Colour rendering CRI>80 or CRI>90. Arbitrary combination of curved modules with all linear as well as circular elements of the Liquid Line 3D family is possible. Highly flexible system suited for millimetre accurate customizing as well as individual solutions. Each module is also available as stand-alone luminaire. End caps to be ordered separately. For continuous lines of light one connector and one cord-holder for each joint to be ordered separately.

**FR** Système d'éclairage LED suspendu. Éclairage direct/indirect ou seulement direct. Corps du luminaire en profilé aluminium avec 60mm de largeur du spectre lumineux. Surface laquée blanc, argent, graphite, noir, champagne ou cuivre. Autres options de finition voir Lightnet-Surface-Collection ou RAL au choix. Diffuseur microprismatique optimisé pour un éblouissement limité et adapté aux bureaux. Diffuseur opale satinée pour un éclairage général. Driver intégré dans le luminaire, au choix ON/OFF ou graduable (1-10V, DALI, Touch-Dim, Casambi). Température de couleur 2200K, 2700K, 3000K, 3500K, 4000K ou 6500K. Binning initial  $\leq$  Mac Adam 3. Rendu de couleur CRI>80 ou CRI>90. Combinaison possible et mélangée au choix des modules cintrés avec tous les éléments droits et ronds de la famille Liquid Line 3D. Système d'éclairage hautement flexible adapté pour des solutions individuelles multiples au millimètre près. Chaque module disponible comme luminaire indépendant autonome. Cache frontal à commander séparément.

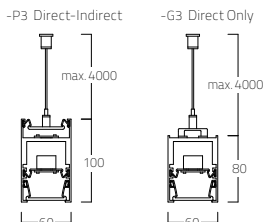
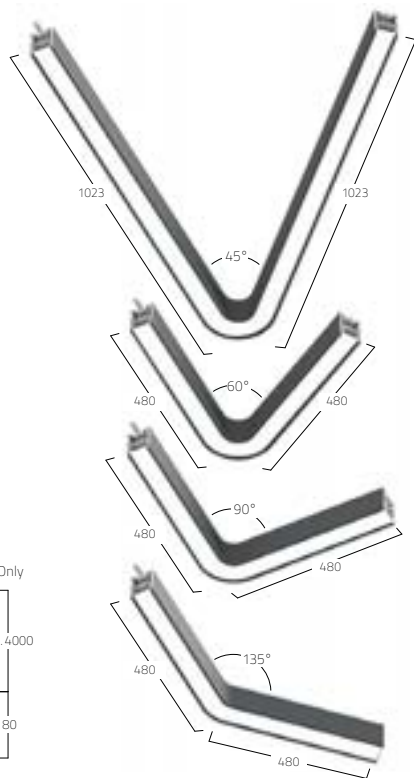

**PRODUCT-CODE:** Q P3 A S E - 8 30 M - B 135 - A

PRODUCT FAMILY	Q. Liquid Line
TYPE	G3 Direct Only, P3 Direct-Indirect
OPTICAL SYSTEM	A Microprismatic, O Opal
SURFACE FINISH	W: Snow White, V: Ivory White, S: Radiant Silver, U: Urban Graphite, B: Jet Black, H: Champagne Silver, K: Satin Copper
CONTROL GEAR	E: On/Off, L: DALI, D: 1-10V, H: Touch-Dim, C: Casambi, U: Separately Dimmable DALI
COLOUR REND.	8: CRI>80, 9: CRI>90, F: Full Spectrum
COLOUR TEMP.	22: 2200K, 27: 2700K, 30: 3000K, 35: 3500K, 40: 4000K, 65: 6500K
POWER	E: Low Power, M: Medium Power, H: High Power
FORM	B: Bend Module
ANGLE	Degree: 45°, 60°, 90°, 135°
SUSPENSION	A: Single Cord Suspension
ON REQUEST	Emergency Module, Cable colour Red or Black, Tunable White



MICROPRISMATIC / DIRECT-INDIRECT

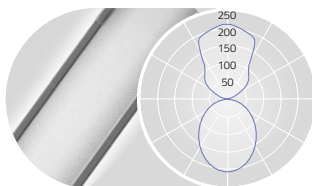

DIRECT: ca. 50% INDIRECT ca. 50%

Lumen/Watt Low Power	3050lm/27W per m
Lumen/Watt Medium Power	4470lm/40W per m
Lumen/Watt High Power	5410lm/52W per m

MICROPRISMATIC / DIRECT

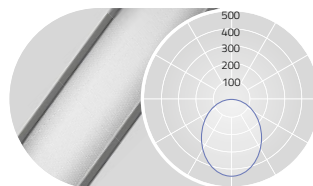

DIRECT: 100%

Lumen/Watt Low Power	1420lm/17W per m
Lumen/Watt Medium Power	2070lm/23W per m
Lumen/Watt High Power	2690lm/32W per m

OPAL DIFFUSER / DIRECT-INDIRECT

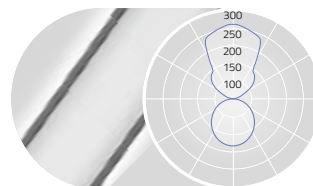

DIRECT: ca.40% INDIRECT ca.60%

Lumen/Watt Low Power	2820lm/27W per m
Lumen/Watt Medium Power	4130lm/40W per m
Lumen/Watt High Power	4970lm/52W per m

OPAL DIFFUSER / DIRECT

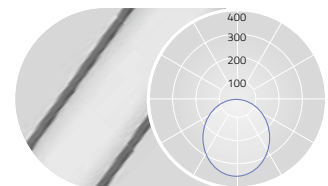

DIRECT: 100%

Lumen/Watt Low Power	1190lm/17W per m
Lumen/Watt Medium Power	1730lm/23W per m
Lumen/Watt High Power	2250lm/32W per m

Lumen Values: Luminaire luminous flux at 4000K/CRI>80 / surface finished Snow White. Other configurations on request.



# LIQUID LINE CURVE MODULES SUSPENDED | G3/P3



**DE** LED-System-Pendelleuchte. Direkt-indirekt oder rein direktstrahlend. Leuchtenkörper aus Aluminiumprofil mit 60mm Lichtspurbreite. Oberfläche weiß, silber, graphit, schwarz, champagner oder kupferfarben lackiert. Weitere Oberflächenoptionen siehe Lightnet-Surface-Collection oder RAL nach Wahl. Microprismenoptik mit optimierter Blendungsbegrenzung speziell für Office-Anwendungen. Satinierter Opaldiffusor für Allgemeinbeleuchtung. Konverter in Leuchtgehäuse integriert, wahlweise einfach schaltbar oder stufenlos dimmbar (1-10V, DALI, Touch-Dim, Casambi). Farbtemperaturen 2200K, 2700K, 3000K, 3500K, 4000K oder 6500K. Binning initial  $\leq$  MacAdam 3. Farbwiedergabe CRI>80 oder CRI>90. Beliebige Kombination von Kreiselementen mit allen linearen sowie gebogenen Elementen der Familie Liquid Line 3D übergreifend möglich. Hochflexibles System geeignet für millimetergenauen Zuschnitt auf Maß sowie Individuallösungen.

**EN** LED pendant light system. Direct-indirect or direct-only light distribution. Luminaire body made of aluminium profile with 60mm width. Surface white, silver, graphite, black, champagne or copper coated. Further surface options see Lightnet-Surface-Collection or RAL of your choice. Microprismatic with optimized glare reduction especially for workplaces. Satin opal diffuser for general lighting. Converter integrated into luminaire housing, optionally switchable or dimmable (1-10V, DALI, Touch-Dim, Casambi). Colour temperatures 2200K, 2700K, 3000K, 3500K, 4000K or 6500K. Binning initial  $\leq$  MacAdam 3. Colour rendering CRI>80 or CRI>90. Arbitrary combination of circular elements with all linear as well as curved elements of the Liquid Line 3D family is possible. Highly flexible system suited for millimetre accurate customizing as well as individual solutions. Each module is also available as stand-alone luminaire. End caps to be ordered separately.

**FR** Système d'éclairage LED suspendu. Éclairage direct /indirect ou seulement direct. Corps du luminaire en profilé aluminium avec 60mm de largeur du spectre lumineux. Surface laquée blanc, argent, graphite, noir, champagne ou cuivre. Autres options de finition voir Lightnet-Surface-Collection ou RAL au choix. Diffuseur microprismatique optimisé pour un éblouissement limité et adapté aux bureaux. Diffuseur opale satinée pour un éclairage général. Driver intégré dans le luminaire, au choix ON/OFF ou graduable (1-10V, DALI, Touch-Dim, Casambi). Température de couleur 2200K, 2700K, 3000K, 3500K, 4000K ou 6500K. Binning initial  $\leq$  Mac Adam 3. Rendu de couleur CRI>80 ou CRI>90. Combinaison possible et mélangée au choix des éléments ronds avec tous les modules droits et cintrés de la famille Liquid Line 3D. Système d'éclairage hautement flexible adapté pour des solutions individuelles multiples au millimètre près.

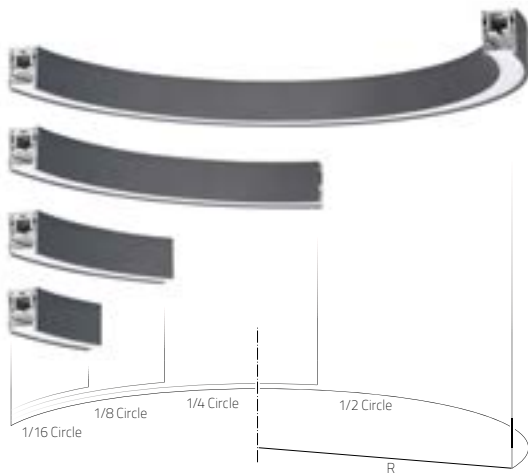

**PRODUCT-CODE: Q P3 O SE - 8 30 M - CH - R050 - L1570 - A**

PRODUCT FAMILY	- Q Liquid Line
TYPE	- G3 Direct Only, P3 Direct-Indirect
OPTICAL SYSTEM	- A Microprismatic, O Opal
SURFACE FINISH	- W Snow White, V Ivory White, S Radiant Silver, B Jet Black, U Urban Graphite, H Champagne Silver, K Satin Copper
CONTROL GEAR	- E On/Off, L DALI, D 1-10V, H Touch-Dim, C Casambi, U Separately Dimmable DALI
COLOUR REND.	- 8 CRI>80, 9 CRI>90, F Full Spectrum
COLOUR TEMP.	- 22 2200K, 27 2700K, 30 3000K, 35 3500K, 40 4000K, 65 6500K
POWER	- E Low Power, M Medium Power, H High Power
FORM	- C Curve Module
ARC SECTION	- H 1/2 curve, Q 1/4 curve, E 1/8 curve, S 1/16 curve
RADIUS	- R050 R500mm, R075 R750mm, R100 R1000mm, R125 R1250mm, R150 R1500mm, R175 R1750mm, R200 R2000mm, R250 R2500mm, R300 R3000mm, R350 R3500mm, R400 4000mm
LENGTH	- Length in mm
SUSPENSION	- A Single Cord Suspension
ON REQUEST	- Emergency Module, Cable colour Red or Black, Tunable White



R [mm]	L [mm]
500	1570
750	2355
1000	3140

1/2 CURVE - CH

R [mm]	L [mm]
500	785
750	1178
1000	1571
1250	1964
1500	2356
1750	2749
2000	3142

1/4 CURVE - CQ

R [mm]	L [mm]
1000	785
1500	1178
2000	1571
2500	1964
3000	2356
3500	2749
4000	3142

1/8 CURVE - CE

R [mm]	L [mm]
2000	785
3000	1178
3500	1374

1/16 CURVE - CS

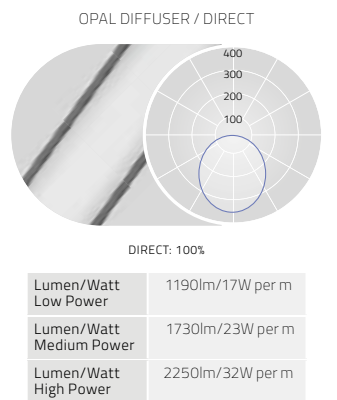
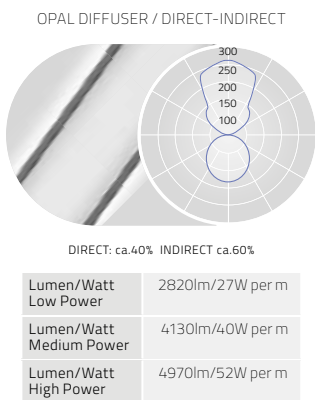
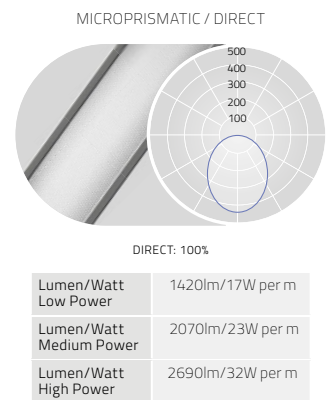
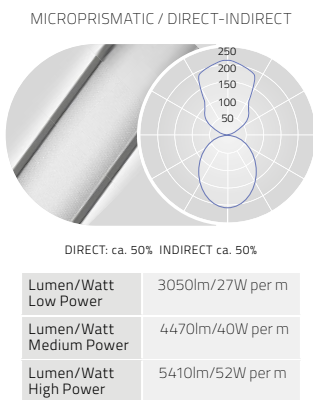

Lumen Values: Luminaire luminous flux at 4000K/CRI>80 / surface finished Snow White. Other configurations on request.



# LIQUID LINE WAVE MODULES SUSPENDED | G3/P3



**DE** LED-System-Pendelleuchte. Direkt-indirekt oder rein direktstrahlend. Leuchtenkörper aus Aluminiumprofil mit 60mm Lichtspurbreite. Oberfläche weiß, silber, graphit, schwarz, champagner oder kupferfarben lackiert. Weitere Oberflächenoptionen siehe Lightnet-Surface-Collection oder RAL nach Wahl. Microprismenoptik mit optimierter Blendungsbegrenzung speziell für Office-Anwendungen. Satinierter Opaldiffusor für Allgemeinbeleuchtung. Konverter in Leuchtgehäuse integriert, wahlweise einfach schaltbar oder stufenlos dimmbar (1-10V, DALI, Touch-Dim, Casambi). Farbtemperaturen 2200K, 2700K, 3000K, 3500K, 4000K oder 6500K. Binning initial  $\leq$  MacAdam 3. Farbwiedergabe CRI>80 oder CRI>90. Beliebige Kombination von konkaven und konvexen Modulen mit allen linearen sowie gebogenen Elementen der Familie Liquid Line 3D übergreifend möglich. Hochflexibles System geeignet für millimetergenauen Zuschnitt auf Maß sowie Individuallösungen.

**EN** LED pendant light system. Direct-indirect or direct-only light distribution. Luminaire body made of aluminium profile with 60mm width. Surface white, silver, graphite, black, champagne or copper coated. Further surface options see Lightnet-Surface-Collection or RAL of your choice. Microprismatic with optimized glare reduction especially for workplaces. Satin opal diffuser for general lighting. Converter integrated into luminaire housing, optionally switchable or dimmable (1-10V, DALI, Touch-Dim, Casambi). Colour temperatures 2200K, 2700K, 3000K, 3500K, 4000K or 6500K. Binning initial  $\leq$  MacAdam 3. Colour rendering CRI>80 or CRI>90. Arbitrary combination of concave and convex modules with all linear as well as curved elements of the Liquid Line 3D family is possible. Highly flexible system suited for millimetre accurate customizing as well as individual solutions. Each module is also available as stand-alone luminaire. End caps can be ordered separately.

**FR** Système d'éclairage LED suspendu. Éclairage direct /indirect ou seulement direct. Corps du luminaire en profilé aluminium avec 60mm de largeur du spectre lumineux. Surface laquée blanc, argent, graphite, noir, champagne ou cuivre. Autres options de finition voir Lightnet-Surface-Collection ou RAL au choix. Diffuseur microprismatique optimisé pour un éblouissement limité et adapté aux bureaux. Diffuseur opale satinée pour un éclairage général. Driver intégré dans le luminaire, au choix ON/OFF ou graduable (1-10V, DALI, Touch-Dim, Casambi). Température de couleur 2200K, 2700K, 3000K, 3500K, 4000K ou 6500K. Binning initial  $\leq$  Mac Adam 3. Rendu de couleur CRI>80 ou CRI>90. Combinaison possible et mélangée au choix des modules concaves et convexes avec tous les modules droits et cintrés de la famille Liquid Line 3D. Système d'éclairage hautement flexible adapté pour des solutions individuelles multiples au millimètre près.

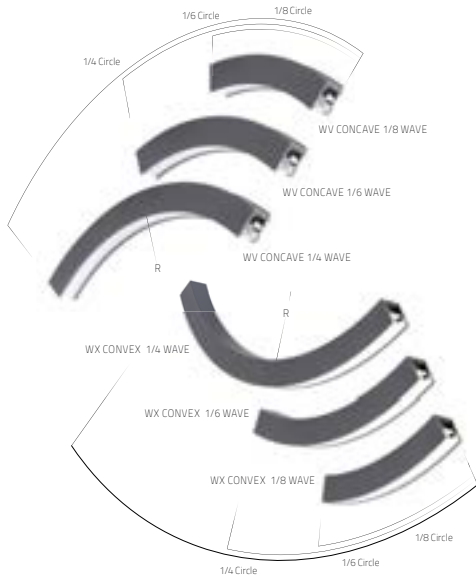

**PRODUCT-CODE:** Q G3 O S E - 8 30 E - W X E - R100 - L848 - A

PRODUCT FAMILY	- Q Liquid Line
TYPE	- G3: Direct Only, P3: Direct-Indirect
OPTICAL SYSTEM	- A: Microprismatic, O: Opal
SURFACE FINISH	- W: Snow White, V: Ivory White, S: Radiant Silver, B: Jet Black, U: Urban Graphite, H: Champagne Silver, K: Satin Copper
CONTROL GEAR	- E: On/Off, L: DALI, D: 1-10V, H: Touch-Dim, C: Casambi, U: Separately Dimmable DALI
COLOUR REND.	- 8: CRI>80, 9: CRI>90, F: Full Spectrum
COLOUR TEMP.	- 22: 2200K, 27: 2700K, 30: 3000K, 35: 3500K, 40: 4000K, 65: 6500K
POWER	- E: Low Power, M: Medium Power, H: High Power
WAVE TYPE	- WX: Convex, WV: Concave
WAVE SECTION	- Q: 1/4 wave, S: 1/6 wave, E: 1/8 wave
RADIUS	- R100: R1000mm, R125: R1250mm, R150: R1500mm
LENGTH	- Length in mm
SUSPENSION	- A: Single Cord Suspension
ON REQUEST	- Emergency Module, Cable colour Red or Black, Tunable White



WV CONCAVE 1/8 WAVE	WV CONCAVE 1/6 WAVE	WV CONCAVE 1/4 WAVE	WX CONVEX 1/8 WAVE	WX CONVEX 1/6 WAVE	WX CONVEX 1/4 WAVE
R [mm] L [mm]	R [mm] L [mm]	R [mm] L [mm]	R [mm] L [mm]	R [mm] L [mm]	R [mm] L [mm]
1000 848	1000 1131	1000 1696	1000 848	1000 1131	1000 1696
1250 1045	1250 1393	1250 2089	1250 1045	1250 1393	1250 2089
1500 1241	1500 1655	1500 2482	1500 1241	1500 1655	1500 2482

DIRECT: ca. 50% INDIRECT ca. 50%	DIRECT: 100%	DIRECT: ca.40% INDIRECT ca.60%	DIRECT: 100%
Lumen/Watt Low Power: 3050lm/27W per m	Lumen/Watt Low Power: 1420lm/17W per m	Lumen/Watt Low Power: 2820lm/27W per m	Lumen/Watt Low Power: 1190lm/17W per m
Lumen/Watt Medium Power: 4470lm/40W per m	Lumen/Watt Medium Power: 2070lm/23W per m	Lumen/Watt Medium Power: 4130lm/40W per m	Lumen/Watt Medium Power: 1730lm/23W per m
Lumen/Watt High Power: 5410lm/52W per m	Lumen/Watt High Power: 2690lm/32W per m	Lumen/Watt High Power: 4970lm/52W per m	Lumen/Watt High Power: 2250lm/32W per m

Lumen Values: Luminaire luminous flux at 4000K/CRI>80 / surface finished Snow White. Other configurations on request.





# LIQUID LINE X-JUNCTIONS MODULES SUSPENDED | G3/P3



**DE** LED-System-Pendelleuchte. Direkt-indirekt oder rein direktstrahlend. Leuchtenkörper aus Aluminiumprofil mit 60mm Lichtspurbreite. Oberfläche weiß, silber, graphit, schwarz, champagner oder kupferfarben lackiert. Weitere Oberflächenoptionen siehe Lightnet-Surface-Collection oder RAL nach Wahl. Microprismenoptik mit optimierter Blendungsbegrenzung speziell für Office-Anwendungen. Satinierter Opaldiffusor für Allgemeinbeleuchtung. Converter integriert in Leuchtgehäuse integriert, wahlweise einfach schaltbar oder stufenlos dimmbar (1-10V, DALI, Touch-Dim, Casambi). Farbtemperaturen 2200K, 2700K, 3000K, 3500K, 4000K oder 6500K. Binning initial  $\leq$  MacAdam 3. Farbwiedergabe CRI>80 oder CRI>90. Beliebige Kombination vorgefertigter X-Verbinder mit allen linearen sowie gebogenen Elementen der Familie Liquid Line 3D übergreifend möglich. Hochflexibles System geeignet für millimetergenauen Zuschnitt auf Maß sowie Individuallösungen. Jedes Modul auch als Einzelleuchte erhältlich. Stirnseiten sind separat zu bestellen. Bei Lichtbandmontage sind für jede Stoßstelle ein Verbinder und eine Seilabhangung separat zu bestellen.

**EN** LED pendant light system. Direct-indirect or direct-only light distribution. Luminaire body made of aluminium profile with 60mm width. Surface white, silver, graphite, black, champagne or copper coated. Further surface options see Lightnet-Surface-Collection or RAL of your choice. Microprismatic with optimized glare reduction especially for workplaces. Satin opal diffuser for general lighting. Converter integrated into luminaire housing, optionally switchable or dimmable (1-10V, DALI, Touch-Dim, Casambi). Colour temperatures 2200K, 2700K, 3000K, 3500K, 4000K or 6500K. Binning initial  $\leq$  MacAdam 3. Colour rendering CRI>80 or CRI>90. Arbitrary combination of precast X-connectors with all linear as well as curved elements of the Liquid Line 3D family is possible. Highly flexible system suited for millimetre accurate customizing as well as individual solutions. Each module is also available as stand-alone luminaire. End caps to be ordered separately. For continuous lines of light one connector and one cord-holder for each joint to be ordered separately.

**FR** Systeme d'clairage LED suspendu. clairage direct /indirect ou seulement direct. Corps du luminaire en profil aluminium avec 60mm de largeur du spectre lumineux. Surface laquee blanc, argent, graphite, noir, champagne ou cuivre. Autres options de finition voir Lightnet-Surface-Collection ou RAL au choix. Diffuseur microprismatique optimise pour un blouissement limite et adapte aux bureaux. Diffuseur opale satinee pour un clairage general. Driver integre dans le luminaire, au choix ON/OFF ou graduable (1-10V, DALI, Touch-Dim, Casambi). Temperature de couleur 2200K, 2700K, 3000K, 3500K, 4000K ou 6500K. Binning initial  $\leq$  Mac Adam 3. Rendu de couleur CRI>80 ou CRI>90. Combinaison possible et melangee au choix de modules en forme Y- avec des modules droits et cintres de la famille Liquid Line 3D. Systeme d'clairage hautement flexible adapte pour des solutins individuelles multiples au millimetre pres. Chaque module disponible comme luminaire independant autonome. Cache frontal  commander separement.

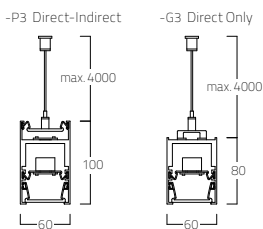
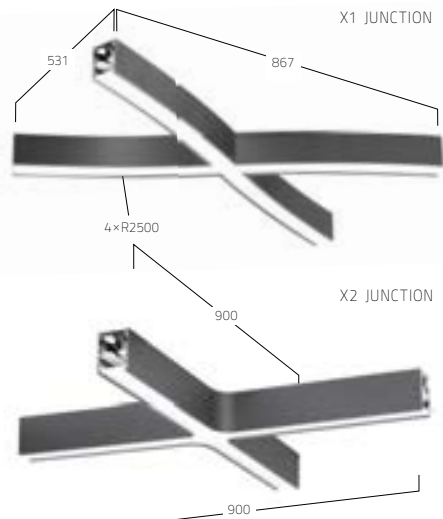

**PRODUCT-CODE: Q P3 O S E - 8 30 M - X 1 - L1920 - A**

PRODUCT FAMILY	- Q Liquid Line
TYPE	- G3: Direct Only, P3: Direct-Indirect
OPTICAL SYSTEM	- A Microprismatic, O Opal
SURFACE FINISH	- W: Snow White, V: Ivory White, S: Radiant Silver, U: Urban Graphite, B: Jet Black, H: Champagne Silver, K: Satin Copper
CONTROL GEAR	- E: On/Off, L: DALI, D: 1-10V, H: Touch-Dim, C: Casambi, U: Separately Dimmable DALI
COLOUR REND.	- 8: CRI>80, 9: CRI>90, F: Full Spectrum
COLOUR TEMP.	- 22: 2200K, 27: 2700K, 30: 3000K, 35: 3500K, 40: 4000K, 65: 6500K
POWER	- E: Low Power, M: Medium Power, H: High Power
JUNCTION FORM	- X: X-Junction
JUNCTION TYPE	- Type: 1, 2
Length	- Length in mm
SUSPENSION	- A: Single Cord Suspension
ON REQUEST	- Emergency Module, Cable colour Red or Black, Tunable White



Optical System	Beam Spread	Direct/Indirect %	Lumen/Watt
MICROPRISMATIC / DIRECT-INDIRECT	250°	DIRECT: ca. 50% INDIRECT: ca. 50%	3050lm/27W per m (Low Power)
			4470lm/40W per m (Medium Power)
			5410lm/52W per m (High Power)
MICROPRISMATIC / DIRECT	500°	DIRECT: 100%	1420lm/17W per m (Low Power)
			2070lm/23W per m (Medium Power)
			2690lm/32W per m (High Power)
OPAL DIFFUSER / DIRECT-INDIRECT	300°	DIRECT: ca. 40% INDIRECT: ca. 60%	2820lm/27W per m (Low Power)
			4130lm/40W per m (Medium Power)
			4970lm/52W per m (High Power)
OPAL DIFFUSER / DIRECT	400°	DIRECT: 100%	1190lm/17W per m (Low Power)
			1730lm/23W per m (Medium Power)
			2250lm/32W per m (High Power)

Lumen Values: Luminaire luminous flux at 4000K/CRI>80 / surface finished Snow White. Other configurations on request.



# LIQUID LINE Y-JUNCTIONS MODULES SUSPENDED | G3/P3



**DE** LED-System-Pendelleuchte. Direkt-indirekt oder rein direktstrahlend. Leuchtenkörper aus Aluminiumprofil mit 60mm Lichtspurbreite. Oberfläche weiß, silber, graphit, schwarz, champagner oder kupferfarben lackiert. Weitere Oberflächenoptionen siehe Lightnet-Surface-Collection oder RAL nach Wahl. Microprismenoptik mit optimierter Blendungsbegrenzung speziell für Office-Anwendungen. Satinierter Opaldiffusor für Allgemeinbeleuchtung. Konverter in Leuchtgehäuse integriert, wahlweise einfach schaltbar oder stufenlos dimmbar (1-10V, DALI, Touch-Dim, Casambi). Farbtemperaturen 2200K, 2700K, 3000K, 3500K, 4000K oder 6500K. Binning initial  $\leq$  MacAdam 3. Farbwiedergabe CRI>80 oder CRI>90. Beliebige Kombination vorgefertigter Y-Verbinders mit allen linearen sowie gebogenen Elementen der Familie Liquid Line 3D übergreifend möglich. Hochflexibles System geeignet für millimetergenauen Zuschnitt auf Maß sowie Individuallösungen. Jedes Modul auch als Einzelleuchte erhältlich. Stirnseiten sind separat zu bestellen.

**EN** LED pendant light system. Direct-indirect or direct-only light distribution. Luminaire body made of aluminium profile with 60mm width. Surface white, silver, graphite, black, champagne or copper coated. Further surface options see Lightnet-Surface-Collection or RAL of your choice. Microprismatic with optimized glare reduction especially for workplaces. Satin opal diffuser for general lighting. Converter integrated into luminaire housing, optionally switchable or dimmable (1-10V, DALI, Touch-Dim, Casambi). Colour temperatures 2200K, 2700K, 3000K, 3500K, 4000K or 6500K. Binning initial  $\leq$  MacAdam 3. Colour rendering CRI>80 or CRI>90. Arbitrary combination of precast Y-connectors with all linear as well as curved elements of the Liquid Line 3D family is possible. Highly flexible system suited for millimetre accurate customizing as well as individual solutions. Each module is also available as stand-alone luminaire. End caps to be ordered separately. For continuous lines of light one connector and one cord-holder for each joint to be ordered separately.

**FR** Système d'éclairage LED suspendu. Éclairage direct /indirect ou seulement direct. Corps du luminaire en profilé aluminium avec 60mm de largeur du spèctre lumineux. Surface laquée blanc, argent, graphite, noir, champagne ou cuivre. Autres options de finition voir Lightnet-Surface-Collection ou RAL au choix. Diffuseur microprismatique optimisé pour un éblouissement limité et adapté aux bureaux. Diffuseur opale satinée pour un éclairage général. Driver intégré dans le luminaire, au choix ON/OFF ou graduable (1-10V, DALI, Touch-Dim, Casambi). Température de couleur 2200K, 2700K, 3000K, 3500K, 4000K ou 6500K. Binning initial  $\leq$  MacAdam 3. Rendu de couleur CRI>80 ou CRI>90. Combinaison possible et mélangée au choix de modules en forme Y- avec des modules droits et cintrés de la famille Liquid Line 3D. Système d'éclairage hautement flexible adapté pour des solutins individuelles multiples au millimètre près. Chaque module disponible comme luminaire indépendant autonome. Cache frontal à commander séparément.

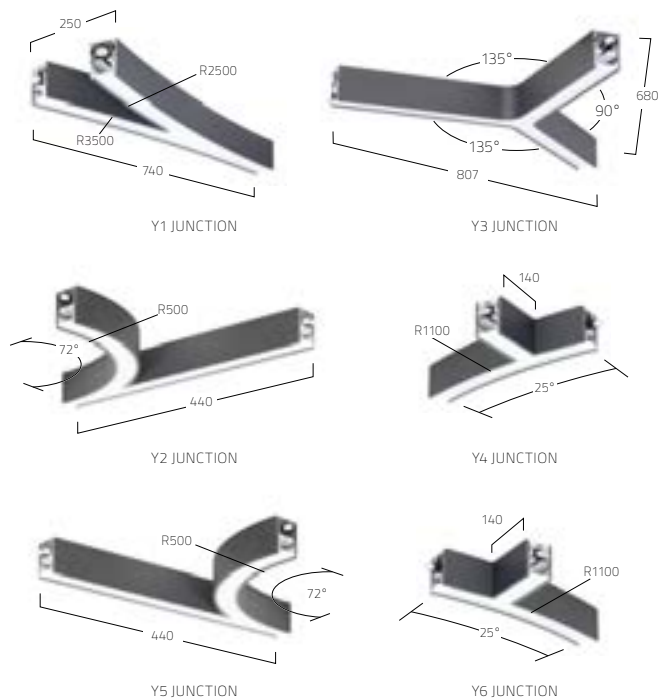

**PRODUCT-CODE:** Q P3 O S E - 8 30 M - Y 1 - L1450 - A

PRODUCT FAMILY	Q Liquid Line
TYPE	G3 Direct Only, P3 Direct-Indirect
OPTICAL SYSTEM	A Microprismatic, O Opal
SURFACE FINISH	W: Snow White, V: Ivory White, S: Radiant Silver, U: Urban Graphite, B: Jet Black, H: Champagne Silver, K: Satin Copper
CONTROL GEAR	E: On/Off, L: DALI, D: 1-10V, H: Touch-Dim, C: Casambi, U: Separately Dimmable DALI
COLOUR REND.	8: CRI>80, 9: CRI>90, F: Full Spectrum
COLOUR TEMP.	22: 2200K, 27: 2700K, 30: 3000K, 35: 3500K, 40: 4000K, 65: 6500K
POWER	E: Low Power, M: Medium Power, H: High Power
JUNCTION FORM	Y: Y-Junction
JUNCTION TYPE	Type: 1, 2, 3, 4, 5, 6
LENGTH	Length in mm
SUSPENSION	A: Single Cord Suspension
ON REQUEST	Emergency Module, Cable colour Red or Black, Tunable White



	MICROPRISMATIC / DIRECT-INDIRECT	MICROPRISMATIC / DIRECT	OPAL DIFFUSER / DIRECT-INDIRECT	OPAL DIFFUSER / DIRECT
	DIRECT: ca. 50% INDIRECT ca. 50%	DIRECT: 100%	DIRECT: ca.40% INDIRECT ca.60%	DIRECT: 100%
Lumen/Watt Low Power	3050lm/27W per m	1420lm/17W per m	2820lm/27W per m	1190lm/17W per m
Lumen/Watt Medium Power	4470lm/40W per m	2070lm/23W per m	4130lm/40W per m	1730lm/23W per m
Lumen/Watt High Power	5410lm/52W per m	2690lm/32W per m	4970lm/52W per m	2250lm/32W per m

Lumen Values: Luminaire luminous flux at 4000K/CRI>80 / surface finished Snow White. Other configurations on request.



# AMORPHICON SUSPENDED



UPC SHOP LIMMATQUAI, ZURICH, SWITZERLAND  
AMORPHICON-P1  
PLANNING: DETAIL DESIGN GMBH  
EXECUTION: MABALUX AG

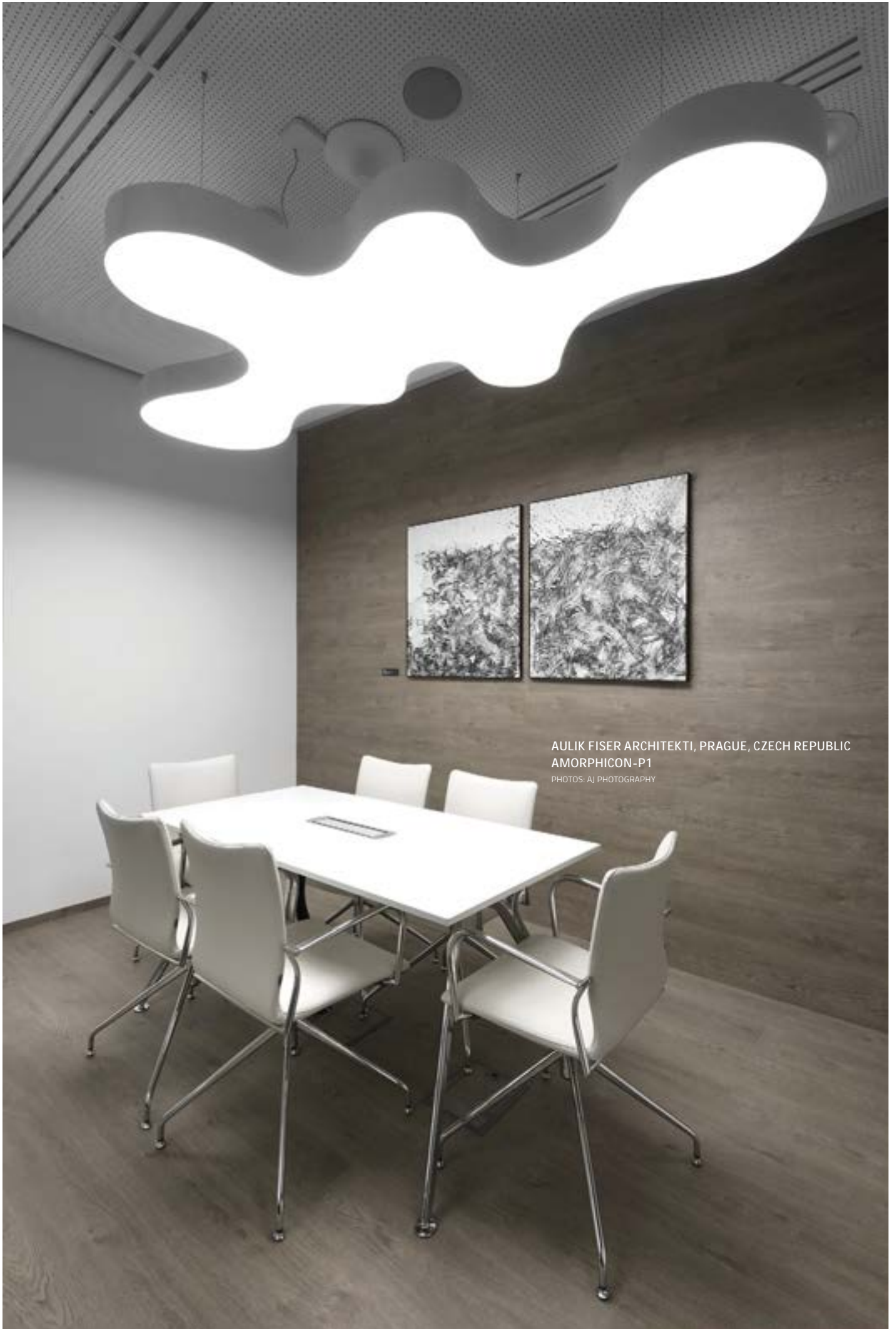

AULIK FISER ARCHITEKTI, PRAGUE, CZECH REPUBLIC  
AMORPHICON-P1  
PHOTOS: AJ PHOTOGRAPHY

AMORPHICON  
SUSPENDED | G1/P1



**DE** LED-Pendelleuchte. Rein direkt oder Direkt-indirektstrahlend. Leuchtenkörper aus Aluminium. Oberfläche weiß, silber oder schwarz. Opaldiffusor aus satiniertem Acrylglas für Allgemeinbeleuchtung. Konverter in Leuchtengehäuse integriert, wahlweise einfach schaltbar oder stufenlos dimmbar (1-10V, DALI, Touch-Dim, Casambi). Farbtemperaturen 2200K, 2700K, 3000K, 3500K, 4000K oder 6500K. Binning initial  $\leq$  MacAdam 3. Farbwiedergabe CRI>80 oder CRI>90. Stufenlos höhenverstellbare Parallelseil-Abhängung mit transparent ummantelter Zuleitung.

**EN** LED pendant luminaire. Direct only or direct-indirect light distribution. Luminaire body made of aluminium. Surface white, silver or black. Opal diffuser made of acrylic glass for general lighting. Converter integrated into luminaire housing, optionally switchable or dimmable (1-10V, DALI, Touch-Dim, Casambi). Colour temperatures 2200K, 2700K, 3000K, 3500K, 4000K or 6500K. Binning initial  $\leq$  MacAdam 3. Colour rendering CRI>80 or CRI>90. Height-adjustable parallel-cord suspension with transparent power supply cable.

**FR** Luminaire LED suspendu. Éclairage uniquement direct ou direct/indirect. Corps du luminaire en aluminium. Surface laquée blanc, argent ou noire. Diffuseur opale en verre acrylique pour éclairage général. Driver intégré dans le luminaire, au choix ON/OFF ou graduable (1-10V, DALI, Touch-Dim, Casambi). Température de couleur 2200K, 2700K, 3000K, 3500K, 4000K ou 6500K. Binning initial  $\leq$  MacAdam 3. Rendu de couleur CRI>80 ou CRI>90. Filin parallèle droit et tendeur rapide réglable avec câble d'alimentation transparent.

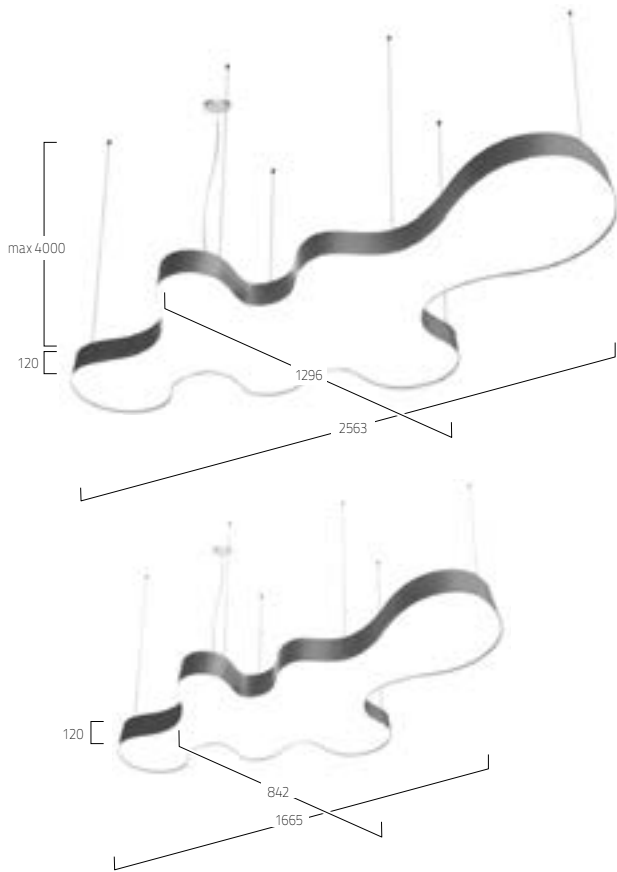

**PRODUCT-CODE: H P10SE - 830M - L1665 - K**

PRODUCT FAMILY	- H: Amorphicon
TYPE	- G1: Direct, P1: Direct-Indirect
OPTICAL SYSTEM	- O: Opal
SURFACE FINISH	- W: White, S: Silver, B: Black
CONTROL GEAR	- E: On/Off, L: DALI, D: 1-10V, H: Touch-Dim, C: Casambi
COLOUR REND.	- 8: CRI>80, 9: CRI>90, F: Full Spectrum
COLOUR TEMP.	- 22: 2200K, 27: 2700K, 30: 3000K, 35: 3500K, 40: 4000K, 65: 6500K
POWER	- M: Medium Power
SIZE	- Luminaire length in mm: L1665, L2563
SUSPENSION	- K: Parallel Suspension
ON REQUEST	- Emergency Module, Cable colour Red or Black



OPAL DIFFUSER / DIRECT-INDIRECT

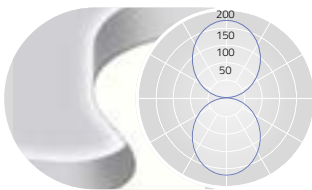

DIRECT: ca. 50% INDIRECT ca. 50%

L mm	Lumen/Watt Medium Power
1665	20390lm/153W
2563	51240lm/378W

OPAL DIFFUSER / DIRECT

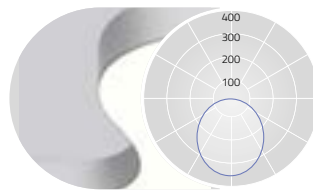

DIRECT: 100%

L mm	Lumen/Watt Medium Power
1665	10710lm/98W
2563	25430lm/232W

Lumen Values: Luminaire luminous flux at 4000K/CRI>80. Other configurations on request.





CODE ZERO  
SUSPENDED



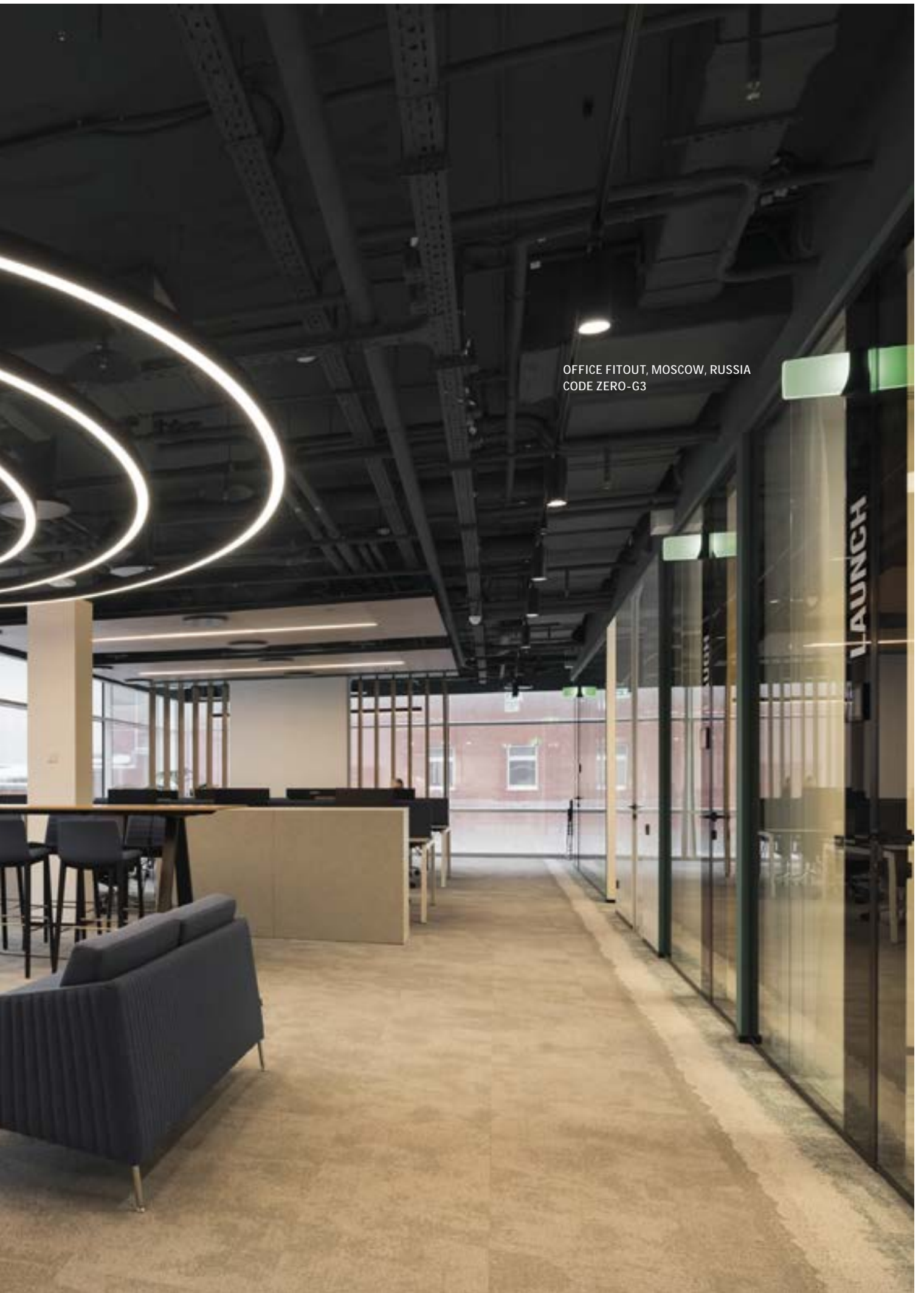

OFFICE FITOUT, MOSCOW, RUSSIA  
CODE ZERO-G3

# CODE ZERO SUSPENDED



PORT OF SALE, VICTORIA, AUSTRALIA  
CODE ZERO-G3  
PHOTOS: JOHN GOLLINGS PHOTOGRAPHY





FONDATION KRÄIZBIERG, GREVENMACHER, LUXEMBOURG  
CODE ZERO-P3

CODE ZERO  
SUSPENDED | G3/P3



**DE** LED-Pendelleuchte. Direkt-indirekt oder rein direktstrahlend. Leuchtenkörper aus elliptisch geformtem Aluminiumprofil mit 60mm Lichtspurbreite. Erhältlich in 3 Größen, Proportionsverhältnis Länge zu Breite 2:1. Oberfläche weiß, silber, graphit, schwarz, champagner oder kupferfarben lackiert. Weitere Oberflächenoptionen siehe Lightnet-Surface-Collection oder RAL nach Wahl. Satinierter Opaldiffusor für Allgemeinbeleuchtung. Konverter in Leuchtengehäuse integriert, wahlweise einfach schaltbar oder stufenlos dimmbar (1-10V, DALI, Touch-Dim, Casambi). Farbtemperaturen 2200K, 2700K, 3000K, 3500K, 4000K oder 6500K. Binning initial  $\leq$  MacAdam 3. Colour rendering CRI>80 oder CRI>90. Stufenlos höhenverstellbare Parallel-Seilabhängung mit transparent ummantelter Zuleitung.

**EN** LED pendant luminaire. Direct-indirect or direct-only light distribution. Luminaire body made of elliptically shaped aluminium profile with 60mm width. Available in 3 sizes, ratio length to width 2:1. Surface white, silver, graphite, black, champagne or copper coated. Further surface options see Lightnet-Surface-Collection or RAL of your choice. Satin opal diffuser for general lighting. Converter integrated into luminaire housing, optionally switchable or dimmable (1-10V, DALI, Touch-Dim, Casambi). Colour temperatures 2200K, 2700K, 3000K, 3500K, 4000K or 6500K. Binning initial  $\leq$  MacAdam 3. Colour rendering CRI>80 or CRI>90. Height-adjustable parallel-cord suspension with transparent power supply cable.

**FR** Luminaire LED suspendu. Éclairage direct/indirect ou seulement direct. Corps du luminaire en forme d'ellipse parfaite en profilé d'aluminium de 60mm de large. Disponible en 3 dimensions, proportions parfaites de longueur pour largeur 2:1 Surface laquée blanc, argent, graphite, noir, champagne ou cuivre. Autres options de finition voir Lightnet-Surface-Collection ou RAL au choix. Diffuseur opale satinée pour un éclairage général. Driver intégré dans le luminaire, au choix ON/OFF ou graduable (1-10V, DALI, Touch-Dim, Casambi). Température de couleur 2200K, 2700K, 3000K, 3500K, 4000K ou 6500K. Binning initial  $\leq$  MacAdam 3. Rendu de couleur CRI>80 ou CRI>90. Filin parallèle droit et tendeur rapide réglable avec câble d'alimentation transparent.



**PRODUCT-CODE: Z P3 O S D - 8 30 M - L1500 - K**

PRODUCT FAMILY	- Z Code Zero
TYPE	- P3 Direct-Indirect, G3 Direct Only
OPTICAL SYSTEM	- O Opal
SURFACE FINISH	- W: Snow White, V: Ivory White, S: Radiant Silver, U: Urban Graphite, B: Jet Black, H: Champagne Silver, K: Satin Copper
CONTROL GEAR	- E: On/Off, L: DALI, D: 1-10V, H: Touch-Dim, C: Casambi, U: Separately Dimmable DALI
COLOUR REND.	- 8: CRI>80, 9: CRI>90, F: Full Spectrum
COLOUR TEMP.	- 22: 2200K, 27: 2700K, 30: 3000K, 35: 3500K, 40: 4000K, 65: 6500K, TW: Tunable White 2700-6500K
POWER	- M: Medium Power, H: High Power
SIZE	- Luminaire Length in mm: L1500, L2000, L3000
SUSPENSION	- K: Parallel Suspension
ON REQUEST	- Cable colour Red or Black

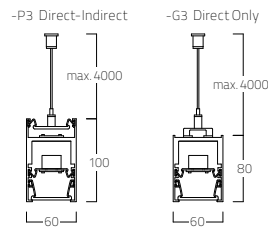

OPAL DIFFUSER / DIRECT-INDIRECT

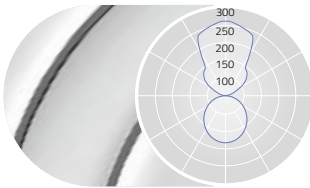

DIRECT: ca.40% INDIRECT ca.60%

OPAL DIFFUSER / DIRECT

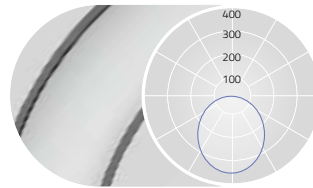

DIRECT: 100%

Length L [mm]	Lumen/Watt Medium Power	Lumen/Watt High Power
1500	17010lm/164W	20320lm/204W
2000	22390lm/218W	26830lm/272W
3000	32640lm/317W	39180lm/397W

Length L [mm]	Lumen/Watt Medium Power	Lumen/Watt High Power
1500	6630lm/88W	8600lm/117W
2000	9180lm/123W	11910lm/164W
3000	13770lm/182W	17860lm/242W

Lumen Values: Luminaire luminous flux at 4000K/CRI>80 / surface finished Snow White. Other configurations on request.



# THREE PEAKS SUSPENDED



CLYDEBANK LEISURE CENTRE, GLASGOW, UK  
THREE PEAKS-P3





THREE PEAKS  
SUSPENDED | G/P



**DE** LED-Pendelleuchte. Rein direkt oder direkt-indirektstrahlend. Leuchtenkörper aus Aluminiumprofil in unterschiedlichen Formen erhältlich. Oberfläche silber, weiß, graphit, schwarz, champagner oder kupferfarben lackiert. Weitere Oberflächenoptionen siehe Lightnet-Surface-Collection oder RAL nach Wahl. Microprismenoptik mit optimierter Blendungsbegrenzung speziell für Office-Anwendungen. Satinierter Opaldiffusor für Allgemeinbeleuchtung. Konverter in Leuchtgehäuse integriert, wahlweise einfach schaltbar oder stufenlos dimmbar (1-10V, DALI, Touch-Dim, Casambi). Farbtemperaturen 2200K, 2700K, 3000K, 3500K, 4000K oder 6500K. Binning initial  $\leq$  MacAdam 3. Farbwiedergabe CRI>80 oder CRI>90. Stufenlos höhenverstellbare Parallelschleife mit transparent ummantelter Zuleitung.

**EN** LED pendant luminaire. Direct only or direct-indirect light distribution. Luminaire body made of aluminium profile available in various shapes. Surface silver, white, graphite, black, champagne or copper coated. Further surface options see Lightnet-Surface-Collection or RAL of your choice. Microprismatic with optimized glare reduction especially for workplaces. Satin opal diffuser for general lighting. Driver integrated into luminaire housing, optionally switchable or dimmable (1-10V, DALI, Touch-Dim, Casambi). Colour temperatures 2200K, 2700K, 3000K, 3500K, 4000K or 6500K. Binning initial  $\leq$  MacAdam 3. Colour rendering CRI>80 or CRI>90. Height-adjustable parallel-cord suspension with transparent power supply cable.

**FR** Luminaire LED suspendu. Éclairage uniquement direct ou direct/indirect. Luminaire triangulaire en profilé aluminium disponible sous différentes formes. Surface laquée argent, blanc, graphite, noir, champagne ou cuivre. Autres options de finition voir Lightnet-Surface-Collection ou RAL au choix. Diffuseur microprismatique optimisé pour un éblouissement limité et adapté aux bureaux. Diffuseur opale satinée pour un éclairage général. Driver intégré dans le luminaire, au choix ON/OFF ou graduable (1-10V, DALI, Touch-Dim, Casambi). Température de couleur 2200K, 2700K, 3000K, 3500K, 4000K ou 6500K. Binning initial  $\leq$  MacAdam 3. Rendu de couleur CRI>80 ou CRI>90. Filin parallèle droit et tendeur rapide réglable avec câble d'alimentation transparent.

G1/P1: OBTUSE

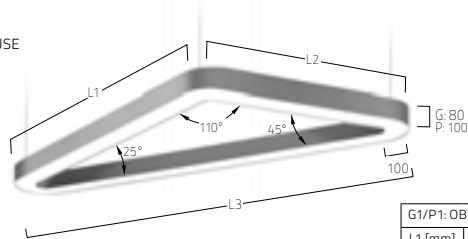

G2/P2: RIGHT ANGLED

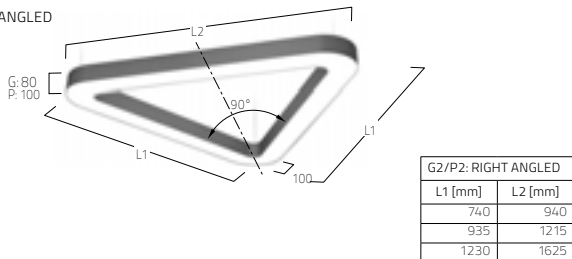

G3/P3: EQUILATERAL

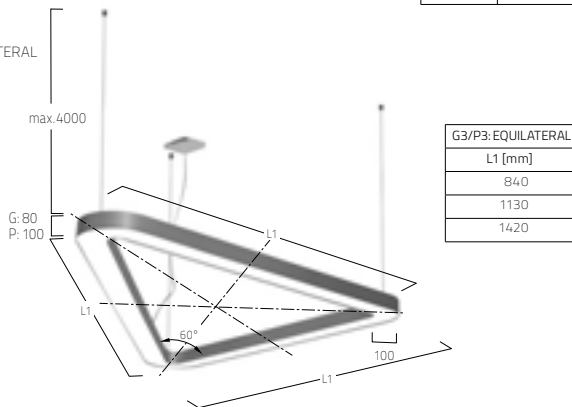

**PRODUCT-CODE:**

**Y P1 A S E - 8 30 M - L930 - K**

PRODUCT FAMILY	- Y: Three Peaks
TYPE	- G1: Obtuse Direct, P1: Obtuse Direct-Indirect G2: Right Angled Direct, P2: Right Angled Direct-Indirect G3: Equilateral Direct, P3: Equilateral Direct-Indirect
OPTICAL SYSTEM	- O: Opal, A: Microprismatic
SURFACE FINISH	- W: Snow White, S: Radiant Silver, U: Urban Graphite, B: Jet Black, H: Champagne Silver, K: Satin Copper
CONTROL GEAR	- E: On/Off, L: DALI, D: 1-10V, H: Touch-Dim, C: Casambi
COLOUR REND.	- 8: CRI>80, 9: CRI>90, F: Full Spectrum
COLOUR TEMP.	- 22: 2200K, 27: 2700K, 30: 3000K, 35: 3500K, 40: 4000K, 65: 6500K
POWER	- M: Medium Power, H: High Power
SIZE	- G1/P1: Luminaire L1 length in mm: L930, L1315, L1615 G2/P2: Luminaire L1 length in mm: L740, L935, L1230 G3/P3: Luminaire L1 length in mm: L840, L1130, L1420
SUSPENSION	- K: Parallel Suspension
ON REQUEST	- Emergency Module, Cable colour Red or Black



MICROPRISMATIC / DIRECT-INDIRECT

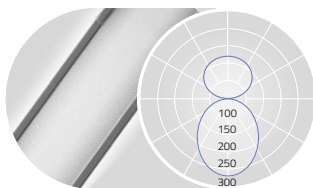

DIRECT: ca. 60% INDIRECT ca. 40%

MICROPRISMATIC / DIRECT

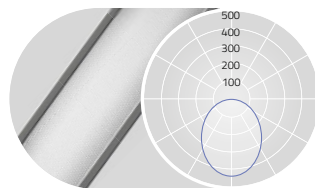

DIRECT: 100%

OPAL DIFFUSER / DIRECT-INDIRECT

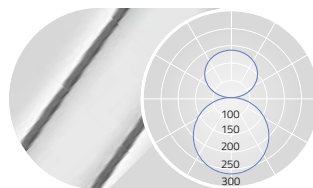

DIRECT: ca. 60% INDIRECT ca. 40%

OPAL DIFFUSER / DIRECT

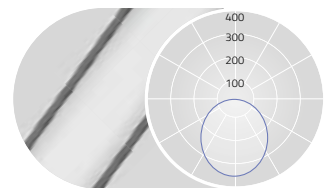

DIRECT: 100%

L1 mm	Lumenlm/Watt Medium Power	Lumenlm/Watt High Power
<b>P1: OBTUSE</b>		
930	11280lm/82W	16380lm/128W
1315	15650lm/111W	22730lm/177W
1615	18780lm/133W	27290lm/209W
<b>P2: RIGHT ANGLED</b>		
740	9420lm/70W	13680lm/110W
935	12700lm/91W	18440lm/143W
1230	17490lm/122W	25390lm/200W
<b>P3: EQUILATERAL</b>		
840	10650lm/77W	15470lm/122W
1130	15170lm/107W	22020lm/166W
1420	19680lm/136W	28570lm/220W

L1 mm	Lumenlm/Watt Medium Power	Lumenlm/Watt High Power
<b>G1: OBTUSE</b>		
930	6810lm/52W	9920lm/84W
1315	9810lm/74W	14290lm/121W
1615	12260lm/92W	17860lm/147W
<b>G2: RIGHT ANGLED</b>		
740	5990lm/46W	8710lm/75W
935	7890lm/60W	11490lm/96W
1230	10620lm/80W	15460lm/130W
<b>G3: EQUILATERAL</b>		
840	6530lm/50W	9510lm/81W
1130	8980lm/68W	13080lm/107W
1420	11440lm/85W	16650lm/138W

L1 mm	Lumenlm/Watt Medium Power	Lumenlm/Watt High Power
<b>P1: OBTUSE</b>		
930	10330lm/82W	15000lm/128W
1315	14290lm/111W	20750lm/177W
1615	17090lm/133W	24820lm/209W
<b>P2: RIGHT ANGLED</b>		
740	8590lm/70W	12470lm/110W
935	11610lm/91W	16850lm/143W
1230	16020lm/122W	23250lm/200W
<b>P3: EQUILATERAL</b>		
840	9750lm/77W	14150lm/122W
1130	13920lm/107W	20210lm/166W
1420	18100lm/136W	26270lm/220W

L1 mm	Lumenlm/Watt Medium Power	Lumenlm/Watt High Power
<b>G1: OBTUSE</b>		
930	5870lm/52W	8550lm/84W
1315	8450lm/74W	12310lm/121W
1615	10570lm/92W	15390lm/147W
<b>G2: RIGHT ANGLED</b>		
740	5160lm/46W	7510lm/75W
935	6800lm/60W	9900lm/96W
1230	9150lm/80W	13320lm/130W
<b>G3: EQUILATERAL</b>		
840	5630lm/50W	8190lm/81W
1130	7740lm/68W	11270lm/107W
1420	9860lm/85W	14350lm/138W

Lumen Values: Luminaire luminous flux at 4000K/CRI>80 / surface finished Snow White. Other configurations on request.

# CALEO INVERSE SUSPENDED

UNITED AIRLINES, HOUSTON, USA  
CALEO-P5





CALEO INVERSE  
SUSPENDED | G3/P3



**DE** LED-Pendelleuchte. Rein direkt oder Direkt-indirektstrahlend. Leuchtenkörper aus Aluminiumprofil. Oberfläche silber, weiß, graphit, schwarz, champagner oder kupferfarben lackiert. Weitere Oberflächenoptionen siehe Lightnet-Surface-Collection oder RAL nach Wahl. Opaldiffusor aus satiniertem Acrylglas für Allgemeinbeleuchtung. Konverter in Leuchtengehäuse integriert, wahlweise einfach schaltbar oder stufenlos dimmbar (1-10V, DALI, Touch-Dim, Casambi). Farbtemperaturen 2200K, 2700K, 3000K, 3500K, 4000K oder 6500K. Binning initial ≤ MacAdam 3. Farbwiedergabe CRI>80 oder CRI>90. Stufenlos höhenverstellbare Parallelseil-Abhängung mit transparent ummantelter Zuleitung, Lackierung Baldachin passend Leuchtenkörper. Lieferung erfolgt als fertig montierbare Einheit für einfache Installation und durchgehend homogene Auflösung der Lichtpunkte. Auf Anfrage: Integration von Notlichtkomponenten, Zuleitungskabel in soft-touch schwarz oder rot.

**EN** LED pendant luminaire. Direct only or direct-indirect light distribution. Luminaire body made of aluminum profile. Surface silver, white, graphite, black, champagne or copper coated. Further surface options see Lightnet-Surface-Collection or RAL of your choice. Opal diffuser made of acrylic glass for general lighting. Converter integrated into luminaire housing, optionally switchable or dimmable (1-10V, DALI, Touch-Dim, Casambi). Colour temperatures 2200K, 2700K, 3000K, 3500K, 4000K or 6500K. Binning initial ≤ MacAdam 3. Colour rendering CRI>80 or CRI>90. Height adjustable Y-cord suspension with transparent power supply cable, colours ceiling rose match to luminaire body. Supplied as a ready-to-mount unit for easy installation and uniform and enhanced light transmission. On request: Integration of emergency lighting components, soft-touch black or red sheathed supply line.

**FR** Luminaire LED suspendu. Éclairage uniquement direct ou direct/indirect. Corps du luminaire en profilé aluminium. Surface laquée argent, blanc, graphite, noir, champagne ou cuivre. Autres options de finition voir Lightnet-Surface-Collection ou RAL au choix. Diffuseur opale en verre acrylique pour éclairage général. Driver intégré dans le luminaire, au choix ON/OFF ou graduable (1-10V, DALI, Touch-Dim, Casambi). Température de couleur 2200K, 2700K, 3000K, 3500K, 4000K ou 6500K. Binning initial ≤ MacAdam 3. Rendu de couleur CRI>80 ou CRI>90. Suspension parallèle réglable en hauteur avec câble d'alimentation transparent, couleur du baldaquin/patère adaptée au corps du luminaire. Livré sous forme d'unité prête au montage pour une installation facile et une résolution homogène et continue des points lumineux. Sur demande: Intégration de composants d'éclairage de secours, câble d'alimentation matière-tissu soft-touch noir ou rouge.

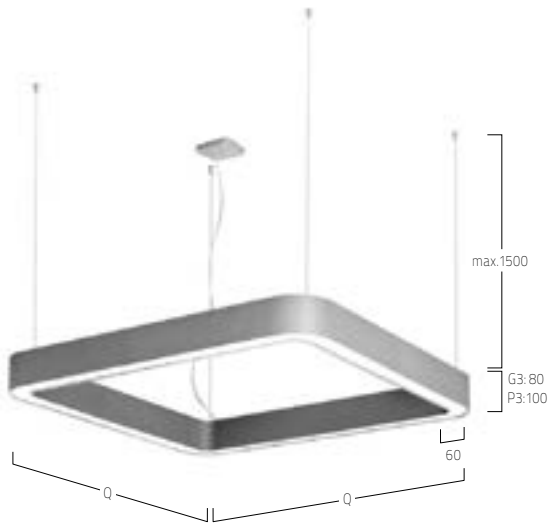

PRODUCT-CODE:	A G 3 O S E - 8 30 M - Q950 - K
PRODUCT FAMILY	A: Caleo
TYPE	G3: Direct Only P3: Direct-Indirect
OPTICAL SYSTEM	A: Microprismatic, O: Opal
SURFACE FINISH	W: Snow White, S: Radiant Silver, U: Urban Graphite, B: Jet Black, H: Champagne Silver, K: Satin Copper
CONTROL GEAR	E: On/Off, L: DALI, D: 1-10V, H: Touch-Dim, C: Casambi,
COLOUR REND.	8: CRI>80, 9: CRI>90, F: Full Spectrum
COLOUR TEMP.	22: 2200K, 27: 2700K, 30: 3000K, 35: 3500K, 40: 4000K, 65: 6500K, TW: Tunable White 2700-6500K
POWER	M: Medium Power, H: High Power
SIZE	Square Size in mm: Q950, Q1245, Q1530
SUSPENSION	K: Parallel Suspension
ON REQUEST	Emergency Module



MICROPRISMATIC / DIRECT-INDIRECT			MICROPRISMATIC / DIRECT			OPAL DIFFUSER / DIRECT-INDIRECT			OPAL DIFFUSER / DIRECT		
DIRECT: ca. 50% INDIRECT ca. 50%			DIRECT: 100%			DIRECT: ca. 40% INDIRECT ca. 60%			DIRECT: 100%		
Q mm	Lumen/Watt Medium Power	Lumen/Watt High Power	Q mm	Lumen/Watt Medium Power	Lumen/Watt High Power	Q mm	Lumen/Watt Medium Power	Lumen/Watt High Power	Q mm	Lumen/Watt Medium Power	Lumen/Watt High Power
950	10160lm/84W	14860lm/133W	950	5000lm/50W	7310lm/81W	950	9340lm/84W	13660lm/133W	950	4180lm/50W	6110lm/81W
1245	14400lm/116W	21070lm/185W	1245	6670lm/66W	9750lm/104W	1245	13310lm/116W	19470lm/185W	1245	5570lm/66W	8150lm/104W
1530	16070lm/131W	23510lm/213W	1530	8340lm/81W	12190lm/132W	1530	14710lm/131W	21510lm/213W	1530	6970lm/81W	10190lm/132W

Lumen Values: Luminaire luminous flux at 4000K/CRI>80 / surface finished Snow White. Other configurations on request.



CALEO LINEAR  
SUSPENDED | G3/R4



**DE** LED-Pendelleuchte. Rein direkt oder Direkt-indirektstrahlend. Leuchtenkörper aus Aluminiumprofil. Oberfläche silber, weiß, graphit, schwarz, champagner oder kupferfarben lackiert. Weitere Oberflächenoptionen siehe Lightnet-Surface-Collection oder RAL nach Wahl. Microprismenoptik mit optimierter Blendungsbegrenzung speziell für Office-Anwendungen. Satinierter Opaldiffusor für Allgemeinbeleuchtung. Konverter in Leuchtengehäuse integriert, wahlweise einfach schaltbar oder stufenlos dimmbar (1-10V, DALI, Touch-Dim, Casambi). Farbtemperaturen 2200K, 2700K, 3000K, 3500K, 4000K oder 6500K. Binning initial  $\leq$  MacAdam 3. Farbwiedergabe CRI>80 oder CRI>90. Stufenlos höhenverstellbare Seil-Abhängung mit transparent ummantelter Zuleitung.

**EN** LED pendant luminaire. Direct only or direct-indirect light distribution. Luminaire body made of aluminium profile. Surface silver, white, graphite, black, champagne or copper coated. Further surface options see Lightnet-Surface-Collection or RAL of your choice. Microprismatic with optimized glare reduction especially for workplaces. Satin opal diffuser for general lighting. Converter integrated into luminaire housing, optionally switchable or dimmable (1-10V, DALI, Touch-Dim, Casambi). Colour temperatures 2200K, 2700K, 3000K, 3500K, 4000K or 6500K. Binning initial  $\leq$  MacAdam 3. Colour rendering CRI>80 or CRI>90. Height-adjustable cord suspension with transparent power supply cable.

**FR** Luminaire LED suspendu. Éclairage uniquement direct ou direct/indirect. Corps du luminaire en profilé aluminium. Surface laquée argent, blanc, graphite, noir, champagne ou cuivre. Autres options de finition voir Lightnet-Surface-Collection ou RAL au choix. Diffuseur microprismatique optimisé pour un éblouissement limité et adapté aux bureaux. Diffuseur opale satinée pour un éclairage général. Driver intégré dans le luminaire, au choix ON/OFF ou graduable (1-10V, DALI, Touch-Dim, Casambi). Température de couleur 2200K, 2700K, 3000K, 3500K, 4000K ou 6500K. Binning initial  $\leq$  MacAdam 3. Rendu de couleur CRI>80 ou CRI>90. Suspension réglable en hauteur avec câble d'alimentation transparent.

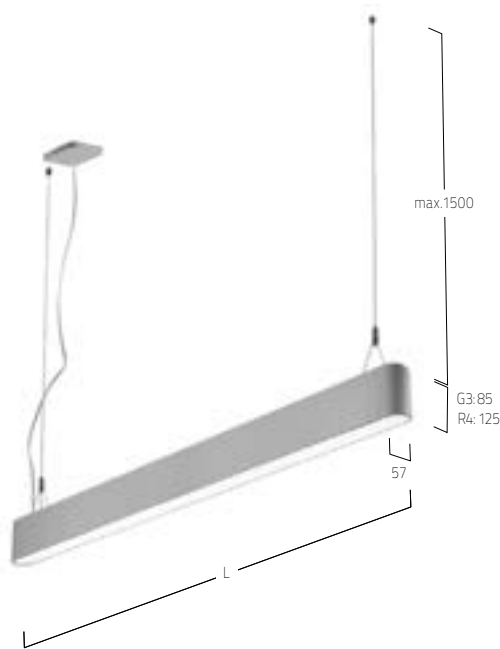

**PRODUCT-CODE:** A G3 O S E - 8 30 M - L894 - Y

PRODUCT FAMILY	- A: Caleo
TYPE	- G3: Direct Only, R4: Direct-Indirect
OPTICAL SYSTEM	- A: Microprismatic, O: Opal Diffuser
SURFACE FINISH	- W: Snow White, S: Radiant Silver, U: Urban Graphite, B: Jet Black, H: Champagne Silver, K: Satin Copper
CONTROL GEAR	- E: On/Off, L: DALI, D: 1-10V, G: Separately Switchable, H: Touch-Dim, C: Casambi
COLOUR REND.	- 8: CRI>80, 9: CRI>90, F: Full Spectrum
COLOUR TEMP.	- 22: 2200K, 27: 2700K, 30: 3000K, 35: 3500K, 40: 4000K, 65: 6500K, TW: Tunable White 2700-6500K
POWER	- M: Medium Power, H: High Power
SIZE	- Luminaire Length in mm: L894 L1182 L1475
SUSPENSION	- Y: Y-Cord Suspension
ON REQUEST	- Emergency Module, Cable colour Red or Black



G3 MICROPRISMATIC

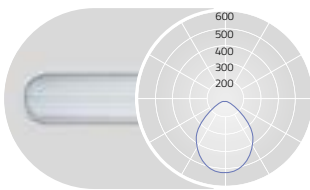

DIRECT: 100%

G3 OPAL

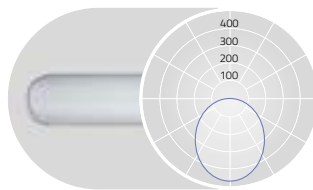

DIRECT: 100%

R4 MICROPRISMATIC

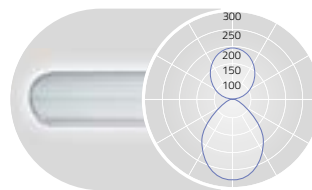

UGR $\leq$ 19 (X=4H, Y=8H, S=0.25H)  
DIRECT: ca.55% INDIRECT: ca.45%

R4 OPAL

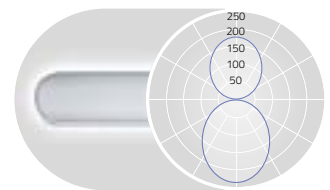

DIRECT: ca.55% INDIRECT: ca.45%

L mm	Lumen/Watt Medium Power	Lumen/Watt High Power
894	1870lm/19W	2720lm/28W
1182	2490lm/24W	3620lm/36W
1475	3110lm/29W	4530lm/44W

L mm	Lumen/Watt Medium Power	Lumen/Watt High Power
894	2080lm/19W	3020lm/28W
1182	2770lm/24W	4030lm/36W
1475	3470lm/29W	5040lm/44W

L mm	Lumen/Watt Medium Power	Lumen/Watt High Power
894	3540lm/33W	5010lm/47W
1182	4790lm/42W	6770lm/61W
1475	6040lm/52W	8540lm/75W

L mm	Lumen/Watt Medium Power	Lumen/Watt High Power
894	3750lm/33W	5310lm/47W
1182	5070lm/42W	7180lm/61W
1475	6400lm/52W	9050lm/75W

Lumen Values: Luminaire luminous flux at 4000K/CRI>80. Other configurations on request.

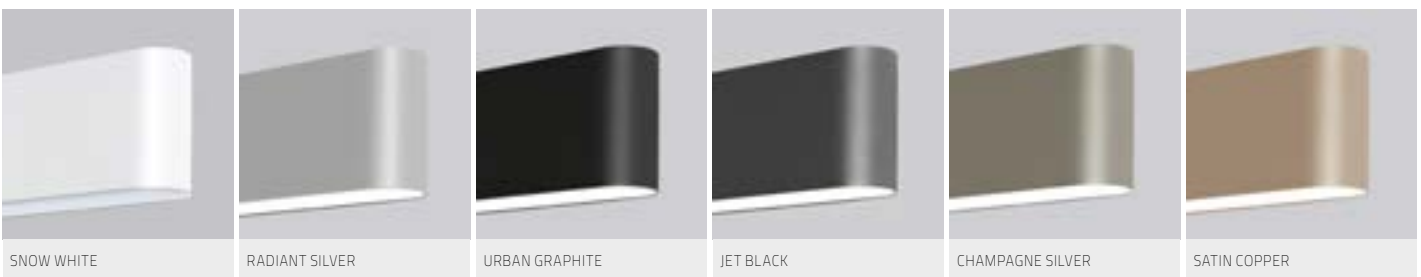



CALEO  
SUSPENDED | G1/P1



**DE** LED-Pendelleuchte. Rein direkt oder Direkt-indirektstrahlend. Leuchtenkörper aus Aluminiumprofil. Oberfläche silber, weiß, graphit, schwarz, champagner oder kupferfarben lackiert. Weitere Oberflächenoptionen siehe Lightnet-Surface-Collection oder RAL nach Wahl. Microprismenoptik mit optimierter Blendungsbegrenzung speziell für Office-Anwendungen. Satinierter Opaldiffusor für Allgemeinbeleuchtung. Indirektenteil mit innovativer Linsentechnologie für breitstrahlende Deckenaufhellung. Konverter in Leuchtengehäuse integriert, wahlweise einfach schaltbar oder stufenlos dimmbar (1-10V, DALI, Touch-Dim, Casambi). Farbtemperaturen 2200K, 2700K, 3000K, 3500K, 4000K oder 6500K. Binning initial  $\leq$  MacAdam 3. Colour rendering CRI>80 oder CRI>90. Stufenlos höhenverstellbare Y-Seilabhängung mit transparent ummantelter Zuleitung. Auf Anfrage: Integration von Notlichtkomponenten, Zuleitungskabel in soft-touch schwarz oder rot.

**EN** LED pendant luminaire. Direct only or direct-indirect light distribution. Luminaire body made of aluminium profile. Surface silver, white, graphite, black, champagne or copper coated. Further surface options see Lightnet-Surface-Collection or RAL of your choice. Microprismatic with optimized glare reduction especially for workplaces. Satin opal diffuser for general lighting. Indirect light with innovative lens technology for wide-angle ceiling illumination. Converter integrated into luminaire housing, optionally switchable or dimmable (1-10V, DALI, Touch-Dim, Casambi). Colour temperatures 2200K, 2700K, 3000K, 3500K, 4000K or 6500K. Binning initial  $\leq$  MacAdam 3. Colour rendering CRI>80 or CRI>90. Height-adjustable Y-cord suspension with transparent power supply cable. On request: Integration of emergency lighting components, soft-touch black or red sheathed supply line.

**FR** Luminaire LED suspendu. Éclairage uniquement direct ou direct/indirect. Corps du luminaire en profilé aluminium. Surface laquée argent, blanc, graphite, noir, champagne ou cuivre. Autres options de finition voir Lightnet-Surface-Collection ou RAL au choix. Diffuseur microprismatique optimisé pour un éblouissement limité et adapté aux bureaux. Diffuseur opale satinée pour un éclairage général. Composants indirects avec une technologie de lentille innovante pour un éclairage grand angle du plafond. Driver intégré dans le luminaire, au choix ON/OFF ou graduable (1-10V, DALI, Touch-Dim, Casambi). Température de couleur 2200K, 2700K, 3000K, 3500K, 4000K ou 6500K. Binning initial  $\leq$  Mac Adam 3. Rendu de couleur CRI>80 ou CRI>90. Suspension en Y réglable en hauteur avec câble d'alimentation transparent. Sur demande: Intégration de composants d'éclairage de secours, câble d'alimentation matière-tissu soft-touch noir ou rouge.

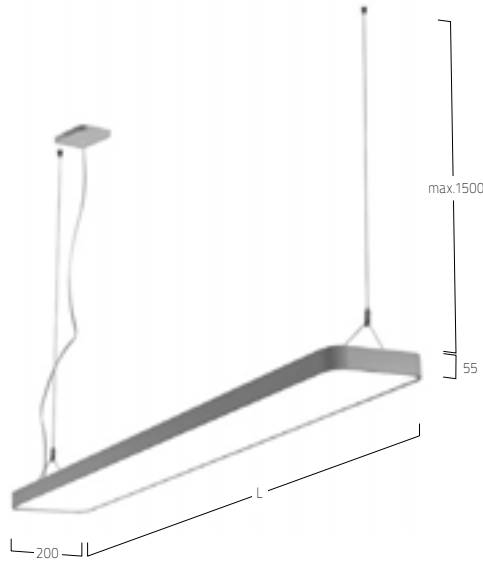

**PRODUCT-CODE:** A P1 O S E - 8 30 M - L900 - Y

PRODUCT FAMILY	- A: Caleo
TYPE	- G1: Direct Only, P1: Direct-Indirect
OPTICAL SYSTEM	- A: Microprismatic, O: Opal Diffuser
SURFACE FINISH	- W: Snow White, S: Radiant Silver, U: Urban Graphite, B: Jet Black, H: Champagne Silver, K: Satin Copper
CONTROL GEAR	- E: On/Off, L: DALI, D: 1-10V, H: Touch-Dim, C: Casambi
COLOUR REND.	- 8: CRI>80, 9: CRI>90
COLOUR TEMP.	- 22: 2200K, 27: 2700K, 30: 3000K, 35: 3500K, 40: 4000K, 65: 6500K, TW: Tunable White 2700-6500K
POWER	- M: Medium Power, H: High Power
SIZE	- Luminaire Length in mm L900, L1200, L1500
SUSPENSION	- Y: Y-Suspension
ON REQUEST	- Emergency Module, Cable colour Red or Black



MICROPRISMATIC / DIRECT-INDIRECT

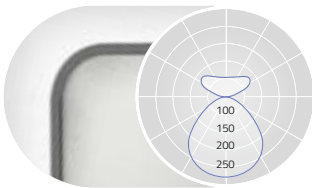

UGR $\leq$ 19 (X=4H, Y=8H, S=0.25H)  
DIRECT: ca. 65% INDIRECT ca. 35%

L mm	Lumen/Watt Medium Power	Lumen/Watt High Power
900	3470lm/30W	4920lm/42W
1200	4620lm/38W	6560lm/55W
1500	5780lm/46W	8210lm/67W

MICROPRISMATIC / DIRECT

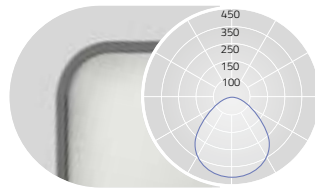

UGR $\leq$ 19 for Medium Power (X=4H, Y=8H, S=0.25H)  
DIRECT: 100%

L mm	Lumen/Watt Medium Power	Lumen/Watt High Power
900	2170lm/18W	3320lm/27W
1200	2890lm/23W	4430lm/36W
1500	3610lm/28W	5540lm/44W

OPAL DIFFUSER / DIRECT-INDIRECT

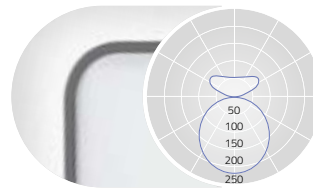

DIRECT: ca. 65% INDIRECT ca. 35%

L mm	Lumen/Watt Medium Power	Lumen/Watt High Power
900	3560lm/30W	5090lm/42W
1200	4750lm/38W	6780lm/55W
1500	5940lm/46W	8480lm/67W

OPAL DIFFUSER / DIRECT

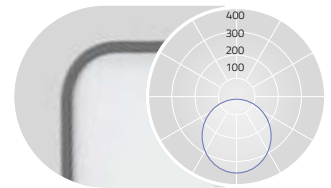

DIRECT: 100%

L mm	Lumen/Watt Medium Power	Lumen/Watt High Power
900	2260lm/18W	3490lm/27W
1200	3020lm/23W	4650lm/36W
1500	3770lm/28W	5810lm/44W

Lumen Values: Luminaire luminous flux at 4000K/CRI>80. Other configurations on request.

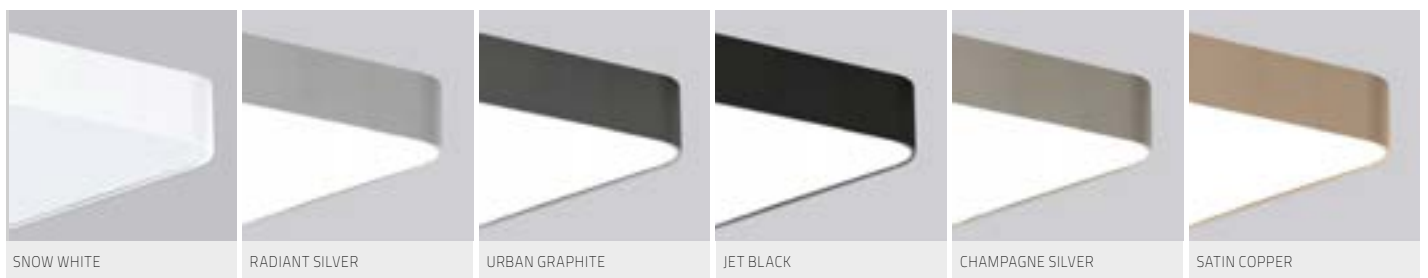

CALEO  
SUSPENDED | G2/P2



**DE** LED-Pendelleuchte. Rein direkt oder Direkt-indirektstrahlend. Leuchtenkörper aus Aluminiumprofil. Oberfläche silber, weiß, graphit, schwarz, champagner oder kupferfarben lackiert. Weitere Oberflächenoptionen siehe Lightnet-Surface-Collection oder RAL nach Wahl. Microprismenoptik mit optimierter Blendungsbegrenzung speziell für Office-Anwendungen. Satinierter Opaldiffusor für Allgemeinbeleuchtung. Konverter in Leuchtgehäuse integriert, wahlweise einfach schaltbar oder stufenlos dimmbar (1-10V, DALI, Touch-Dim, Casambi). Farbtemperaturen 2200K, 2700K, 3000K, 3500K, 4000K oder 6500K. Binning initial  $\leq$  MacAdam 3. Farbwiedergabe CRI>80 oder CRI>90. Stufenlos höhenverstellbare Parallelseil-Abhängung mit transparent ummantelter Zuleitung. Auf Anfrage: Integration von Notlichtkomponenten.

**EN** LED pendant luminaire. Direct only or direct-indirect light distribution. Luminaire body made of aluminium profile. Surface silver, white, graphite, black, champagne or copper coated. Further surface options see Lightnet-Surface-Collection or RAL of your choice. Microprismatic with optimized glare reduction especially for workplaces. Satin opal diffuser for general lighting. Converter integrated into luminaire housing, optionally switchable or dimmable (1-10V, DALI, Touch-Dim, Casambi). Colour temperatures 2200K, 2700K, 3000K, 3500K, 4000K or 6500K. Binning initial  $\leq$  MacAdam 3. Colour rendering CRI>80 or CRI>90. Height-adjustable parallel-cord suspension with transparent power supply cable. On request: Integration of emergency lighting components.

**FR** Luminaire LED suspendu. Éclairage uniquement direct ou direct/indirect. Corps du luminaire en profilé aluminium. Surface laquée argent, blanc, graphite, noir, champagne ou cuivre. Autres options de finition voir Lightnet-Surface-Collection ou RAL au choix. Diffuseur microprismatique optimisé pour un éblouissement limité et adapté aux bureaux. Diffuseur opale satinée pour un éclairage général. Driver intégré dans le luminaire, au choix ON/OFF ou graduable (1-10V, DALI, Touch-Dim, Casambi). Température de couleur 2200K, 2700K, 3000K, 3500K, 4000K ou 6500K. Binning initial  $\leq$  MacAdam 3. Rendu de couleur CRI>80 ou CRI>90. Filin parallèle droit et tendeur rapide réglable avec câble d'alimentation transparent. Sur demande: Intégration de composants d'éclairage de secours

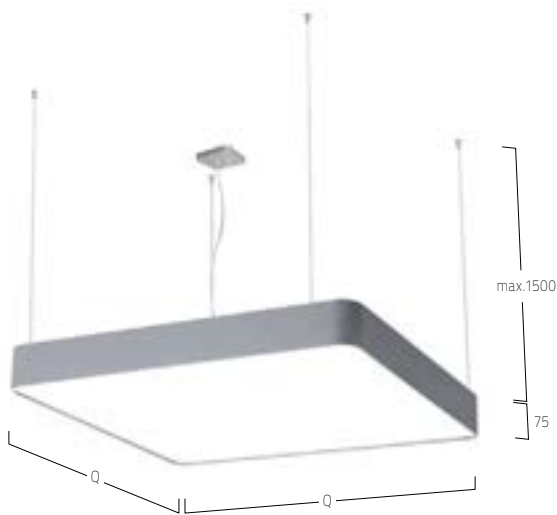

**PRODUCT-CODE: A G2 O S E - 8 30 M - Q900 - K**

PRODUCT FAMILY	- A: Caleo
TYPE	- G2: Direct Only P2: Direct-Indirect
OPTICAL SYSTEM	- A: Microprismatic, O: Opal
SURFACE FINISH	- W: Snow White, S: Radiant Silver, U: Urban Graphite, B: Jet Black, H: Champagne Silver, K: Satin Copper
CONTROL GEAR	- E: On/Off, L: DALI, D: 1-10V, H: Touch-Dim, C: Casambi,
COLOUR REND.	- 8: CRI>80, 9: CRI>90, F: Full Spectrum
COLOUR TEMP.	- 22: 2200K, 27: 2700K, 30: 3000K, 35: 3500K, 40: 4000K, 65: 6500K, TW: Tunable White 2700-6500K
POWER	- M: Medium Power, H: High Power
SIZE	- Square Size in mm: Q330, Q430, Q530, Q630, Q900
SUSPENSION	- K: Parallel Suspension
ON REQUEST	- Emergency Module, Radar Sensor, Cable colour Red or Black

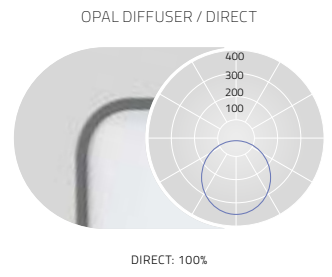
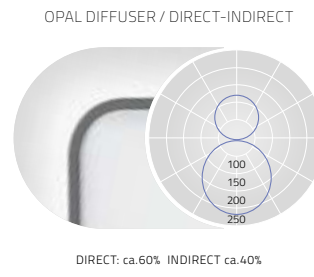
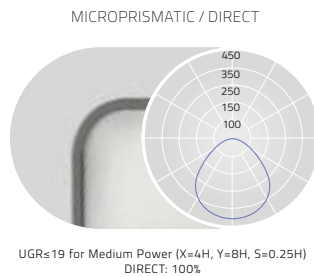
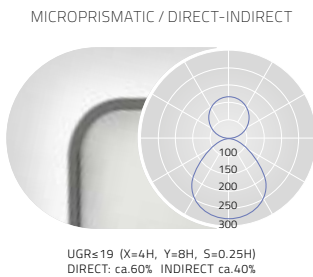

Q mm	Lumen/Watt Medium Power	Lumen/Watt High Power
330	2470lm/19W	3640lm/28W
430	4360lm/31W	6300lm/45W
530	6000lm/40W	11170lm/80W
630	9610lm/68W	14270lm/103W
900	11790lm/96W	19040lm/173W

Q mm	Lumen/Watt Medium Power	Lumen/Watt High Power
330	1360lm/12W	2010lm/18W
430	2370lm/20W	3450lm/29W
530	3630lm/27W	6790lm/51W
630	5200lm/40W	8500lm/65W
900	7910lm/67W	13240lm/129W

Q mm	Lumen/Watt Medium Power	Lumen/Watt High Power
330	2510lm/19W	3700lm/28W
430	4430lm/31W	6400lm/45W
530	6110lm/40W	11370lm/80W
630	9770lm/68W	14530lm/103W
900	12030lm/96W	19440lm/173W

Q mm	Lumen/Watt Medium Power	Lumen/Watt High Power
330	1400lm/12W	2070lm/18W
430	2440lm/20W	3550lm/29W
530	3740lm/27W	6990lm/51W
630	5360lm/40W	8760lm/65W
900	8150lm/67W	13640lm/129W

Lumen Values: Luminaire luminous flux at 4000K/CRI>80 / surface finished Snow White. Other configurations on request.



# CUBIC SUSPENDED



VITRA TYPECASTING, MILAN DESIGN WEEK  
CUBIC-P2





AXEPT BUSINESS SOFTWARE AG,  
KEMPTTHAL, SCHWITZERLAND  
CUBIC-P5

PLANNING: ERNST, VON PETERSDORFF + PARTNER AG  
CONCEPT: PI ID AG  
REALIZATION: MABALUX AG

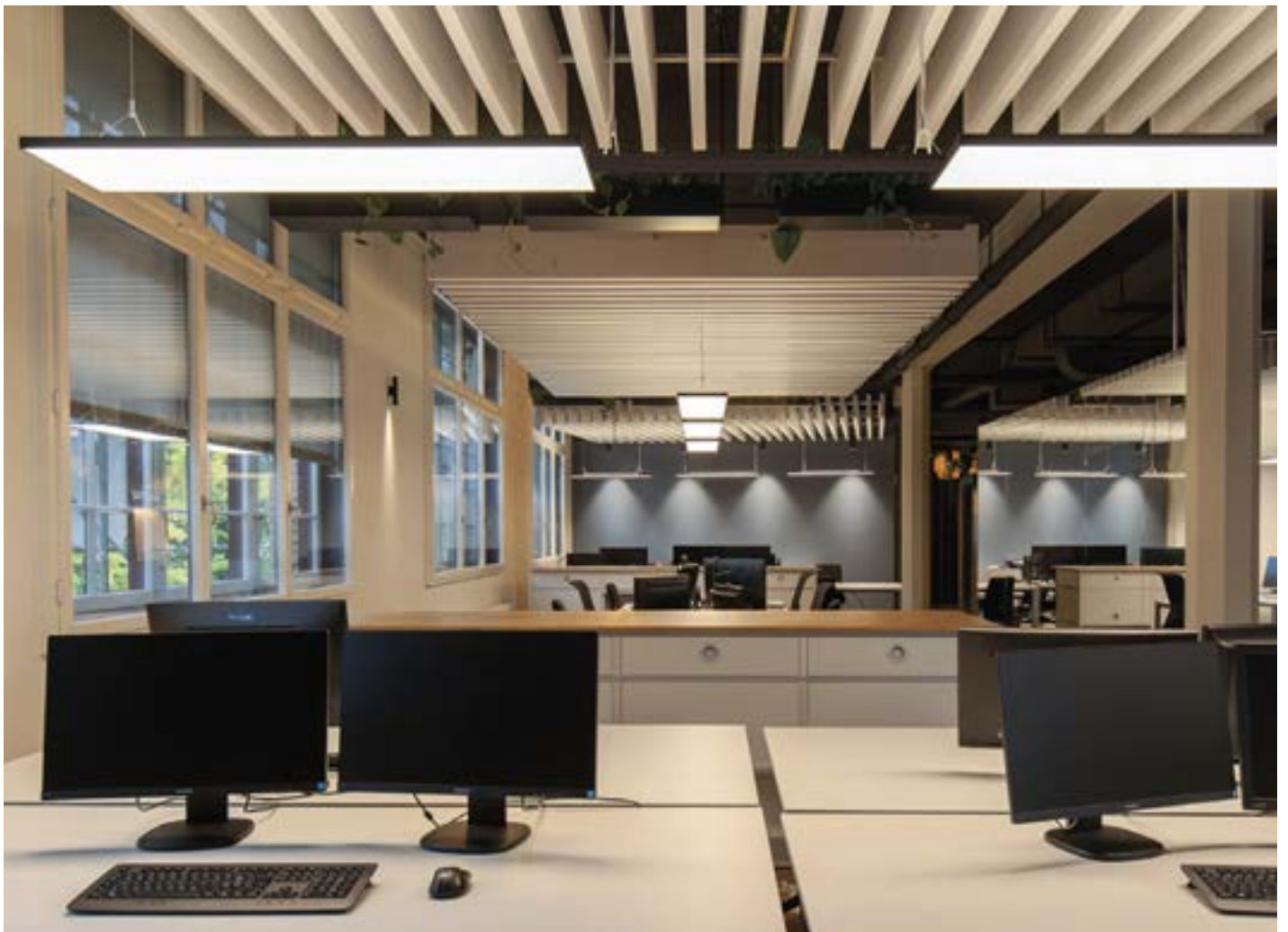

CUBIC EVOLUTION  
SUSPENDED | G4/P4

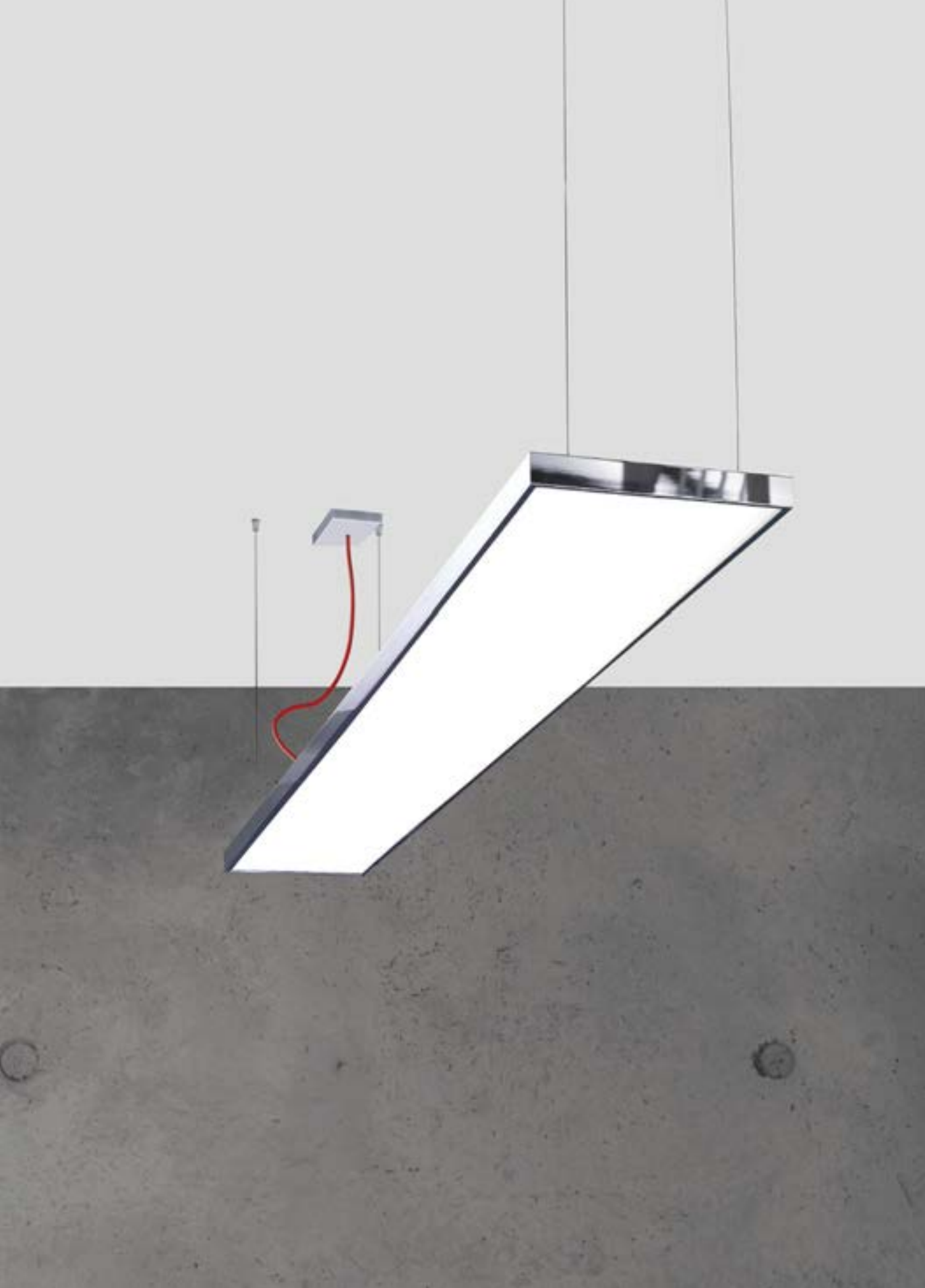

**DE** LED-Pendelleuchte. Direkt-indirekt oder rein direktstrahlend. Leuchtenkörper in minimalistischer Bauhöhe aus Aluminiumprofil. Oberfläche nature-oxidiert oder weiß, graphit, schwarz bzw. champagnerfarben lackiert sowie Alu poliert. Weitere Oberflächeoptionen siehe Lightnet-Surface-Collection oder RAL nach Wahl. Microprismenoptik mit optimierter Blendungsbegrenzung speziell für Office-Anwendungen. Satinierter Opaldiffusor für Allgemeinbeleuchtung mit max. Transmissionsgrad und homogener Lichtpunkt-auflösung. Indirektanteil mit innovativer Linsentechnologie für breitstrahlende Deckenaufhellung. Konverter in Leuchtgehäuse integriert, wahlweise einfach schaltbar oder stufenlos dimmbar (1-10V, DALI, Touch-Dim, Casambi). Farbtemperaturen 2700K, 3000K, 3500K oder 4000K. Binning initial  $\leq$  MacAdam 3. Farbwiedergabe CRI>80 oder CRI>90. Stufenlos höhenverstellbare Y-Seil- oder Parallel-Seilabhängung mit transparent ummantelter Zuleitung. Auf Anfrage: Integration von Notlichtkomponenten, Sensortechnologie, Zuleitungskabel in soft-touch schwarz oder rot.

**EN** LED pendant luminaire. Direct-indirect or Direct Only light distribution. Luminaire body with minimalist overall height made of aluminium profile. Surface natural anodised or white, graphite, black or champagne coated as well as polished aluminium. Further surface options see Lightnet-Surface-Collection or RAL of your choice. Microprismatic with optimized glare reduction especially for workplaces. Satin opal diffuser for general lighting with maximum transmittance and homogeneous lighting. Indirect light with innovative lens technology for wide-angle ceiling illumination. Converter integrated into luminaire housing, optionally switchable or dimmable (1-10V, DALI, Touch-Dim, Casambi). Colour temperature 2700K, 3000K, 3500K or 4000K. Binning initial  $\leq$  MacAdam 3. Colour rendering CRI>80 or CRI>90. Height adjustable Y-cord suspension or parallel-cord suspension with transparent power supply cable. On request: Integration of emergency lighting components, sensor technology, soft-touch black or red sheathed supply line.

**FR** Luminaire LED suspendu. Éclairage direct/indirect ou seulement direct. Corps du luminaire en profilé aluminium et épaisseur minimaliste. Surface anodisée ou laquée blanc, graphite, noir, champagne ou polie. Autres options de finition voir Lightnet-Surface-Collection ou RAL au choix. Diffuseur microprismatique optimisé pour un éblouissement limité et adapté aux bureaux. Diffuseur opale satiné pour un éclairage général et une transmission maximale et homogène. Composants indirects avec une technologie de lentille innovante pour un éclairage grand angle du plafond. Driver intégré dans le luminaire, au choix ON/OFF ou graduable (1-10V, DALI, Touch-Dim, Casambi). Température de couleur 2700K, 3000K, 3500K ou 4000K. Binning initial  $\leq$  MacAdam 3. Rendu de couleur CRI>80 ou CRI>90. Filin et tendeur rapide réglable en Y ou filin parallèle droit avec câble d'alimentation transparent. Sur demande: Intégration de batterie de secours, technologie de sensor /cellule, câble d'alimentation matière-tissu soft-touch noir ou rouge.



**PRODUCT-CODE:** C P4 A B E - 8 30 M - L900 - Y

- PRODUCT FAMILY - C: Cubic
- TYPE - P4: Suspended Direct-Indirect  
G4: Suspended Direct Only
- OPTICAL SYSTEM - A: Microprismatic, O: Opal Diffuser
- SURFACE FINISH - W: Snow White, E: Silver Anodised, U: Urban Graphite,  
B: Jet Black, H: Champagne Silver, P: Polished Aluminium
- CONTROL GEAR - E: On/Off, L: DALI, D: 1-10V, H: Touch-Dim, C: Casambi
- COLOUR REND. - 8: CRI>80, 9: CRI>90
- COLOUR TEMP. - 27: 2700K, 30: 3000K, 35: 3500K, 40: 4000K,  
TW: Tunable White 2700-6500K
- POWER - M: Medium Power, H: High Power
- SIZE - Luminaire Length in mm L900, L1200, L1500
- SUSPENSION - Y: Y-Cord Suspension, K: 4-Cord Suspension
- ON REQUEST - Emergency Module, Multisensor, Cable colour: Red, Black



MICROPRISMATIC / DIRECT-INDIRECT

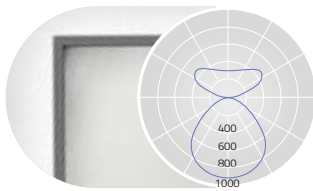

UGR $\leq$ 19 (X=4H, Y=8H, S=0.25H)  
DIRECT: ca.60% INDIRECT ca.40%

L mm	Lumen/Watt Medium Power	Lumen/Watt High Power
900	3990lm/33W	5010lm/42W
1200	5170lm/43W	6490lm/55W
1500	6400lm/53W	8000lm/68W

MICROPRISMATIC / DIRECT



UGR $\leq$ 19 for Medium Power (X=4H, Y=8H, S=0.25H)  
DIRECT: 100%

L mm	Lumen/Watt Medium Power	Lumen/Watt High Power
900	2330lm/19W	2990lm/26W
1200	2960lm/26W	3800lm/33W
1500	3640lm/32W	4630lm/41W

OPAL DIFFUSER / DIRECT-INDIRECT

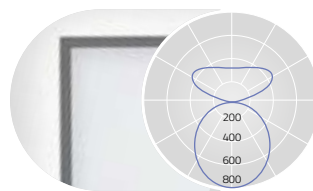

DIRECT: ca.60% INDIRECT ca.40%

L mm	Lumen/Watt Medium Power	Lumen/Watt High Power
900	3780lm/33W	4730lm/42W
1200	5000lm/43W	6240lm/55W
1500	6110lm/53W	7630lm/68W

OPAL DIFFUSER / DIRECT

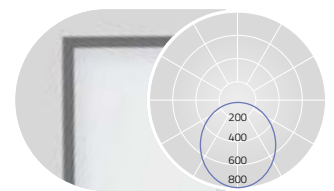

DIRECT: 100%

L mm	Lumen/Watt Medium Power	Lumen/Watt High Power
900	2120lm/19W	2710lm/26W
1200	2790lm/26W	3550lm/33W
1500	3350lm/32W	4260lm/41W

Lumen Values: Luminaire luminous flux at 4000K/CRI>80. Other configurations on request.



MULTISENSOR CONTROL

EMERGENCY MODULE



SNOW WHITE

SILVER ANODISED

URBAN GRAPHITE

JET BLACK

CHAMPAGNE SILVER

POLISHED ALUMINIUM



# CUBIC EVOLUTION SYSTEM SUSPENDED | G4/P4



**DE** LED-System-Pendelleuchte. Direkt-indirekt oder rein direktstrahlend. Leuchtenkörper aus Aluminiumprofil. Oberfläche naturelxiert oder weiß, graphit, schwarz bzw. champagnerfarben lackiert sowie Alu poliert. Weitere Oberflächenoptionen siehe Lightnet-Surface-Collection oder RAL nach Wahl. Microprismenoptik mit optimierter Blendungsbegrenzung speziell für Office-Anwendungen. Satinierter Opaldiffusor für Allgemeinbeleuchtung mit max. Transmissionsgrad und homogener Lichtpunktauflösung. Indirektanteil mit innovativer Linsentechnologie für breitstrahlende Deckenaufhellung. Konverter in Leuchtengehäuse integriert, wahlweise einfach schaltbar oder stufenlos dimmbar (1-10V, DALI, Touch-Dim, Casambi). Farbtemperaturen 3000K oder 4000K. Binning initial  $\leq$  MacAdam 3. Farbwiedergabe CRI>80 oder CRI>90. Stufenlos höhenverstellbare Y-Seil- oder Parallel-Seilabhängung mit transparent, rot oder schwarz ummantelter Zuleitung. Lackierung Baldaquin passend Leuchtenkörper. Auf Anfrage: Integration von Notlichtkomponenten, Sensortechnologie, Zuleitungskabel in soft-touch schwarz oder rot.

**EN** LED pendant light system. Direct-indirect or Direct Only light distribution. Luminaire body made of aluminum profile. Surface natural anodised or white, graphite, black or champagne coated as well as polished aluminium. Further surface options see Lightnet-Surface-Collection or RAL of your choice. Microprismatic with optimized glare reduction especially for workplaces. Satin opal diffuser for general lighting with maximum transmittance and homogeneous lighting. Indirect light with innovative lens technology for wide-angle ceiling illumination. Converter integrated into luminaire housing, optionally switchable or dimmable (1-10V, DALI, Touch-Dim, Casambi). Colour temperature 3000K or 4000K. Binning initial  $\leq$  MacAdam 3. Colour rendering CRI>80 or CRI>90. Height adjustable Y-cord suspension or parallel-cord suspension with transparent, red or black sheathed supply line. Colour of ceiling rose matching luminaire body. On request: Integration of emergency lighting components, sensor technology, soft-touch black or red sheathed supply line.

**FR** Système d'éclairage LED suspendu. Éclairage direct/indirect ou seulement direct. Corps du luminaire en profilé aluminium. Surface anodisée ou laquée blanc, graphite, noir, champagne ou polie. Autres options de finition voir Lightnet-Surface-Collection ou RAL au choix. Diffuseur microprismatique optimisé pour un éblouissement limité et adapté aux bureaux. Diffuseur opale satiné pour un éclairage général et une transmission maximale et homogène. Composants indirects avec une technologie de lentille innovante pour un éclairage grand angle du plafond. Driver intégré dans le luminaire, au choix ON/OFF ou graduable (1-10V, DALI, Touch-Dim, Casambi). Température de couleur 3000K ou 4000K. Binning initial  $\leq$  MacAdam 3. Rendu de couleur CRI>80 ou CRI>90. Filin et tendeur rapide réglable en Y ou filin parallèle droit avec câble d'alimentation transparent, ou de matière-tissu rouge ou noir. Couleur du baldaquin /patère adaptée au corps du luminaire. Sur demande: Intégration de batterie de secours, technologie de sensor/cellule, câble d'alimentation matière-tissu soft-touch noir ou rouge.

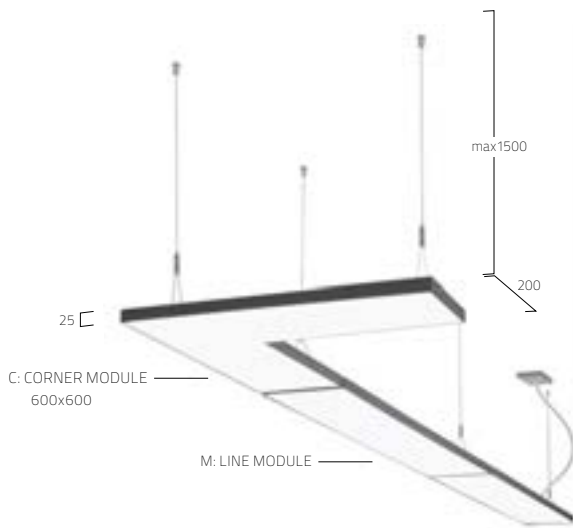

**PRODUCT-CODE:** C P4 A B E - 8 30 M - M900 - Y

PRODUCT FAMILY	- C: Cubic
TYPE	- P4: Suspended Direct-Indirect G4: Suspended Direct Only
OPTICAL SYSTEM	- A: Microprismatic, O: Opal Diffuser
SURFACE FINISH	- W: Snow White, E: Silver Anodised, U: Urban Graphite, B: Jet Black, H: Champagne Silver, P: Polished Aluminium
CONTROL GEAR	- E: On/Off, L: DALI, D: 1-10V, H: Touch-Dim, C: Casambi
COLOUR REND.	- 8: CRI>80, 9: CRI>90
COLOUR TEMP.	- 27: 2700K, 30: 3000K, 35: 3500K, 40: 4000K, TW: Tunable White 2700-6500K
POWER	- M: Medium Power, H: High Power
SHAPE	- Line Module: M900, M1200, M1500 Corner Module: C600
SUSPENSION	- Y: Y-Cord Suspension, K: 4-Cord Suspension
ON REQUEST	- Emergency Module, Multisensor

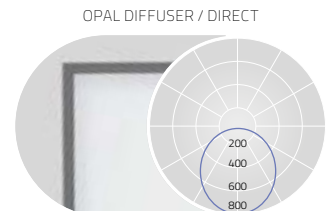
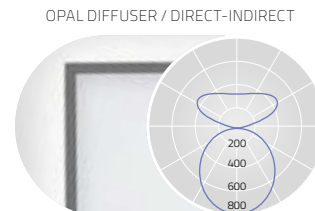
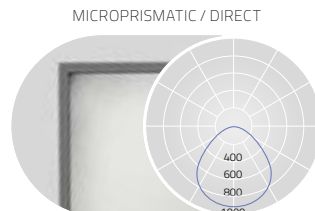
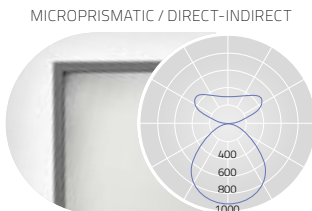

UGR $\leq 19$  (X=4H, Y=8H, S=0.25H)  
DIRECT: ca.60% INDIRECT ca.40%

C mm	Lumen/Watt Medium Power	Lumen/Watt High Power
600x600	4070lm/35W	5110lm/45W

UGR $\leq 19$  for Medium Power (X=4H, Y=8H, S=0.25H)  
DIRECT: 100%

C mm	Lumen/Watt Medium Power	Lumen/Watt High Power
600x600	2410lm/22W	3060lm/29W

DIRECT: ca.60% INDIRECT ca.40%

C mm	Lumen/Watt Medium Power	Lumen/Watt High Power
600x600	4010lm/35W	5030lm/45W

DIRECT: 100%

C mm	Lumen/Watt Medium Power	Lumen/Watt High Power
600x600	2360lm/22W	2980lm/29W

Lumen Values: Luminaire luminous flux at 4000K/CRI>80. Other configurations on request.

EDGE TO EDGE STRAIGHT CONNECTOR WITH SUSPENSION



STRAIGHT CONNECTOR 20MM WITH SUSPENSION

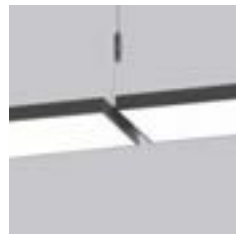

STRAIGHT CONNECTOR 300MM WITH SUSPENSION

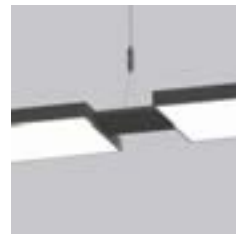

STRAIGHT CONNECTOR 500MM WITH SUSPENSION

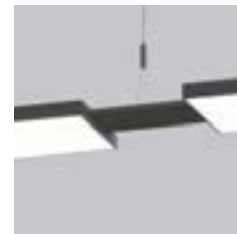

Code	Connector Length	Surface Finish	Susp. Type
S	Connector	L00	W
S	Connector	L20	W
S	Connector	L300	W
S	Connector	L500	W

CORNER CONNECTOR WITH SUSPENSION



CANOPY + POWER SUPPLY CABLE



Code	Corner Length	Surface Finish	Susp. Type
C	Connector	L170X170	W

Code	Cable Length	Surface Finish	Cable Type
X	Canopy	L1500	W

SURFACE FINISH:

- W Snow White
- E Silver Anodised [Not available for Canopy]
- U Urban Graphite
- B Jet Black
- H Champagne Silver
- P Polished Aluminium [Not available for Canopy]

SUSPENSION TYPE:

- Y Y-Cord Suspension
- K 4-Cord Suspension

CABLE TYPE:

- 5 5x 0,75mm<sup>2</sup>, Transparent cable

# CUBIC EVOLUTION SUSPENDED | U4



**DE** LED-Pendelleuchte. Rein indirektstrahlend. Leuchtenkörper in minimalistischer Bauhöhe aus Aluminiumprofil. Oberfläche natureloxiert oder weiß, graphit, schwarz bzw. champagnerfarben lackiert sowie Alu poliert. Weitere Oberflächenoptionen siehe Lightnet-Surface-Collection oder RAL nach Wahl. Konverter in Leuchtgehäuse integriert, wahlweise einfach schaltbar oder stufenlos dimmbar (1-10V, DALI, Touch-Dim). Farbtemperaturen 2700K, 3000K, 3500K oder 4000K. Binning initial  $\leq$  MacAdam 3. Farbwiedergabe CRI>80 oder CRI>90. Stufenlos höhenverstellbare Y-Seil- oder Parallel-Seilabhängung mit transparent ummantelter Zuleitung. Auf Anfrage: Integration von einzelnen Midpin Spotlights nach Vorgabe oder von 3-Phasen-Stromschienen für akzentuiertes direktes Licht.

**EN** LED pendant luminaire. Indirect only light distribution. Luminaire body with minimalistic overall height made of aluminium profile. Surface natural anodised or white, graphite, black or champagne coated as well as polished aluminium. Further surface options see Lightnet-Surface-Collection or RAL of your choice. Driver integrated into luminaire housing, optionally switchable or dimmable (1-10V, DALI, Touch-Dim). Colour temperature 2700K, 3000K, 3500K or 4000K. Binning initial  $\leq$  MacAdam 3. Colour rendering CRI>80 or CRI>90. Height adjustable Y-cord suspension or parallel-cord suspension with transparent power supply cable. On request: Integration of single Midpin spotlights according to specifications or 3-phase tracks for accentuated direct light.

**FR** Luminaire LED suspendu. Éclairage seulement indirect. Corps du luminaire en profilé aluminium et épaisseur minimaliste. Surface anodisée ou laquée blanc, graphite, noir, champagne ou polie. Autres options de finition voir Lightnet-Surface-Collection ou RAL au choix. Driver intégré dans le luminaire, au choix ON/OFF ou graduable (1-10V, DALI, Touch-Dim). Température de couleur 2700K, 3000K, 3500K ou 4000K. Binning initial  $\leq$  MacAdam 3. Rendu de couleur CRI>80 ou CRI>90. Filin et tendeur rapide réglable en Y ou filin parallèle droit avec câble d'alimentation transparent. Sur demande: Intégration de spot Midpin individuel selon les spécifications ou de rails triphasés pour une lumière directe accentuée.

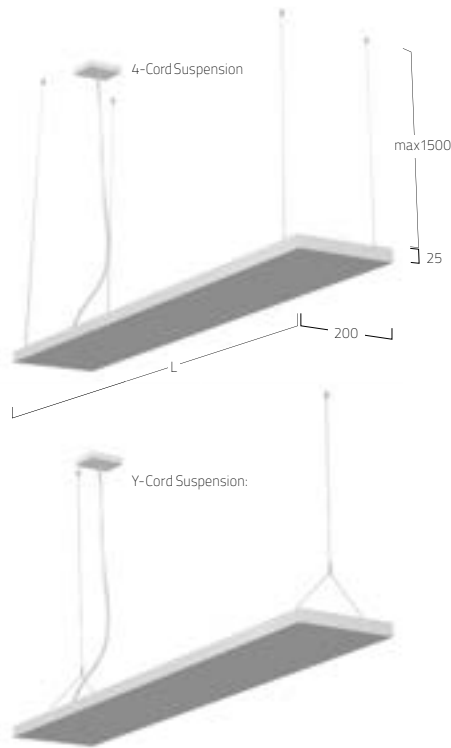

**PRODUCT-CODE: C U4 U B E - 8 30 M - L900 - Y**

PRODUCT FAMILY	- C: Cubic
TYPE	- U4: Suspended Indirect Only
OPTICAL SYSTEM	- U: Indirect Optic
SURFACE FINISH	- W: Snow White, E: Silver Anodised, U: Urban Graphite, B: Jet Black, H: Champagne Silver
CONTROL GEAR	- E: On/Off, L: DALI, D: 1-10V, H: Touch-Dim
COLOUR REND.	- 8: CRI>80, 9: CRI>90
COLOUR TEMP.	- 27: 2700K, 30: 3000K, 35: 3500K, 40: 4000K, TW: Tunable White 2700-6500K
POWER	- M: Medium Power, H: High Power
SIZE	- Luminaire Length in mm L900, L1200, L1500, L1800, L2100
SUSPENSION	- Y: Y-Cord Suspension, K: 4-Cord Suspension
ON REQUEST	- Integration of Midpin Spotlights, Integration of 3-Phase Track, Cable colour: Red, Black



INDIRECT OPTIC

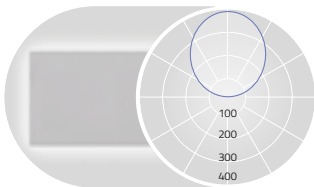

INDIRECT 100%

L mm	Lumen/Watt Medium Power	Lumen/Watt High Power
900	4300lm/32W	5570lm/43W
1200	5730lm/41W	7430lm/55W
1500	7170lm/50W	9280lm/67W
1800	8600lm/59W	11140lm/79W
2100	10030lm/73W	12990lm/98W

Lumen Values: Luminaire luminous flux at 4000K/CRI>80. Other configurations on request.



INTEGRATION OF MIDPIN SPOTLIGHTS

INTEGRATION OF 3-PHASE TRACK



# CUBIC EVOLUTION SUSPENDED | R4



**DE** LED-Pendelleuchte. Direkt-indirektstrahlend. Leuchtenkörper in minimalistischer Bauhöhe aus Aluminiumprofil. Oberfläche natureloxiert oder weiß, graphit, schwarz bzw. champagnerfarben lackiert sowie Alu poliert. Weitere Oberflächenoptionen siehe Lightnet-Surface-Collection oder RAL nach Wahl. Direktanteil über Präzisionslinsen mit Abblendraster für breite rotationssymmetrische Lichtstärkeverteilung bei gleichzeitig hoher Blendungsbegrenzung (UGR<16). Raster in verschiedenen Farbkombinationen erhältlich. Indirektanteil mit innovativer Linsentechnologie für breitstrahlende Deckenaufhellung. Konverter in Leuchtengehäuse integriert, wahlweise einfach schaltbar oder stufenlos dimmbar (1-10V, DALI, Touch-Dim). Farbtemperaturen 2700K, 3000K, 3500K oder 4000K. Binning initial  $\leq$  Mac Adam 3. Farbwiedergabe CRI>80 oder CRI>90. Stufenlos höhenverstellbare Y-Seil- oder Parallel-Seilabhängung mit transparent ummantelter Zuleitung, Lackierung Baldachin passend Leuchtenkörper. Auf Anfrage: Zuleitungskabel in soft-touch schwarz oder rot.

**EN** LED pendant luminaire. Direct-indirect light distribution. Luminaire body with minimalistic overall height made of aluminium profile. Surface natural anodised or white, graphite, black or champagne coated as well as polished aluminium. Further surface options see Lightnet-Surface-Collection or RAL of your choice. Direct part using precision lenses with louvre for wide rotationally symmetrical light distribution with high glare limitation (UGR<16). Louvre available in various colour combinations. Indirect light with innovative lens technology for wide-angle ceiling illumination. Converter integrated into luminaire housing, optionally switchable or dimmable (1-10V, DALI, Touch-Dim). Colour temperature 2700K, 3000K, 3500K or 4000K. Binning initial  $\leq$  Mac Adam 3. Colour rendering CRI>80 or CRI>90. Height adjustable Y-cord suspension or parallel-cord suspension with transparent power supply cable, colour of ceiling rose matching luminaire body. On request: Soft-touch black or red sheathed supply line.

**FR** Luminaire LED suspendu. Éclairage direct/indirect. Corps du luminaire en profilé aluminium et épaisseur minimaliste. Surface anodisée ou laquée blanc, graphite, noir, champagne ou polie. Autres options de finition voir Lightnet-Surface-Collection ou RAL au choix. Éclairage direct partiel par lentilles de précision avec grille anti-éblouissement pour une large répartition symétrique de l'intensité lumineuse et facteur d'anti-éblouissement très bas (UGR<16). Grille anti-éblouissement disponible en plusieurs combinaisons de couleurs. Composants indirects avec une technologie de lentille innovante pour un éclairage grand angle du plafond. Driver intégré dans le luminaire, au choix ON/OFF ou graduable (1-10V, DALI, Touch-Dim). Température de couleur 2700K, 3000K, 3500K ou 4000K. Binning initial  $\leq$  Mac Adam 3. Rendu de couleur CRI>80 ou CRI>90. Filin et tendeur rapide réglable en Y ou filin parallèle droit avec câble d'alimentation transparent, couleur baldachin/patère adaptée au corps du luminaire. Sur demande: Câble d'alimentation en matière-tissu soft-touch noir ou rouge.

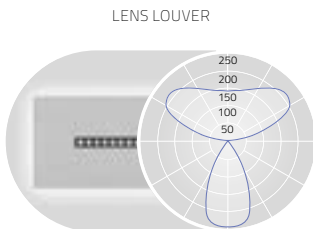
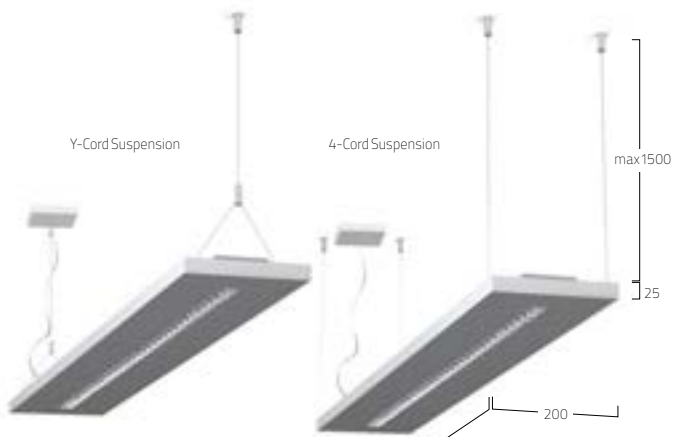

UGR $\leq$ 10 for Medium Power (X=4H, Y=8H, S=0.25H)  
DIRECT: ca.30% INDIRECT ca.70%

L mm	Lumen/Watt Medium Power	Lumen/Watt High Power
640	3320lm/27W	4770lm/40W
925	5310lm/41W	7620lm/62W
1210	7300lm/56W	10480lm/84W

Lumen Values: Luminaire luminous flux at 4000K/CRI>80. Other configurations on request.

**PRODUCT-CODE:** C R4 L B E - 8 30 M - L925 - Y B

- PRODUCT FAMILY – C: Cubic
- TYPE – R4: Suspended Direct-Indirect
- OPTICAL SYSTEM – L: Lens Louver
- SURFACE FINISH – W: Snow White, E: Silver Anodised, U: Urban Graphite, B: Jet Black, H: Champagne Silver
- CONTROL GEAR – E: On/Off, L: DALI, D: 1-10V, H: Touch-Dim,
- COLOUR REND. – 8: CRI>80
- COLOUR TEMP. – 27: 2700K, 30: 3000K, 40: 4000K
- POWER – M: Medium Power, H: High Power
- SIZE – Luminaire Length in mm L640, L925, L1210
- SUSPENSION – Y: Y-Cord Suspension, K: 4-Cord Suspension
- REFLECTOR – W: Snow White, C: Specular Chrome, B: Jet Black, A: Satin Silver, H: Champagne Silver, K: Satin Copper, N: Satin Platinum, G: Satin Gold
- ON REQUEST – Cable colour: Red, Black

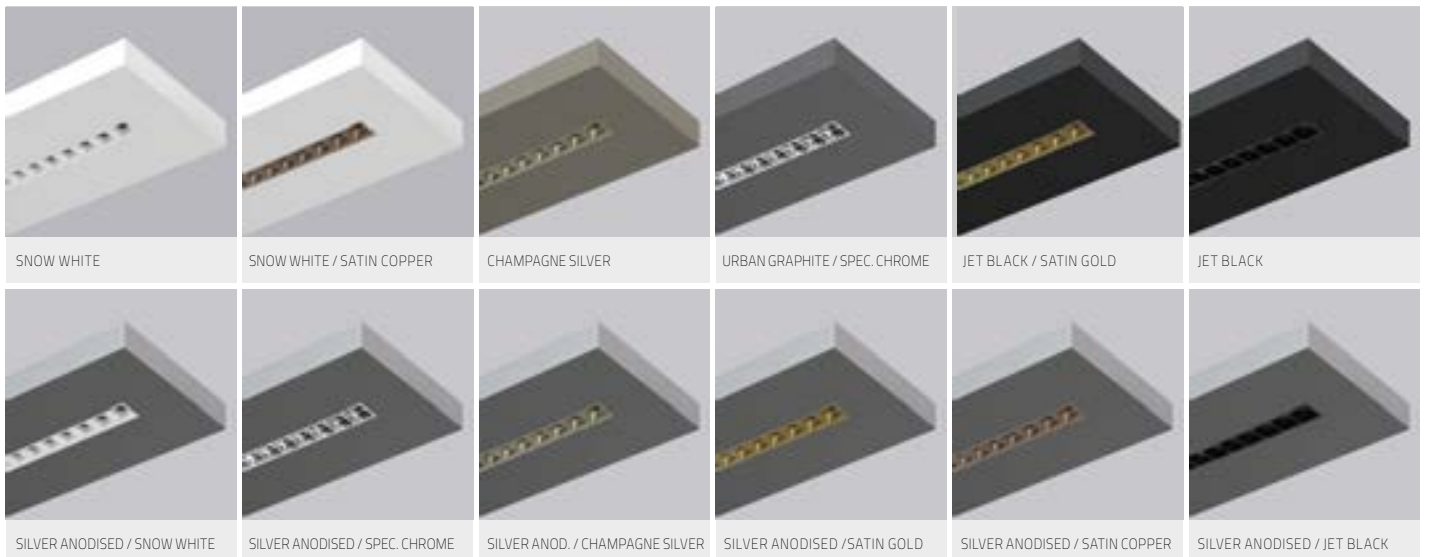

CUBIC EVOLUTION  
SUSPENDED | G5/P5



**DE** LED-Pendelleuchte. Direkt-indirekt oder rein direktstrahlend. Leuchtenkörper in minimalistischer Bauhöhe aus Aluminiumprofil. Oberfläche natureloxiert oder weiß, graphit, schwarz bzw. champagnerfarben lackiert sowie Alu poliert. Weitere Oberflächenoptionen siehe Lightnet-Surface-Collection oder RAL nach Wahl. Microprismenoptik mit optimierter Blendungsbegrenzung speziell für Office-Anwendungen. Satinierter Opaldiffusor für Allgemeinbeleuchtung mit max. Transmissionsgrad und homogener Lichtpunktauflösung. Indirektanteil mit innovativer Linsentechnologie für breitstrahlende Deckenaufhellung. Konverter in Leuchtgehäuse integriert, wahlweise einfach schaltbar oder stufenlos dimmbar (1-10V, DALI, Touch-Dim, Casambi). Farbtemperaturen 2700K, 3000K, 3500K oder 4000K. Binning initial  $\leq$  MacAdam 3. Farbwiedergabe CRI>80 oder CRI>90. Stufenlos höhenverstellbare Y-Seil- oder Parallel-Seilabhangung mit transparent ummantelter Zuleitung.

**EN** LED pendant luminaire. Direct-indirect or Direct Only light distribution. Luminaire body with minimalist overall height made of aluminium profile. Surface natural anodised or white, graphite, black or champagne coated as well as polished aluminium. Further surface options see Lightnet-Surface-Collection or RAL of your choice. Microprismatic with optimized glare reduction especially for workplaces. Satin opal diffuser for general lighting with maximum transmittance and homogeneous lighting. Indirect light with innovative lens technology for wide-angle ceiling illumination. Converter integrated into luminaire housing, optionally switchable or dimmable (1-10V, DALI, Touch-Dim, Casambi). Colour temperature 2700K, 3000K, 3500K or 4000K. Binning initial  $\leq$  MacAdam 3. Colour rendering CRI>80 or CRI>90. Height adjustable Y-cord suspension or parallel-cord suspension with transparent power supply cable.

**FR** Luminaire LED suspendu. clairage direct/indirect ou seulement direct. Corps du luminaire en profil aluminium et paisseur minimaliste. Surface anodisee ou laquee blanc, graphite, noir, champagne ou polie. Autres options de finition voir Lightnet-Surface-Collection ou RAL au choix. Diffuseur microprismatique optimise pour un blouissement limite et adapte aux bureaux. Diffuseur opale satine pour un clairage general et une transmission maximale et homogene. Composants indirects avec une technologie de lentille innovante pour un clairage grand angle du plafond. Driver integre dans le luminaire, au choix ON/OFF ou graduable (1-10V, DALI, Touch-Dim, Casambi). Temperature de couleur 2700K, 3000K, 3500K ou 4000K. Binning initial  $\leq$  MacAdam 3. Rendu de couleur CRI>80 ou CRI>90. Filin et tendeur rapide reglable en Y ou filin parallele droit avec cable d'alimentation transparent.



**PRODUCT-CODE:** C P5 A B E - 8 30 M - L900 - Y

PRODUCT FAMILY	- C: Cubic
TYPE	- P5: Suspended Direct-Indirect G5: Suspended Direct Only
OPTICAL SYSTEM	- A: Microprismatic, O: Opal Diffuser
SURFACE FINISH	- W: Snow White, E: Silver Anodised, U: Urban Graphite, B: Jet Black, H: Champagne Silver, P: Polished Aluminium
CONTROL GEAR	- E: On/Off, L: DALI, D: 1-10V, H: Touch-Dim, C: Casambi, M: Multisensor
COLOUR REND.	- 8: CRI>80, 9: CRI>90
COLOUR TEMP.	- 27: 2700K, 30: 3000K, 35: 3500K, 40: 4000K, TW: Tunable White 2700-6500K
POWER	- M: Medium Power, H: High Power
SIZE	- Luminaire Length in mm L900, L1200, L1500
SUSPENSION	- Y: Y-Cord Suspension, K: 4-Cord Suspension
ON REQUEST	- Emergency Module, Radar Sensor, Cable colour: Red, Black



MICROPRISMATIC / DIRECT-INDIRECT

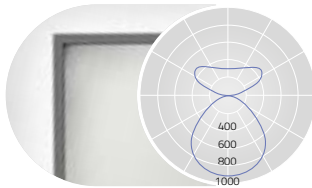

UGR $\leq$ 19 (X=4H, Y=8H, S=0.25H)  
DIRECT: ca.60% INDIRECT ca.40%

L mm	Lumen/Watt Medium Power	Lumen/Watt High Power
900	4950lm/41W	6700lm/56W
1200	6750lm/53W	9110lm/73W
1500	8540lm/65W	11580lm/90W

MICROPRISMATIC / DIRECT



UGR $\leq$ 19 for Medium Power (X=4H, Y=8H, S=0.25H)  
DIRECT: 100%

L mm	Lumen/Watt Medium Power	Lumen/Watt High Power
900	3230lm/26W	4610lm/37W
1200	4460lm/33W	6320lm/48W
1500	5680lm/41W	8090lm/59W

OPAL DIFFUSER / DIRECT-INDIRECT

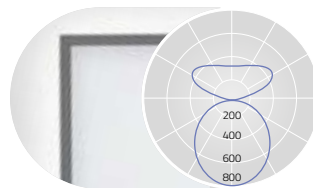

DIRECT: ca.60% INDIRECT ca.40%

L mm	Lumen/Watt Medium Power	Lumen/Watt High Power
900	4670lm/41W	6290lm/56W
1200	6650lm/53W	8980lm/73W
1500	8120lm/65W	10970lm/90W

OPAL DIFFUSER / DIRECT



DIRECT: 100%

L mm	Lumen/Watt Medium Power	Lumen/Watt High Power
900	2950lm/26W	4200lm/37W
1200	4360lm/33W	6190lm/48W
1500	5260lm/41W	7480lm/59W

Lumen Values: Luminaire luminous flux at 4000K/CRI>80. Other configurations on request.



MULTISENSOR CONTROL

EMERGENCY MODULE



SNOW WHITE

SILVER ANODISED

URBAN GRAPHITE

JET BLACK

CHAMPAGNE SILVER

POLISHED ALUMINIUM



CUBIC EVOLUTION  
SUSPENDED | G6/P6



**DE** LED-Pendelleuchte. Direkt-indirekt oder rein direktstrahlend. Leuchtenkörper in minimalistischer Bauhöhe aus Aluminiumprofil. Oberfläche naturelxiert oder weiß, graphit, schwarz bzw. champagnerfarben lackiert sowie Alu poliert. Weitere Oberflächenoptionen siehe Lightnet-Surface-Collection oder RAL nach Wahl. Microprismenoptik mit optimierter Blendungsbegrenzung speziell für Office-Anwendungen. Satinierter Opaldiffusor für Allgemeinbeleuchtung mit max. Transmissionsgrad und homogener Lichtpunktauflösung. Indirektanteil mit innovativer Linsentechnologie für breitstrahlende Deckenaufhellung. Konverter in Leuchtgehäuse integriert, wahlweise einfach schaltbar oder stufenlos dimmbar (1-10V, DALI, Touch-Dim, Casambi). Farbtemperaturen 2700K, 3000K, 3500K oder 4000K. Binning initial  $\leq$  MacAdam 3. Farbwiedergabe CRI>80 oder CRI>90. Stufenlos höhenverstellbare Parallel-Seilabhängung mit transparent ummantelter Zuleitung.

**EN** LED pendant luminaire. Direct-indirect or Direct Only light distribution. Luminaire body with minimalist overall height made of aluminium profile. Surface natural anodised or white, graphite, black or champagne coated as well as polished aluminium. Further surface options see Lightnet-Surface-Collection or RAL of your choice. Microprismatic with optimized glare reduction especially for workplaces. Satin opal diffuser for general lighting with maximum transmittance and homogeneous lighting. Indirect light with innovative lens technology for wide-angle ceiling illumination. Converter integrated into luminaire housing, optionally switchable or dimmable (1-10V, DALI, Touch-Dim, Casambi). Colour temperature 2700K, 3000K, 3500K or 4000K. Binning initial  $\leq$  MacAdam 3. Colour rendering CRI>80 or CRI>90. Height-adjustable parallel-cord suspension with transparent power supply cable.

**FR** Luminaire LED suspendu. Éclairage direct/indirect ou seulement direct. Corps du luminaire en profilé aluminium et épaisseur minimaliste. Surface anodisée ou laquée blanc, graphite, noir, champagne ou polie. Autres options de finition voir Lightnet-Surface-Collection ou RAL au choix. Diffuseur microprismatique optimisé pour un éblouissement limité et adapté aux bureaux. Diffuseur opale satiné pour un éclairage général et une transmission maximale et homogène. Composants indirects avec une technologie de lentille innovante pour un éclairage grand angle du plafond. Driver intégré dans le luminaire, au choix ON/OFF ou graduable (1-10V, DALI, Touch-Dim, Casambi). Température de couleur 2700K, 3000K, 3500K ou 4000K. Binning initial  $\leq$  MacAdam 3. Rendu de couleur CRI>80 ou CRI>90. Filin parallèle droit et tendeur rapide réglable avec câble d'alimentation transparent.

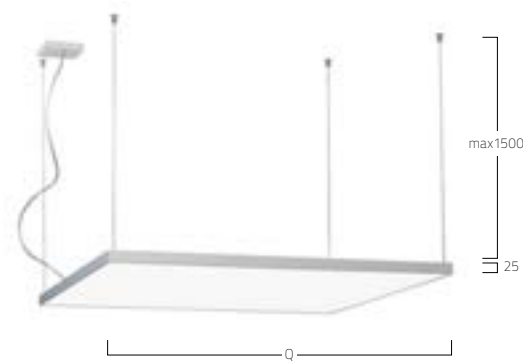

**PRODUCT-CODE: C P6 A B E - 8 30 M - Q600 - K**

- PRODUCT FAMILY – C: Cubic
- TYPE – P6: Direct-Indirect, G6: Direct Only
- OPTICAL SYSTEM – A: Microprismatic, O: Opal Diffuser
- SURFACE FINISH – W: Snow White, E: Silver Anodised, U: Urban Graphite, B: Jet Black, H: Champagne Silver, P: Polished Aluminum
- CONTROL GEAR – E: On/Off, L: DALI, D: 1-10V, H: Touch-Dim, C: Casambi, M: Multisensor
- COLOUR REND. – 8: CRI>80, 9: CRI>90
- COLOUR TEMP. – 27: 2700K, 30: 3000K, 35: 3500K, 40: 4000K, TW: Tunable White 2700-6500K
- POWER – M: Medium Power, H: High Power
- SIZE – Square size in mm: Q300, Q400, Q500, Q600, Q800
- SUSPENSION – K: Parallel Suspension
- ON REQUEST – Emergency Module, Radar Sensor, Cable colour: Red, Black



MICROPRISMATIC / DIRECT-INDIRECT

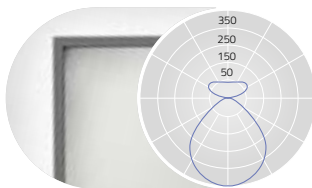

UGR $\leq$ 19 (X=4H, Y=8H, S=0.25H)  
DIRECT: ca.75% INDIRECT ca.25%

L mm	Lumen/Watt Medium Power	Lumen/Watt High Power
300	1600lm/13W	2360lm/20W
400	2590lm/19W	3570lm/27W
500	4490lm/33W	5860lm/44W
600	6670lm/46W	9240lm/66W
800	11240lm/78W	15080lm/110W

MICROPRISMATIC / DIRECT

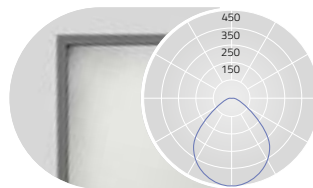

UGR $\leq$ 19 for Medium Power (X=4H, Y=8H, S=0.25H)  
DIRECT: 100%

L mm	Lumen/Watt Medium Power	Lumen/Watt High Power
300	1250lm/11W	1820lm/16W
400	2150lm/16W	2950lm/24W
500	3330lm/26W	4350lm/34W
600	4810lm/35W	6630lm/50W
800	7920lm/57W	10650lm/78W

OPAL DIFFUSER / DIRECT-INDIRECT

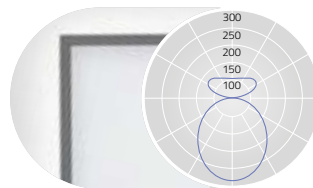

DIRECT: ca.75% INDIRECT ca.25%

L mm	Lumen/Watt Medium Power	Lumen/Watt High Power
300	1560lm/13W	2300lm/20W
400	2560lm/19W	3530lm/27W
500	4450lm/33W	5800lm/44W
600	6610lm/46W	9110lm/66W
800	11150lm/78W	14960lm/110W

OPAL DIFFUSER / DIRECT

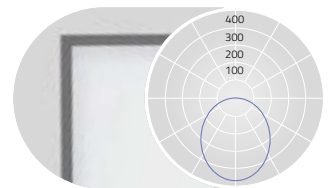

DIRECT 100%

L mm	Lumen/Watt Medium Power	Lumen/Watt High Power
300	1210lm/11W	1760lm/16W
400	2120lm/16W	2910lm/24W
500	3290lm/26W	4290lm/34W
600	4750lm/35W	6500lm/50W
800	7830lm/57W	10530lm/78W

Lumen Values: Luminaire luminous flux at 4000K/CRI>80. Other configurations on request.



MULTISENSOR CONTROL

EMERGENCY MODULE



SNOW WHITE

SILVER ANODISED

URBAN GRAPHITE

JET BLACK

CHAMPAGNE SILVER

POLISHED ALUMINIUM

CUBIC EVOLUTION CLUSTER  
SUSPENDED | G6/P6



**DE** LED Cluster-Pendelleuchte. Einzelne quadratische Module können zu verschiedenen Konfigurationen verbunden werden. Direkt-indirekt oder rein direktstrahlend. Leuchtenkörper in minimalistischer Bauhöhe aus Aluminiumprofil. Oberfläche naturelxiert oder weiß, graphit, schwarz bzw. champagnerfarben lackiert sowie Alu poliert. Weitere Oberflächenoptionen siehe Lightnet-Surface-Collection oder RAL nach Wahl. Microprismenoptik mit optimierter Blendungsbegrenzung speziell für Office-Anwendungen. Satinierter Opaldiffusor für Allgemeinbeleuchtung mit max. Transmissionsgrad und homogener Lichtpunktauflösung. Indirektanteil mit innovativer Linsentechnologie für breitstrahlende Deckenaufhellung. Konverter in Leuchtengehäuse integriert, wahlweise einfach schaltbar oder stufenlos dimmbar (1-10V, DALI, Touch-Dim, Casambi). Farbtemperaturen 2700K, 3000K, 3500K oder 4000K. Binning initial  $\leq$  MacAdam 3. Farbwiedergabe CRI>80 oder CRI>90. Stufenlos höhenverstellbare Parallel-Seilabhängung mit transparent ummantelter Zuleitung. Auf Anfrage: Integration von Notlichtkomponenten, Sensortechnologie, Zuleitungskabel in soft-touch schwarz oder rot.

**EN** LED cluster pendant luminaire. Single square modules can be combined to different configurations. Direct-indirect or Direct Only light distribution. Luminaire body with minimalistic overall height made of aluminium profile. Surface natural anodised or white, graphite, black or champagne coated as well as polished aluminium. Further surface options see Lightnet-Surface-Collection or RAL of your choice. Microprismatic with optimized glare reduction especially for workplaces. Satin opal diffuser for general lighting with maximum transmittance and homogeneous lighting. Indirect light with innovative lens technology for wide-angle ceiling illumination. Converter integrated into luminaire housing, optionally switchable or dimmable (1-10V, DALI, Touch-Dim, Casambi). Colour temperature 2700K, 3000K, 3500K or 4000K. Binning initial  $\leq$  MacAdam 3. Colour rendering CRI>80 or CRI>90. Height-adjustable parallel-cord suspension with transparent power supply cable. On request: Integration of emergency lighting components, sensor technology, soft-touch black or red sheathed supply line.

**FR** Luminaire-Cluster LED suspendu. Les modules carrés individuels peuvent être combinés entre eux afin de créer des configurations différentes. Éclairage direct/indirect ou seulement direct. Corps du luminaire en profilé aluminium et épaisseur minimaliste. Surface anodisée ou laquée blanc, graphite, noir, champagne ou polie. Autres options de finition voir Lightnet-Surface-Collection ou RAL au choix. Diffuseur microprismatique optimisé pour un éblouissement limité et adapté aux bureaux. Diffuseur opale satiné pour un éclairage général et une transmission maximale et homogène. Composants indirects avec une technologie de lentille innovante pour un éclairage grand angle du plafond. Driver intégré dans le luminaire, au choix ON/OFF ou graduable (1-10V, DALI, Touch-Dim, Casambi). Température de couleur 2700K, 3000K, 3500K ou 4000K. Binning initial  $\leq$  MacAdam 3. Rendu de couleur CRI>80 ou CRI>90. Filin parallèle droit et tendeur rapide réglable avec câble d'alimentation transparent. Sur demande: Intégration de batterie de secours, technologie de sensor/cellule, câble d'alimentation matière-tissu soft-touch noir ou rouge.

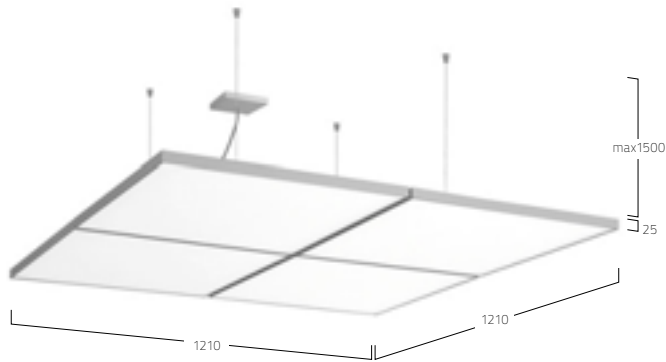

**PRODUCT-CODE: C P6 A B E - 8 30 M - C2X2 - K**

PRODUCT FAMILY	- C: Cubic
TYPE	- P6: Suspended Direct-Indirect G6: Suspended Direct Only
OPTICAL SYSTEM	- A: Microprismatic, O: Opal Diffuser
SURFACE FINISH	- W: Snow White, E: Silver Anodised, U: Urban Graphite, B: Jet Black, H: Champagne Silver, P: Polished Aluminum
CONTROL GEAR	- E: On/Off, L: DALI, D: 1-10V, H: Touch-Dim, C: Casambi
COLOUR REND.	- 8: CRI>80, 9: CRI>90
COLOUR TEMP.	- 27: 2700K, 30: 3000K, 35: 3500K, 40: 4000K, TW: Tunable White 2700-6500K
POWER	- E: Low Power, M: Medium Power
SIZE	- C: C2X2, C1X3, C2X3, C3X3
SUSPENSION	- K: Parallel Suspension
ON REQUEST	- Emergency Module, Multisensor, Radar Sensor, Cable colour: Red, Black

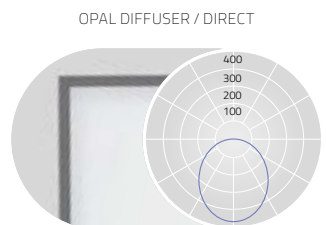
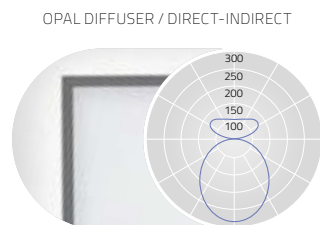
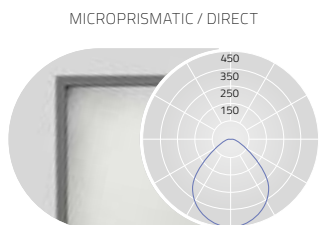
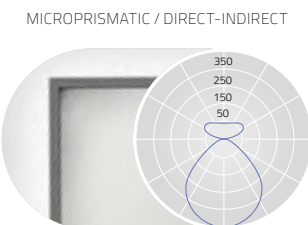
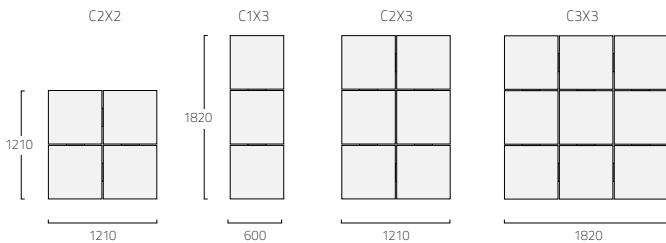

UGR $\leq$ 19 (X=4H, Y=8H, S=0.25H)  
DIRECT: ca.60% INDIRECT ca.40%

C	Lumen/Watt Low Power	Lumen/Watt Medium Power
C1X3	14550lm/98W	20010lm/138W
C2X2	19400lm/131W	26680lm/184W
C2X3	29100lm/197W	40020lm/276W
C3X3	43650lm/296W	60030lm/414W

UGR $\leq$ 19 for Medium Power (X=4H, Y=8H, S=0.25H)  
DIRECT: 100%

C	Lumen/Watt Low Power	Lumen/Watt Medium Power
C1X3	10530lm/74W	14430lm/105W
C2X2	14040lm/98W	19240lm/140W
C2X3	21060lm/148W	28860lm/210W
C3X3	31590lm/221W	43290lm/315W

DIRECT: ca.70% INDIRECT ca.30%

C	Lumen/Watt Low Power	Lumen/Watt Medium Power
C1X3	14220lm/98W	19830lm/138W
C2X2	18960lm/131W	26440lm/184W
C2X3	28440lm/197W	39660lm/276W
C3X3	42660lm/296W	59490lm/414W

DIRECT 100%

C	Lumen/Watt Low Power	Lumen/Watt Medium Power
C1X3	10200lm/74W	14250lm/105W
C2X2	13600lm/98W	19000lm/140W
C2X3	20400lm/148W	28500lm/210W
C3X3	30600lm/221W	42750lm/315W

Lumen Values: Luminaire luminous flux at 4000K/CRI>80. Other configurations on request.



CUBIC MAX  
SUSPENDED | G2/P2



**DE** LED-Pendelleuchte. Direkt-indirekt oder rein direktstrahlend. Leuchtenkörper aus Aluminiumprofil. Oberfläche naturelxiert oder weiß, graphit, schwarz bzw. champagnerfarben lackiert sowie Alu poliert. Weitere Oberflächenoptionen siehe Lightnet-Surface-Collection oder RAL nach Wahl. Microprismenoptik mit optimierter Blendungsbegrenzung speziell für Office-Anwendungen. Opaldiffusor aus satiniertem Acrylglas, ab Q1500 mit opaler Stretchfolie für Allgemeinbeleuchtung. Konverter in Leuchtgehäuse integriert, wahlweise einfach schaltbar oder stufenlos dimmbar (1-10V, DALI, Touch-Dim, Casambi). Farbtemperaturen 2700K, 3000K, 3500K oder 4000K. Binning initial  $\leq$  MacAdam 3. Farbwiedergabe CRI>80 oder CRI>90. Stufenlos höhenverstellbare Parallel-Seilabhängung mit transparent ummantelter Zuleitung. Auf Anfrage: Integration von Notlichtkomponenten (nur Q430, Q530, Q630), Sensortechnologie, Zuleitungskabel in soft-touch schwarz oder rot.

**EN** LED pendant luminaire. Direct-indirect or Direct Only light distribution. Luminaire body made of aluminium profile. Surface natural anodised or white, graphite, black or champagne coated as well as polished aluminium. Further surface options see Lightnet-Surface-Collection or RAL of your choice. Microprismatic with optimized glare reduction especially for workplaces. Opal diffuser made of acrylic glass. Q1500 and bigger with opal stretch diffuser. Driver integrated into luminaire housing, optionally switchable or dimmable (1-10V, DALI, Touch-Dim, Casambi). Colour temperature 2700K, 3000K, 3500K or 4000K. Binning initial  $\leq$  MacAdam 3. Colour rendering CRI>80 or CRI>90. Height-adjustable parallel-cord suspension with transparent power supply cable. On request: Integration of emergency lighting components (only Q430, Q530, Q630), sensor technology, soft-touch black or red sheathed power supply cable.

**FR** Luminaire LED suspendu. Éclairage direct/indirect ou seulement direct. Corps du luminaire en profilé aluminium. Surface anodisée ou laquée blanc, graphite, noir, champagne ou polie. Autres options de finition voir Lightnet-Surface-Collection ou RAL au choix. Diffuseur microprismatique optimisé pour un éblouissement limité et adapté aux bureaux. Diffuseur OPAL en verre acrylique satiné (à partir de Q1500mm en film/toile tendu opalisé) pour diverses applications d'éclairage. Driver intégré dans le luminaire, au choix ON/OFF ou graduable (1-10V, DALI, Touch-Dim, Casambi). Température de couleur 2700K, 3000K, 3500K ou 4000K. Binning initial  $\leq$  MacAdam 3. Rendu de couleur CRI>80 ou CRI>90. Filin parallèle droit et tendeur rapide réglable avec câble d'alimentation transparent. Sur demande: Intégration de batterie de secours (seulement Q430, Q530, Q630), technologie de sensor/cellule, câble d'alimentation matière-tissu soft-touch noir ou rouge.



**PRODUCT-CODE:** CP2ABE-830M-Q330-K

PRODUCT FAMILY	- C: Cubic
TYPE	- P2: Suspended Direct-Indirect G2: Suspended Direct Only
OPTICAL SYSTEM	- A: Microprismatic [max Q1200], O: Opal, [max Q1200], T: Opal stretch diffuser [Q1500, Q2000]
SURFACE FINISH	- W: Snow White, E: Silver Anodised, U: Urban Graphite, B: Jet Black, H: Champagne Silver, P: Polished Aluminium
CONTROL GEAR	- E: On/Off, L: DALI, D: 1-10V, H: Touch-Dim, C: Casambi
COLOUR REND.	- 8: CRI>80, 9: CRI>90, F: Full Spectrum
COLOUR TEMP.	- 27: 2700K, 30: 3000K, 35: 3500K, 40: 4000K, TW: Tunable White 2700-6500K [Q330-Q1200]
POWER	- M: Medium Power, H: High Power
SIZE	- Square Size in mm: Q330 Q430 Q530 Q630, Q900 Q1200 Q1500 Q2000
SUSPENSION	- K: Parallel Suspension
ON REQUEST	- Multisensor, Radar Sensor, Emergency Module, Cable colour: Red, Black



MICROPRISMATIC / DIRECT-INDIRECT

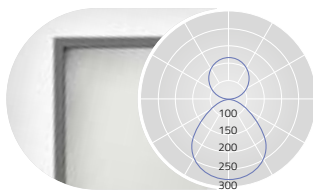

UGR<sub>s</sub>19 (X=4H, Y=8H, S=0.25H)  
DIRECT: ca.60% INDIRECT ca.40%

Q mm	Lumen/Watt Medium Power	Lumen/Watt High Power
330	2470lm/19W	3640lm/28W
430	4360lm/31W	6300lm/45W
530	6000lm/40W	11170lm/80W
630	9610lm/68W	14270lm/103W
900	11790lm/96W	19040lm/173W
1200	19520lm/161W	31640lm/288W

MICROPRISMATIC / DIRECT

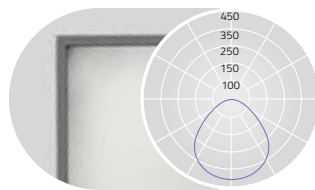

UGR<sub>s</sub>19 for Medium Power (X=4H, Y=8H, S=0.25H)  
DIRECT: 100%

Q mm	Lumen/Watt Medium Power	Lumen/Watt High Power
330	1360lm/12W	2010lm/18W
430	2370lm/20W	3450lm/29W
530	3630lm/27W	6790lm/51W
630	5200lm/40W	8500lm/65W
900	7910lm/67W	13240lm/129W
1200	14100lm/122W	23550lm/228W

OPAL DIFFUSER/FOIL / DIRECT-INDIRECT

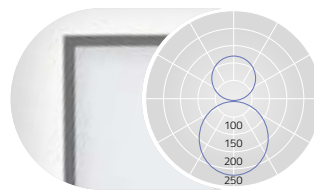

DIRECT: ca.60% INDIRECT ca.40%

Q mm	Lumen/Watt Medium Power	Lumen/Watt High Power
330	2510lm/19W	3700lm/28W
430	4430lm/31W	6400lm/45W
530	6110lm/40W	11370lm/80W
630	9770lm/68W	14530lm/103W
900	12030lm/96W	19440lm/173W
1200	19940lm/161W	32350lm/288W
1500	28130lm/238W	45370lm/433W
2000	40530lm/338W	65340lm/623W

OPAL DIFFUSER/FOIL / DIRECT

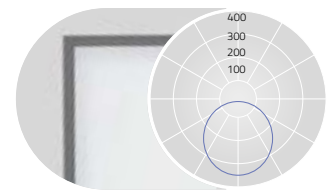

DIRECT: 100%

Q mm	Lumen/Watt Medium Power	Lumen/Watt High Power
330	1400lm/12W	2070lm/18W
430	2440lm/20W	3550lm/29W
530	3740lm/27W	6990lm/51W
630	5360lm/40W	8760lm/65W
900	8150lm/67W	13640lm/129W
1200	14520lm/122W	24260lm/228W
1500	21170lm/189W	34990lm/356W
2000	30490lm/268W	50380lm/510W

Lumen Values: Luminaire luminous flux at 4000K/CRI>80. Other configurations on request.



CUBIC AMBIENT  
SUSPENDED | G7/P7



**DE** LED-Pendelleuchte. Direkt-rundumstrahlend. Leuchtenkörper aus Aluminium. Oberfläche nature-oxidiert oder weiß, graphit, schwarz bzw. champagnerfarben lackiert. Weitere Oberflächenoptionen siehe Lightnet-Surface-Collection oder RAL nach Wahl. Ambientdiffusor aus satiniertem Acrylglas für Allgemeinbeleuchtung. Konverter in Leuchtengehäuse integriert, wahlweise einfach schaltbar oder stufenlos dimmbar (1-10V, DALI, Touch-Dim, Casambi). Farbtemperaturen 2700K, 3000K, 3500K oder 4000K. Binning initial  $\leq$  MacAdam 3. Farbwiedergabe CRI>80 oder CRI>90. Stufenlos höhenverstellbare Parallel-Seilabhängung mit transparent ummantelter Zuleitung. Auf Anfrage: Integration von Notlichtkomponenten, Sensortechnologie, Zuleitungskabel in soft-touch schwarz oder rot.

**EN** LED pendant luminaire. Omnidirectional light distribution. Luminaire body made of aluminium. Surface natural anodised or white, graphite, black or champagne coated. Further surface options see Lightnet-Surface-Collection or RAL of your choice. Ambient diffuser made of frosted acrylic glass for general lighting. Driver integrated into luminaire housing, optionally switchable or dimmable (1-10V, DALI, Touch-Dim, Casambi). Colour temperature 2700K, 3000K, 3500K or 4000K. Binning initial  $\leq$  MacAdam 3. Colour rendering CRI>80 or CRI>90. Height-adjustable parallel-cord suspension with transparent power supply cable. On request: Integration of emergency lighting components, sensor technology, soft-touch black or red sheathed power supply cable.

**FR** Luminaire LED suspendu. Diffusion de l'éclairage omnidirectionnelle. Corps du luminaire en aluminium. Surface anodisée ou laquée blanc, graphite, noir ou champagne. Autres options de finition voir Lightnet-Surface-Collection ou RAL au choix. Diffuseur AMBIENT en verre satiné acrylique pour diverses applications d'éclairage. Driver intégré dans le luminaire, au choix ON/OFF ou graduable (1-10V, DALI, Touch-Dim, Casambi). Température de couleur 2700K, 3000K, 3500K ou 4000K. Binning initial  $\leq$  MacAdam 3. Rendu de couleur CRI>80 ou CRI>90. Filin parallèle droit et tendeur rapide réglable avec câble d'alimentation transparent. Sur demande: Intégration de batterie de secours, technologie de sensor/cellule, câble d'alimentation matière-tissu soft-touch noir ou rouge.

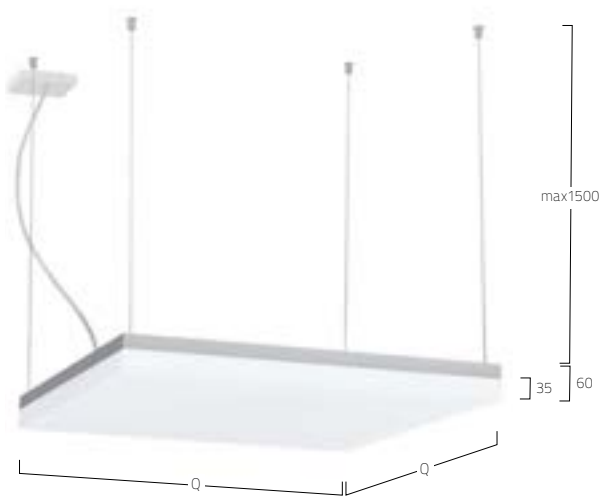

**PRODUCT-CODE:** C P7 F B E - 8 30 M - Q300 - K

PRODUCT FAMILY	- C: Cubic
TYPE	- G7: Direct Only P7: Direct-Indirect
OPTICAL SYSTEM	- F: Ambient
SURFACE FINISH	- W: Snow White, S: Radiant Silver, U: Urban Graphite, B: Jet Black, H: Champagne Silver
CONTROL GEAR	- E: On/Off, L: DALI, D: 1-10V, H: Touch-Dim, C: Casambi
COLOUR REND.	- 8: CRI>80, 9: CRI>90, F: Full Spectrum
COLOUR TEMP.	- 27: 2700K, 30: 3000K, 35: 3500K, 40: 4000K
POWER	- M: Medium Power, H: High Power
SIZE	- Square Size in mm: Q300, Q400, Q500, Q600
SUSPENSION	- K: Parallel Suspension
ON REQUEST	- Emergency Module, Radar Sensor, Cable colour: Red, Black



AMBIENT DIFFUSER / DIRECT-INDIRECT

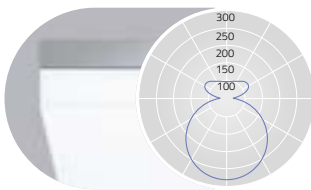

DIRECT: ca.75% INDIRECT: ca.25%

AMBIENT DIFFUSER / DIRECT



DIRECT: ca.98% INDIRECT: ca.2%

Q mm	Lumen/Watt Medium Power	Lumen/Watt High Power
300	2080lm/17W	3080lm/26W
400	3360lm/26W	4900lm/38W
500	4790lm/33W	8970lm/67W
600	8020lm/59W	11940lm/89W

Q mm	Lumen/Watt Medium Power	Lumen/Watt High Power
300	1460lm/12W	2150lm/18W
400	2510lm/20W	3660lm/29W
500	3810lm/27W	7130lm/51W
600	5410lm/40W	8850lm/65W

Lumen Values: Luminaire luminous flux at 4000K/CRI>80. Other configurations on request.

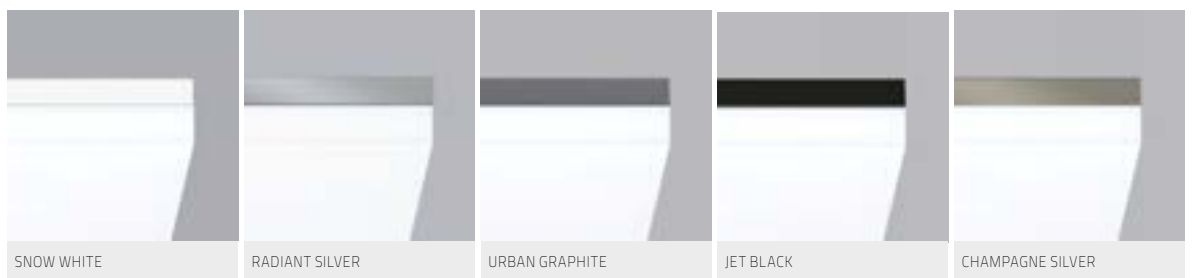



MATRIC 38 MM SQUARE  
SUSPENDED | G1/R1



**DE** LED-Pendelleuchte. Direkt-indirekt oder rein direktstrahlend. Lichtkanal aus Aluminiumprofil mit 38mm Lichtspur-Breite. Oberfläche silber, weiß, graphit, schwarz, champagner oder kupferfarben lackiert. Weitere Oberflächenoptionen siehe Lightnet-Surface-Collection oder RAL nach Wahl. Microprismenoptik mit optimierter Blendungsbegrenzung speziell für Office-Anwendungen. Satinierter Opaldiffusor für Allgemeinbeleuchtung. Konverter in Leuchtgehäuse integriert, wahlweise einfach schaltbar oder stufenlos dimmbar (1-10V, DALI, Touch-Dim, Casambi). Farbtemperaturen 2200K, 2700K, 3000K, 3500K, 4000K oder 6500K. Binning initial  $\leq$  MacAdam 3. Farbwiedergabe CRI>80 oder CRI>90. Lieferung erfolgt als fertig montierbare Einheit mit laser-verschweißten Ecken und durchgehend homogener Auflösung der Lichtpunkte. Stufenlos höhenverstellbare Parallelseilabhängung mit transparent ummantelter Zuleitung.

**EN** LED pendant luminaire with integrated acoustic element. Direct-Indirect or Direct only light distribution. Light channel made of aluminium profile with 38mm track width. Surface natural anodised or white, graphite, black, champagne or copper coated. Further surface options see Lightnet-Surface-Collection or RAL of your choice. Microprismatic with optimized glare reduction especially for workplaces. Satin opal diffuser for general lighting. Converter integrated into luminaire housing, optionally switchable or dimmable (1-10V, DALI, Touch-Dim, Casambi). Colour temperatures 2200K, 2700K, 3000K, 3500K, 4000K or 6500K. Binning initial  $\leq$  MacAdam 3. Colour rendering CRI>80 or CRI>90. Height-adjustable cord suspension with transparent power supply cable.

**FR** Luminaire LED suspendu. Éclairage direct/indirect ou seulement direct. Rail lumineux en profilé d'aluminium avec une largeur d'éclairage de 38 mm. Surface laquée argent, blanc, graphite, noir, champagne ou cuivre. Autres options de finition voir Lightnet-Surface-Collection ou RAL au choix. Diffuseur microprismatique optimisé pour un éblouissement limité et adapté aux bureaux. Diffuseur opale satinée pour un éclairage général. Driver intégré dans le luminaire, au choix ON/OFF ou graduable (1-10V, DALI, Touch-Dim, Casambi). Température de couleur 2200K, 2700K, 3000K, 3500K, 4000K ou 6500K. Binning initial  $\leq$  MacAdam 3. Rendu de couleur CRI>80 ou CRI>90. Livraison sous forme d'unité prête au montage avec angles soudés au laser et distribution homogène et continue des points lumineux. Filin parallèle droit et tendeur rapide réglable avec câble d'alimentation transparent.

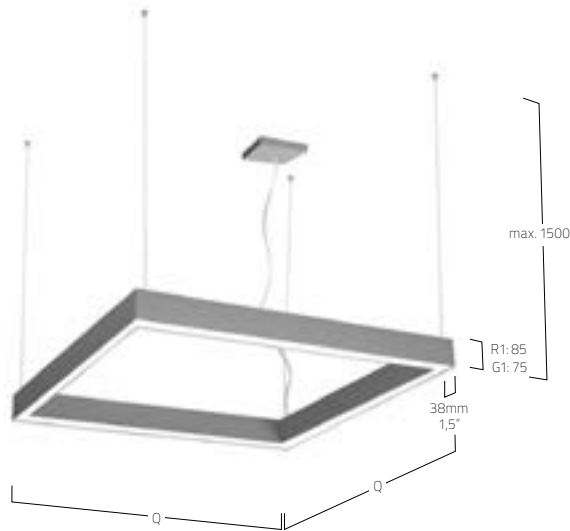

**PRODUCT-CODE:** L G 1 A S E - 8 30 M - Q920 - K

PRODUCT FAMILY	- L: Matric
TYPE	- G1: Direct, R1: Direct-Indirect
OPTICAL SYSTEM	- O: Opal, A: Microprismatic
SURFACE FINISH	- W: Snow White, S: Radiant Silver, U: Urban Graphite, B: Jet Black, H: Champagne Silver, K: Satin Copper
CONTROL GEAR	- E: On/Off, L: DALI, D: 1-10V, H: Touch-Dim, A: Casambi Micro
COLOUR REND.	- 8: CRI>80, 9: CRI>90, F: Full Spectrum
COLOUR TEMP.	- 22: 2200K, 27: 2700K, 30: 3000K, 35: 3500K, 40: 4000K, 65: 6500K, TW: Tunable White 2700-6500K
POWER	- M: Medium Power, H: High Power
SIZE	- Luminaire length in mm: Q630, Q920, Q1210, Q1500
SUSPENSION	- K: Parallel Suspension
ON REQUEST	- Magnetic Track, 3-Phase Track, Midpin Spotlights, Lens Louver-Inset, Emergency Module, Multisensor, Cable colour Red or Black



MICROPRISMATIC / DIRECT-INDIRECT

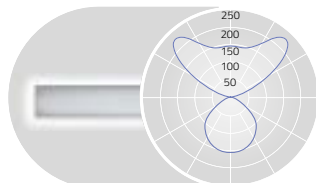

UGR $\leq$ 19 for Medium Power (X=4H, Y=8H, S=0.25H)  
DIRECT: ca. 45% INDIRECT ca. 55%

L mm	Lumen/Watt Medium Power	Lumen/Watt High Power
630	7190lm/54W	9730lm/74W
920	11170lm/81W	15110lm/112W
1210	15150lm/107W	20490lm/149W
1500	19130lm/134W	25870lm/189W

OPAL / DIRECT-INDIRECT

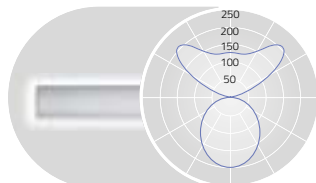

DIRECT: ca. 45% INDIRECT ca. 55%

L mm	Lumen/Watt Medium Power	Lumen/Watt High Power
630	3350lm/29W	4540lm/40W
920	5030lm/43W	6800lm/59W
1210	6710lm/56W	9070lm/78W
1500	8390lm/69W	11340lm/99W

MICROPRISMATIC / DIRECT ONLY

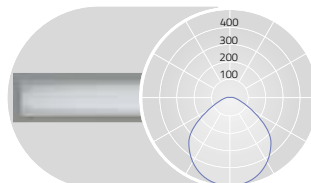

DIRECT 100%

L mm	Lumen/Watt Medium Power	Lumen/Watt High Power
630	7450lm/54W	10070lm/74W
920	11560lm/81W	15620lm/112W
1210	15660lm/107W	21180lm/149W
1500	19770lm/134W	26730lm/189W

OPAL / DIRECT ONLY

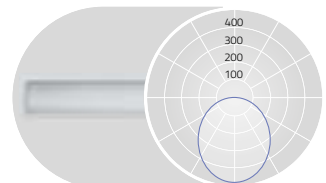

DIRECT 100%

L mm	Lumen/Watt Medium Power	Lumen/Watt High Power
630	3610lm/29W	4880lm/40W
920	5420lm/43W	7320lm/59W
1210	7220lm/56W	9760lm/78W
1500	9020lm/69W	12200lm/99W

Lumen Values: Luminaire luminous flux at 4000K/CRI>80. Other configurations on request.



# MATRIC 38<sub>MM</sub> SQUARE ACOUSTIC SUSPENDED | G1/R1

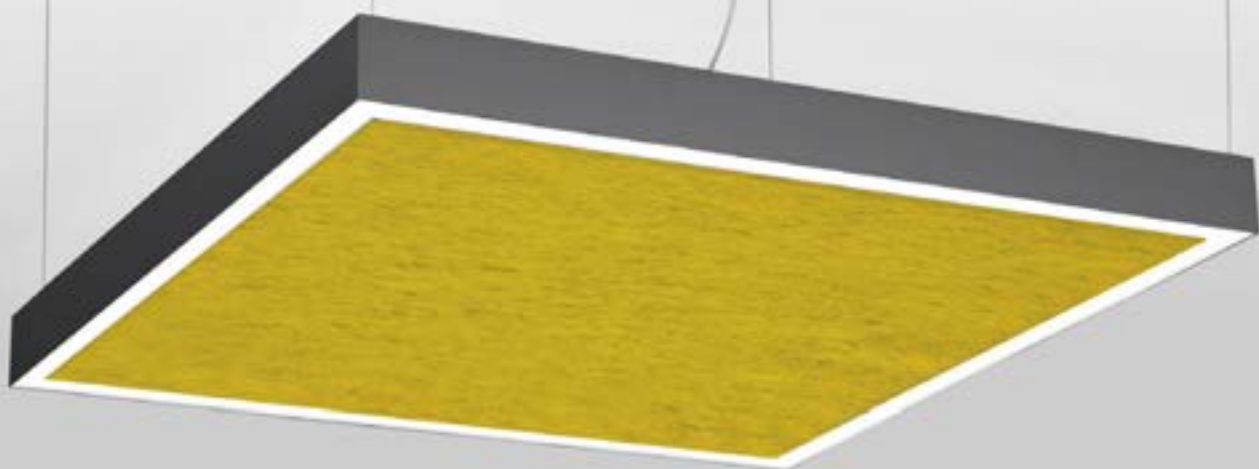

## ACOUSTIC ABSORBERS

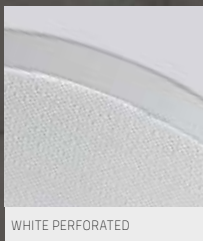

WHITE PERFORATED

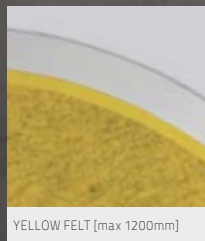

YELLOW FELT [max 1200mm]



GRAPHIT FELT [max 1200mm]

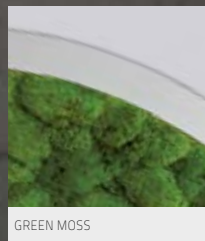

GREEN MOSS

**DE** LED-Pendelleuchte mit integriertem Akustikelement. Direkt-indirekt oder rein direktstrahlend. Lichtkanal aus Aluminiumprofil mit 38mm Lichtspur-Breite. Oberfläche silber, weiß, graphit, schwarz, champagner oder kupferfarben lackiert. Weitere Oberflächenoptionen siehe Lightnet-Surface-Collection oder RAL nach Wahl. Akustisch hochwirksamer Breitbandabsorber integriert, wahlweise einfach schaltbar oder stufenlos dimmbar (1-10V, DALI, Touch-Dim, Casambi). Farbtemperaturen 2200K, 2700K, 3000K, 3500K, 4000K oder 6500K. Binning initial  $\leq$  MacAdam 3. Farbwiedergabe CRI>80 oder CRI>90. Supplied as a ready-to-mount unit with laser-welded corners and uniform and enhanced light transmission.

**EN** LED pendant luminaire with integrated acoustic element. Direct-indirect or direct-only light distribution. Light channel made of aluminium profile with 38mm profile width. Surface silver, white, graphite, black, champagne or copper coated. Further surface options see Lightnet-Surface-Collection or RAL of your choice. Acoustically highly effective broadband absorber selectable from 4 variants (Green Moss, Yellow Felt, Graphite Felt or White Perforated). Microprismatic with optimized glare reduction especially for workplaces. Satin opal diffuser for general lighting. Driver integrated into luminaire housing, optionally switchable or dimmable (1-10V, DALI, Touch-Dim, Casambi). Colour temperatures 2200K, 2700K, 3000K, 3500K, 4000K or 6500K. Binning initial  $\leq$  MacAdam 3. Colour rendering CRI>80 or CRI>90. Supplied as a ready-to-mount unit with laser-welded corners and uniform and enhanced light transmission.

**FR** Luminaire suspendu à LED avec élément acoustique intégré. Éclairage direct/indirect ou seulement direct. Rail lumineux en profilé d'aluminium avec une largeur d'éclairage de 38 mm. Surface laquée argent, blanc, graphite, noir, champagne ou cuivre. Autres options de finition voir Lightnet-Surface-Collection ou RAL au choix. Absorbent acoustique à bande large et haute efficacité disponible au choix avec 4 modèles (Mousse verte, feutre jaune, feutre graphite ou blanc perforé). Diffuseur microprismatique optimisé pour un éblouissement limité et adapté aux bureaux. Diffuseur opale satinée pour un éclairage général. Driver intégré dans le luminaire, au choix ON/OFF ou graduable (1-10V, DALI, Touch-Dim, Casambi). Température de couleur 2200K, 2700K, 3000K, 3500K, 4000K ou 6500K. Binning initial  $\leq$  Mac Adam 3. Rendu de couleur CRI>80 ou CRI>90. Livraison sous forme d'unité prête au montage avec angles soudés au laser et distribution homogène et continue des points lumineux.

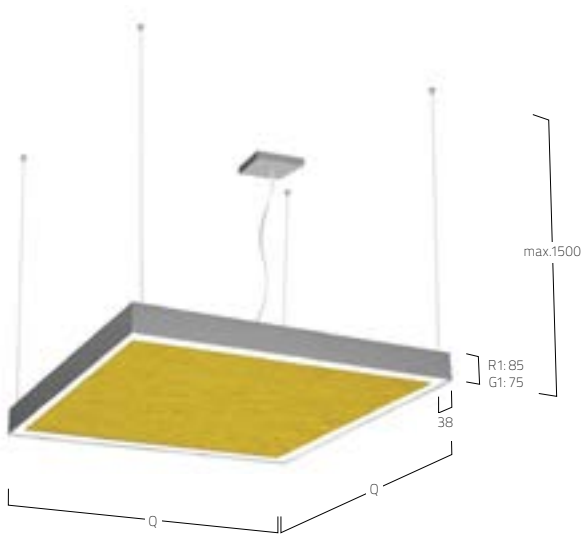

**PRODUCT-CODE:** L G 1 A S E - 8 30 M - Q920 - K - AY

PRODUCT FAMILY	L: Matrix
TYPE	G1: Direct, R1: Direct-Indirect
OPTICAL SYSTEM	O: Opal, A: Microprismatic
SURFACE FINISH	W: Snow White, S: Radiant Silver, U: Urban Graphite, H: Champagne Silver, K: Satin Copper
CONTROL GEAR	E: On/Off, L: DALI, D: 1-10V, H: Touch-Dim, A: Casambi Micro
COLOUR REND.	8: CRI>80, 9: CRI>90, F: Full Spectrum
COLOUR TEMP.	22: 2200K, 27: 2700K, 30: 3000K, 35: 3500K, 40: 4000K, 65: 6500K, TW: Tunable White 2700-6500K
POWER	M: Medium Power, H: High Power
SIZE	Luminaire length in mm: Q630, Q920, Q1210, Q1500
SUSPENSION	K: Parallel Suspension
ACOUSTIC ABSORB	AY: Yellow Felt [max Q1210], AG: Graphite Felt [max Q1210], AM: Green Moss, AW: White Perforated
ON REQUEST	Magnetic Track, 3-Phase Track, Midpin Spotlights, Lens Louver-Inset, Emergency Module, Multisensor, Cable colour Red or Black

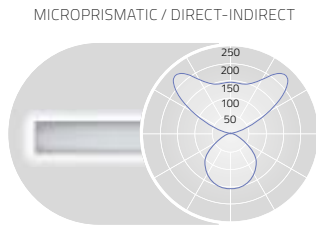

UGR $\leq$ 19 for Medium Power (X=4H, Y=8H, S=0.25H)  
DIRECT: ca. 45% INDIRECT ca. 55%

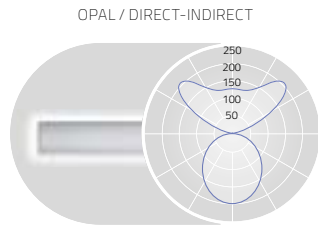

DIRECT: ca. 45% INDIRECT ca. 55%

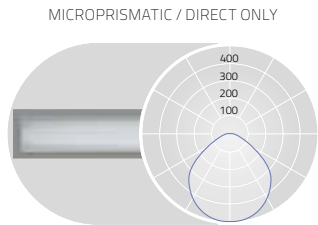

DIRECT 100%

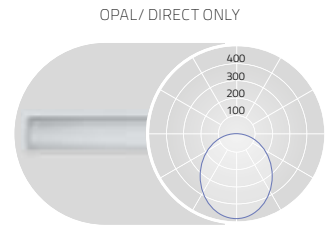

DIRECT 100%

L mm	Lumen/Watt Medium Power	Lumen/Watt High Power
630	7190lm/54W	9730lm/74W
920	11170lm/81W	15110lm/112W
1210	15150lm/107W	20490lm/149W
1500	19130lm/134W	25870lm/189W

L mm	Lumen/Watt Medium Power	Lumen/Watt High Power
630	3350lm/29W	4540lm/40W
920	5030lm/43W	6800lm/59W
1210	6710lm/56W	9070lm/78W
1500	8390lm/69W	11340lm/99W

L mm	Lumen/Watt Medium Power	Lumen/Watt High Power
630	7450lm/54W	10070lm/74W
920	11560lm/81W	15620lm/112W
1210	15660lm/107W	21180lm/149W
1500	19770lm/134W	26730lm/189W

L mm	Lumen/Watt Medium Power	Lumen/Watt High Power
630	3610lm/29W	4880lm/40W
920	5420lm/43W	7320lm/59W
1210	7220lm/56W	9760lm/78W
1500	9020lm/69W	12200lm/99W

Lumen Values: Luminaire luminous flux at 4000K/CRI>80. Other configurations on request.



MATRIC 38<sub>MM</sub> BAFFLE  
SUSPENDED | G1



**DE** LED-Pendelleuchte mit integriertem Akustikelement. Rein direktstrahlend. Lichtkanal aus Aluminiumprofil mit 38mm Lichtspur-Breite. Oberfläche nature-oxidiert oder weiß, graphit, schwarz, champagner oder kupferfarben lackiert. Weitere Oberflächenoptionen siehe Lightnet-Surface-Collection oder RAL nach Wahl. Microprismenoptik mit optimierter Blendungsbegrenzung speziell für Office-Anwendungen. Satinierter Opaldiffusor für Allgemeinbeleuchtung. Konverter in Leuchtgehäuse integriert, wahlweise einfach schaltbar oder stufenlos dimmbar (1-10V, DALI, Touch-Dim, Casambi). Colour temperatures 2200K, 2700K, 3000K, 3500K, 4000K oder 6500K. Binning initial  $\leq$  MacAdam 3. Colour rendering CRI>80 oder CRI>90. Stufenlos höhenverstellbare Seilabhängung mit transparent ummantelter Zuleitung.

**EN** LED pendant luminaire with integrated acoustic element. Direct only light distribution. Light channel made of aluminium profile with 38mm track width. Surface natural anodised or white, graphite, black, champagne or copper coated. Further surface options see Lightnet-Surface-Collection or RAL of your choice. Microprismatic with optimized glare reduction especially for workplaces. Satin opal diffuser for general lighting. Converter integrated into luminaire housing, optionally switchable or dimmable (1-10V, DALI, Touch-Dim, Casambi). Colour temperatures 2200K, 2700K, 3000K, 3500K, 4000K or 6500K. Binning initial  $\leq$  MacAdam 3. Colour rendering CRI>80 or CRI>90. Height-adjustable cord suspension with transparent power supply cable.

**FR** Luminaire suspendu à LED avec élément acoustique intégré. Éclairage seulement direct. Rail lumineux en profilé d'aluminium avec une largeur d'éclairage de 38 mm. Surface anodisée ou laquée blanc, graphite, noir, champagne ou cuivre. Autres options de finition voir Lightnet-Surface-Collection ou RAL au choix. Diffuseur microprismatique optimisé pour un éblouissement limité et adapté aux bureaux. Diffuseur opale satinée pour un éclairage général. Driver intégré dans le luminaire, au choix ON/OFF ou graduable (1-10V, DALI, Touch-Dim, Casambi). Température de couleur 2200K, 2700K, 3000K, 3500K, 4000K ou 6500K. Binning initial  $\leq$  MacAdam 3. Rendu de couleur CRI>80 ou CRI>90. Suspension réglable en hauteur avec câble d'alimentation transparent.

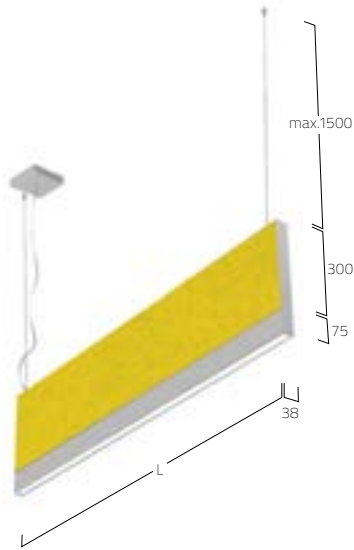

**PRODUCT-CODE: L G 1 A S E - 8 30 M - L1182 - A - AY**

PRODUCT FAMILY	- L: Matric
TYPE	- G1: Suspended Direct Only
OPTICAL SYSTEM	- H: Microprismatic Plus, A: Microprismatic, O: Opal
SURFACE FINISH	- W: Snow White, S: Radiant Silver, B: Jet Black, U: Urban Graphite, H: Champagne Silver, K: Satin Copper
CONTROL GEAR	- E: On/Off, L: DALI, D: 1-10V, H: Touch-Dim, A: Casambi Micro
COLOUR REND.	- 8: CRI>80, 9: CRI>90, F: Full Spectrum
COLOUR TEMP.	- 22: 2200K, 27: 2700K, 30: 3000K, 35: 3500K, 40: 4000K, 65: 6500K, TW: Tunable White 2700-6500K
POWER	- M: Medium Power, H: High Power
SIZE	- Luminaire length in mm: L1182, L1475
SUSPENSION	- A: Single Cord Suspension
ACOUSTIC ABSORB	- AY: Yellow Felt, AG: Graphite Felt
ON REQUEST	- Magnetic Track, 3-Phase Track, Midpin Spotlights, Lens Louver-Inset, Emergency Module, Multisensor

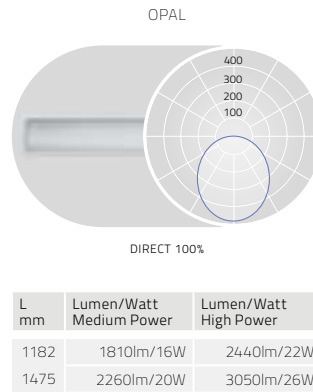
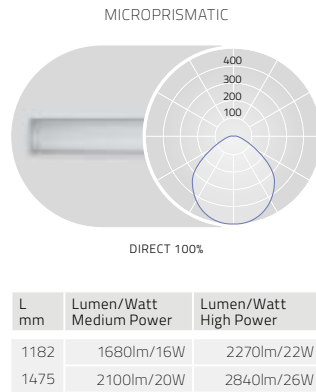
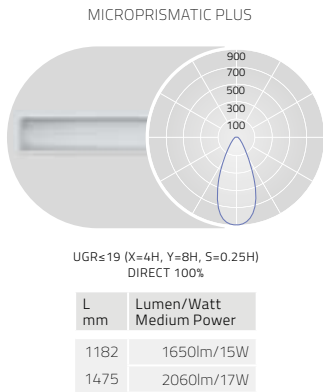

Lumen Values: Luminaire luminous flux at 4000K/CRI>80. Other configurations on request.



# MATRIC 38<sub>MM</sub> LENS LOUVER SUSPENDED | P2



**DE** LED-Pendelleuchte. Direkt-indirektstrahlend oder rein direktstrahlend. Lichtkanal aus Aluminiumprofil mit 38mm Lichtspur-Breite. Millimetergenaue Längenfertigung nach Vorgabe möglich. Oberfläche weiß, silber, graphit, schwarz, champagner oder kupferfarben lackiert. Weitere Oberflächenoptionen siehe Lightnet-Surface-Collection oder RAL nach Wahl. Direktanteil über Präzisionslinsen mit Abblenderaster für breite rotationssymmetrische Lichtstärkeverteilung bei gleichzeitig hoher Blendungsbegrenzung (UGR<16). Raster in verschiedenen Farbausführungen erhältlich. Indirektanteil mit innovativer Linsentechnologie für breitstrahlende Deckenaufhellung. Konverter in Leuchtengehäuse integriert, wahlweise einfach schaltbar oder stufenlos dimmbar (DALI). Farbtemperaturen 2700K, 3000K oder 4000K. Binning initial  $\leq$  MacAdam 3. Farbwiedergabe CRI>80. Pendelhöhe nach Vorgabe (min. 450mm).

**EN** LED pendant luminaire. Direct-indirect or Direct Only light distribution. Light channel made of aluminium profile with 38mm track width. Precise length production according to specifications possible. Surface white, silver, graphite, black, champagne or copper coated. Further surface options see Lightnet-Surface-Collection or RAL of your choice. Direct part using precision lenses with louvre for wide rotationally symmetrical light distribution with high glare limitation (UGR<16). Louvre available in various colour combinations. Indirect light with innovative lens technology for wide-angle ceiling illumination. Converter integrated into luminaire housing, optionally switchable or dimmable (DALI). Colour temperature 2700K, 3000K or 4000K. Binning initial  $\leq$  MacAdam 3. Colour rendering CRI>80. Suspending height according to specification (min. 450mm).

**FR** Luminaire LED suspendu. Éclairage direct/indirect ou seulement direct. Rail lumineux en profilé d'aluminium avec une largeur d'éclairage de 38 mm. Fabrication au millimètre près des longueurs selon les spécifications. Surface laquée blanc, argent, graphite, noir, champagne ou cuivre. Autres options de finition voir Lightnet-Surface-Collection ou RAL au choix. Éclairage direct partiel par lentilles de précision avec grille anti-éblouissement pour une large répartition symétrique de l'intensité lumineuse et facteur d'anti-éblouissement très bas (UGR<16). Grille anti-éblouissement disponible en plusieurs combinaisons de couleurs. Composants indirects avec une technologie de lentille innovante pour un éclairage grand angle du plafond. Driver intégré dans le luminaire, au choix ON/OFF ou graduable (DALI). Température de couleur 2700K, 3000K ou 4000K. Binning initial  $\leq$  MacAdam 3. Rendu de couleur CRI>80. Hauteur de suspension selon spécification (min. 450mm).

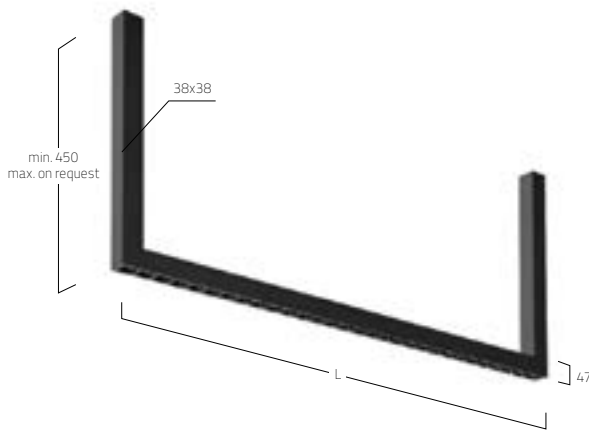

LENS LOUVER DIRECT-INDIRECT

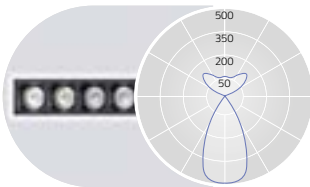

UGR<13 (X=4H, Y=8H, S=0.25H)  
DIRECT: 50% INDIRECT: 50%

L mm	Lumen/Watt Low Power	Lumen/Watt Medium Power
953	3530lm/30W	5830lm/51W
1237	4640lm/38W	7670lm/66W

**PRODUCT-CODE:** L P2 L S E - 8 30 M - L1237 - Q B

PRODUCT FAMILY	L: Matric
TYPE	P2: Direct-Indirect
OPTICAL SYSTEM	L: Lens Louver
SURFACE FINISH	W: Snow White, V: Ivory White, S: Radiant Silver, U: Urban Graphite, B: Jet Black, H: Champagne Silver, K: Satin Copper, A: Satin Silver
CONTROL GEAR	E: On/Off, L: DALI
COLOUR REND.	8: CRI>80
COLOUR TEMP.	27: 2700K, 30: 3000K, 40: 4000K
POWER	E: Low Power, M: Medium Power
SIZE	Luminaire Length in mm: L953, L1237
SUSPENSION	Q: Square Tube Suspension
REFLECTOR	W: Snow White, C: Specular Chrome, B: Jet Black, A: Satin Silver, H: Champagne Silver, K: Satin Copper, N: Satin Platinum, G: Satin Gold





# MATRIC SUSPENDED





POLIS IMMOBILIEN AG, BERLIN, GERMANY  
MATIC-G3

# MATRIC SUSPENDED

ABDA - BUNDESVEREINIGUNG DEUTSCHER  
APOTHEKERVERBÄNDE, BERLIN, GERMANY  
MATRIC-R3  
ENTWURF: REUTER SCHOGER ARCHITEKTUR INNENARCHITEKTUR

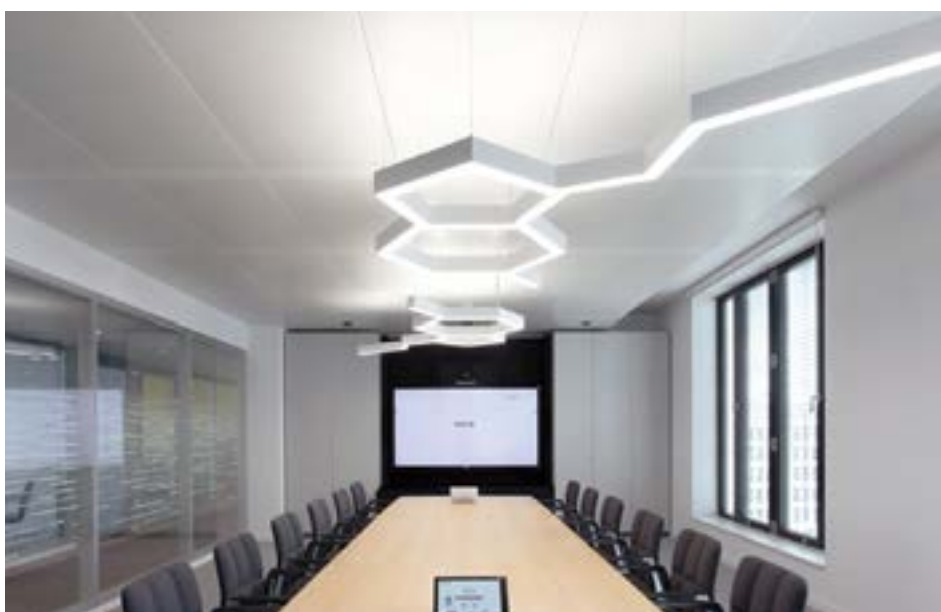
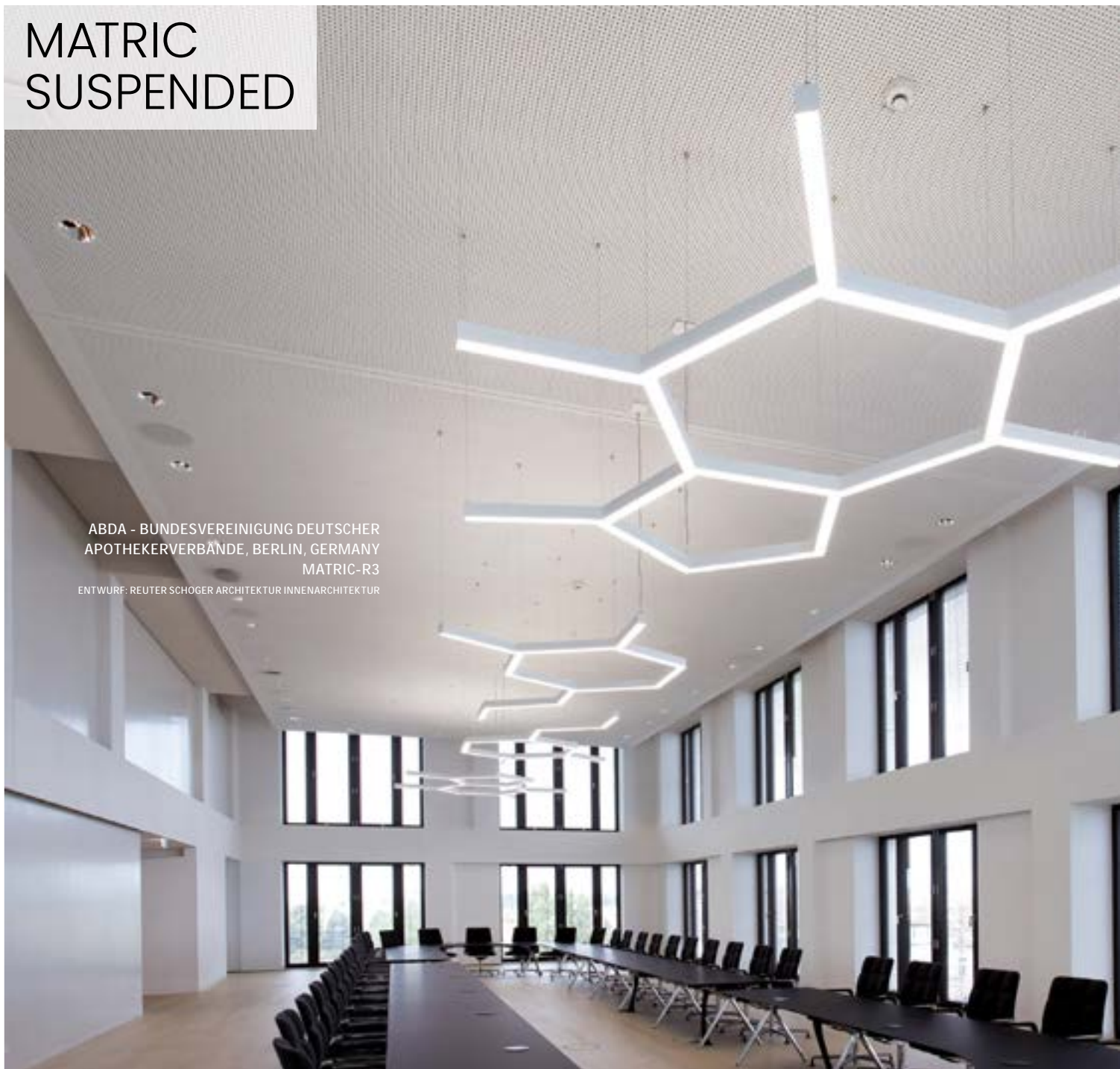

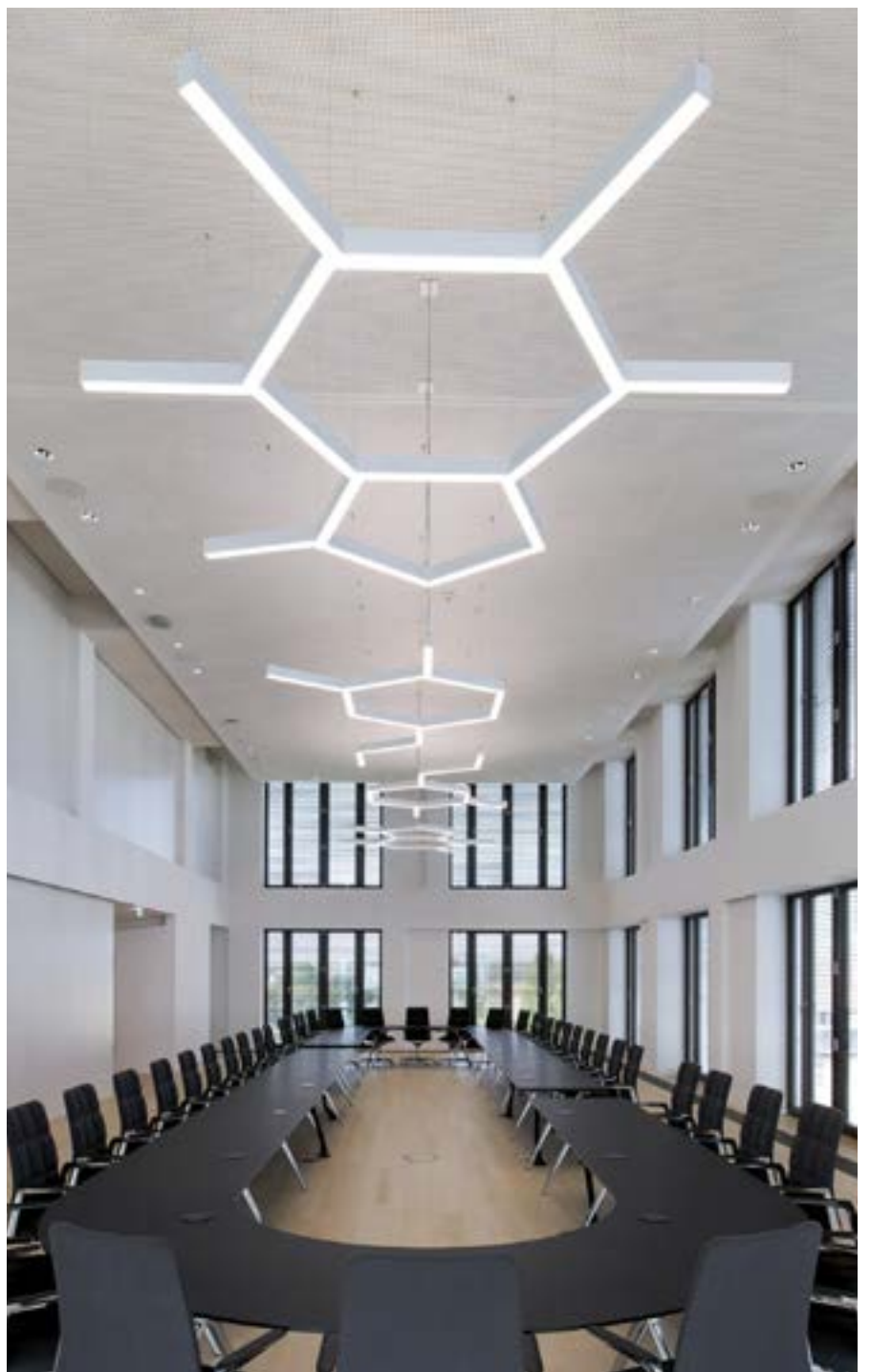

# MATRIC SUSPENDED



FARAGE FLAGSHIP STORE, SYDNEY, AUSTRALIA  
MATRIC-G3



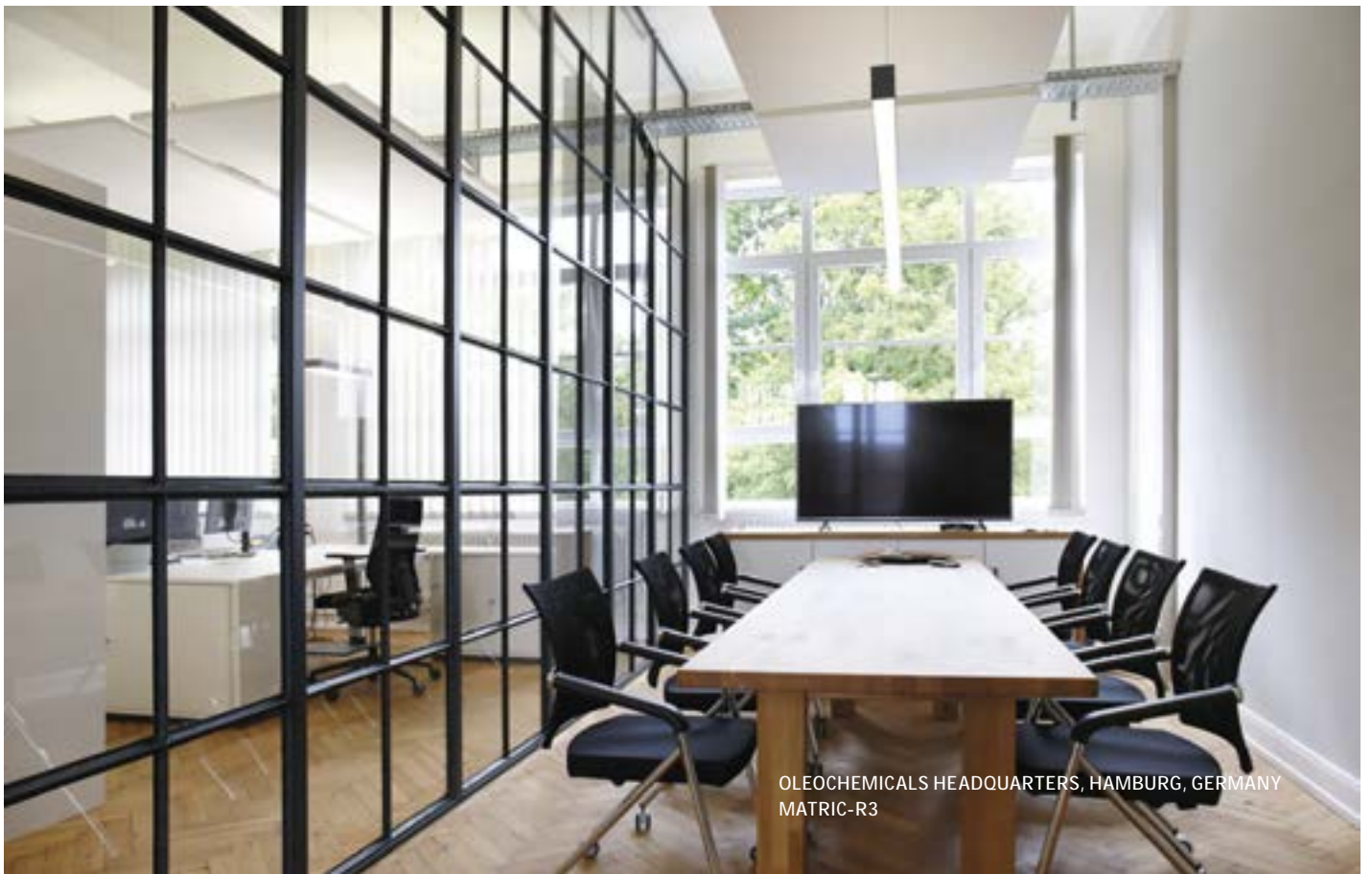

OLEOCHEMICALS HEADQUARTERS, HAMBURG, GERMANY  
MATRIC-R3



FARAGE FLAGSHIP STORE, SYDNEY, AUSTRALIA  
MATRIC-G3

# MATRIC SUSPENDED





AEB UNTERNEHMENSZENTRALE, STUTTGART, GERMANY  
MATRIC-G1

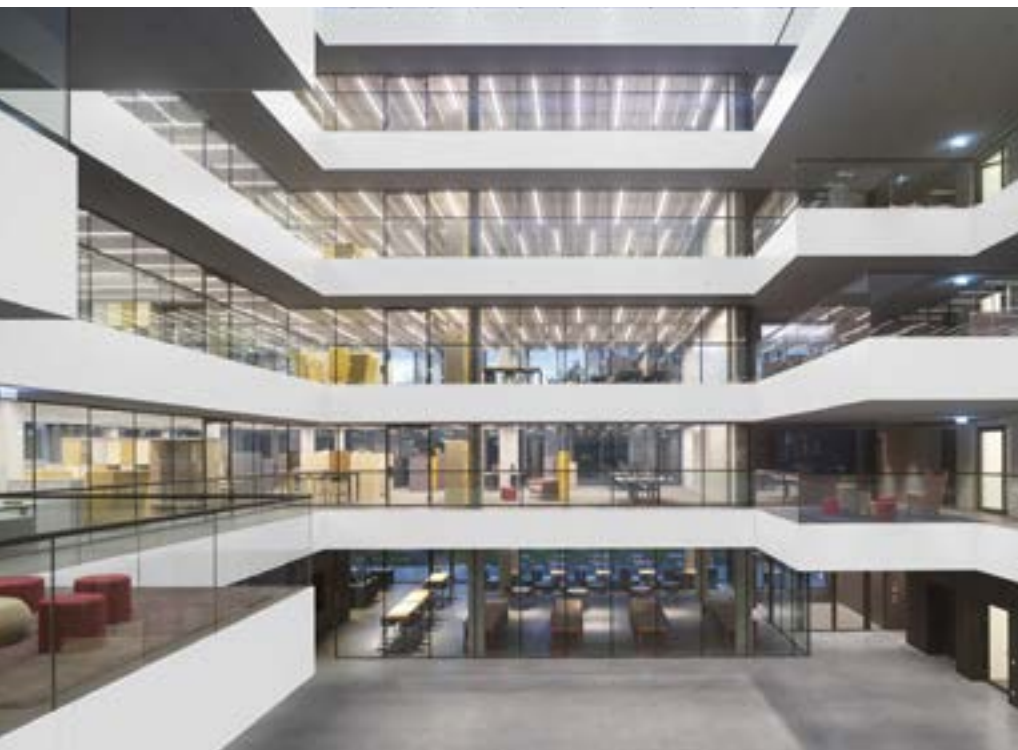



# MATRIC SUSPENDED





VOLKSBANK BIELEFELD-GÜTERSLOH, GERMANY  
MATRIC-R3  
PHOTOS: PATRICK POLLMEIER



CORE MEDIA, DUBLIN, IRELAND  
MATRIC-G3

# MATRIC 38<sub>MM</sub> WORK ZONE SUSPENDED | P1



**DE** LED-Pendelleuchte. Direkt-indirektstrahlend. Lichtkanal aus Aluminiumprofil mit 38mm Lichtspur-Breite. Millimetergenaue Längenfertigung nach Vorgabe möglich. Oberfläche weiß, graphit, schwarz, champagner oder kupferfarben lackiert. Weitere Oberflächenoptionen siehe Lightnet-Surface-Collection oder RAL nach Wahl. Direktanteil über Präzisionslinsen mit Abblenderaster für Office Anwendungen. Raster in verschiedenen Farbausführung erhältlich. Indirektanteil mit innovativer Linsentechnologie für breitstrahlende Deckenaufhellung. Konverter in Leuchtgehäuse integriert, wahlweise einfach schaltbar oder stufenlos dimmbar (DALI). Farbtemperaturen 2700K, 3000K oder 4000K. Binning initial  $\leq$  MacAdam 3. Farbwiedergabe CRI>80. Stufenlos höhenverstellbare Seil-Abhängung oder Pendelrohr.

**EN** LED pendant luminaire. Direct-indirect light distribution. Light channel made of aluminium profile with 38mm profile width. Precise length production according to specifications possible. Surface white, graphite, black, champagne or copper coated. Further surface options see Lightnet-Surface-Collection or RAL of your choice. Direct part using precision lenses with louvre for workplaces. Louvre available in various colour combinations. Indirect light with innovative lens technology for wide-angle ceiling illumination. Driver integrated into luminaire housing, optionally switchable or dimmable (DALI). Colour temperature 2700K, 3000K or 4000K. Binning initial  $\leq$  MacAdam 3. Colour rendering CRI>80. Height adjustable cord suspension or rod suspension.

**FR** Luminaire LED suspendu. Éclairage direct/indirect. Rail lumineux en profilé d'aluminium avec une largeur d'éclairage de 38 mm. Fabrication au millimètre près des longueurs selon les spécifications. Surface laquée blanc, graphite, noir, champagne ou cuivre. Autres options de finition voir Lightnet-Surface-Collection ou RAL au choix. Éclairage direct partiel par lentilles de précision avec grille antiéblouissement pour le poste de travail/bureau. Grille antiéblouissement disponible en plusieurs combinaisons de couleurs. Composants indirects avec une technologie de lentille innovante pour un éclairage grand angle du plafond. Driver intégré dans le luminaire, au choix ON/OFF ou graduable (DALI). Température de couleur 2700K, 3000K ou 4000K. Binning initial  $\leq$  Mac Adam 3. Rendu de couleur CRI>80. Suspension réglable en hauteur ou tige centrale.

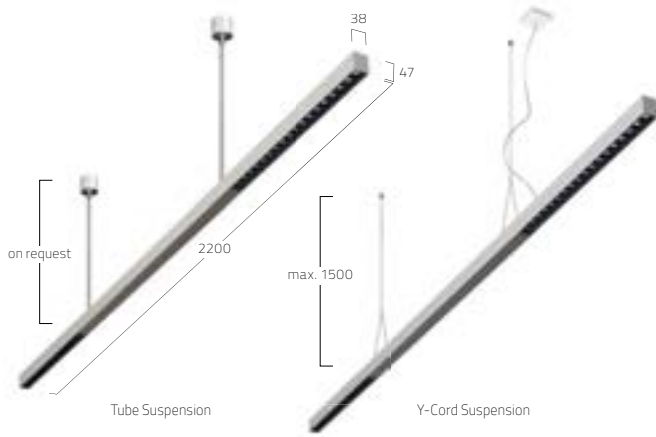

**PRODUCT-CODE:** L P1 L S L - 8 30 M - L2200 - Y B

PRODUCT FAMILY	L: Matric
TYPE	P1: Direct-Indirect
OPTICAL SYSTEM	L: Lens Louver
SURFACE FINISH	W: Snow White, V: Ivory White, S: Radiant Silver U: Urban Graphite, B: Jet Black, H: Champagne Silver, H: Champagne Silver, K: Satin Copper, A: Satin Silver
CONTROL GEAR	E: On/Off, L: DALI
COLOUR REND.	8: CRI>80
COLOUR TEMP.	27: 2700K, 30: 3000K, 40: 4000K
POWER	E: Low Power, M: Medium Power
SIZE	Luminaire Length in mm: L1500, L2200
SUSPENSION	P: Tube Suspension, Y: Y-Cord Suspension
REFLECTOR	W: Snow White, C: Specular Chrome, B: Jet Black, A: Satin Silver, H: Champagne Silver, K: Satin Copper, N: Satin Platinum, G: Satin Gold
ON REQUEST	Cable colour Red or Black

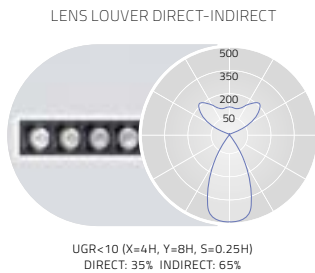

L mm	Lumen/Watt Low Power	Lumen/Watt Medium Power
1500	5120lm/43W	8950lm/78W
2200	6740lm/54W	11210lm/91W

Lumen Values: Luminaire luminous flux at 4000K/CRI>80. Other configurations on request.

IP20 ~220-240V 50-60 Hz IK 02 R60 EN 62471 ≤3 MacAdam LOW POWER 1500lm 50000h MEDIUM POWER 1850lm 50000h CE



MATRIC 38<sub>MM</sub> LENS LOUVER  
SUSPENDED DIRECT | G1



**DE** LED-Pendelleuchte. Rein direktstrahlend. Lichtkanal aus Aluminiumprofil mit 38mm Lichtspur-Breite. Millimetergenaue Längenfertigung nach Vorgabe möglich. Oberfläche natureloxiert oder weiß, graphit, schwarz, champagner oder kupferfarben lackiert. Weitere Oberflächenoptionen siehe Lightnet-Surface-Collection oder RAL nach Wahl. Präzisionslinsen mit Abblendraster für breite rotationssymmetrische Lichtstärkeverteilung bei gleichzeitig hoher Blendungsbegrenzung (UGR<16). Raster in verschiedenen hochwertigen Lackierungen erhältlich. Konverter in Leuchtgehäuse integriert, wahlweise einfach schaltbar oder stufenlos dimmbar (1-10V, DALI, Touch-Dim, Casambi). Farbtemperaturen 2700K, 3000K oder 4000K. Binning initial ≤ MacAdam 3. Colour rendering CRI>80. Stufenlos höhenverstellbare Seilabhängung mit transparent ummantelter Zuleitung.

**EN** LED pendant luminaire. Direct only light distribution. Light channel made of aluminium profile with 38mm track width. Precise length production according to specifications possible. Surface natural anodised or white, graphite, black, champagne or copper coated. Further surface options see Lightnet-Surface-Collection or RAL of your choice. Precision lenses with louvre for wide rotationally symmetrical light distribution with high glare limitation (UGR<16). Louvre available in various high-quality finishes. Converter integrated into luminaire housing, optionally switchable or dimmable (1-10V, DALI, Touch-Dim, Casambi). Colour temperature 2700K, 3000K or 4000K. Binning initial ≤ MacAdam 3. Colour rendering CRI>80. Height-adjustable cord suspension with transparent power supply cable.

**FR** Luminaire LED suspendu. Éclairage seulement direct. Rail lumineux en profilé d'aluminium avec une largeur d'éclairage de 38 mm. Fabrication au millimètre près des longueurs selon les spécifications. Surface anodisée ou laquée blanc, graphite, noir, champagne ou cuivre. Autres options de finition voir Lightnet-Surface-Collection ou RAL au choix. Lentilles de précision avec grille antiéblouissement pour une large répartition symétrique de l'intensité lumineuse et facteur d'antiéblouissement très bas (UGR<16). Grille disponible en différentes finitions de haute qualité. Driver intégré dans le luminaire, au choix ON/OFF ou graduable (1-10V, DALI, Touch-Dim, Casambi). Température de couleur 2700K, 3000K ou 4000K. Binning initial ≤ Mac Adam 3. Rendu de couleur CRI>80. Suspension réglable en hauteur avec câble d'alimentation transparent.

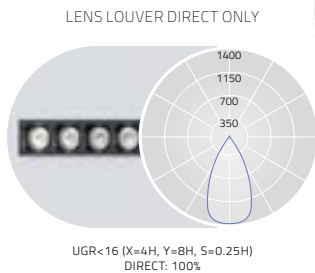
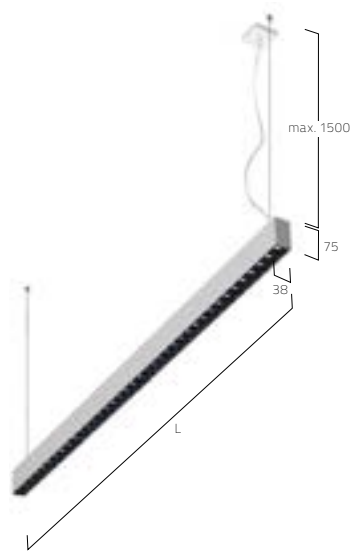

L mm	Lumen/Watt Low Power	Lumen/Watt Medium Power
953	1800lm/20W	2900lm/33W
1237	2340lm/25W	3770lm/42W
1521	2880lm/31W	4640lm/52W
1805	3420lm/36W	5510lm/61W

Lumen Values: Luminaire luminous flux at 4000K/CRI>80. Other configurations on request.

**PRODUCT-CODE: L G1 L E L - 8 30 M - L1805 - A B**

PRODUCT FAMILY	L: Matrix
TYPE	G1: Direct Only
OPTICAL SYSTEM	L: Lens Louver
SURFACE FINISH	W: Snow White, V: Ivory White, E: Silver Anodised, U: Urban Graphite, B: Jet Black, H: Champagne Silver, K: Satin Copper, A: Satin Silver
CONTROL GEAR	E: On/Off, L: DALI, D: 1-10V, H: Touch-Dim, A: Casambi Micro
COLOUR REND.	8: CRI>80
COLOUR TEMP.	27: 2700K, 30: 3000K, 40: 4000K
POWER	E: Low Power, M: Medium Power
SIZE	Luminaire length in mm: L953, L1237, L1521, L1805
SUSPENSION	A: Single Cord Suspension
REFLECTOR	W: Snow White, C: Specular Chrome, B: Jet Black, A: Satin Silver, H: Champagne Silver, K: Satin Copper, N: Satin Platinum, G: Satin Gold
ON REQUEST	Cable colour Red or Black



MATRIC 38 MM  
SUSPENDED DIRECT | G1

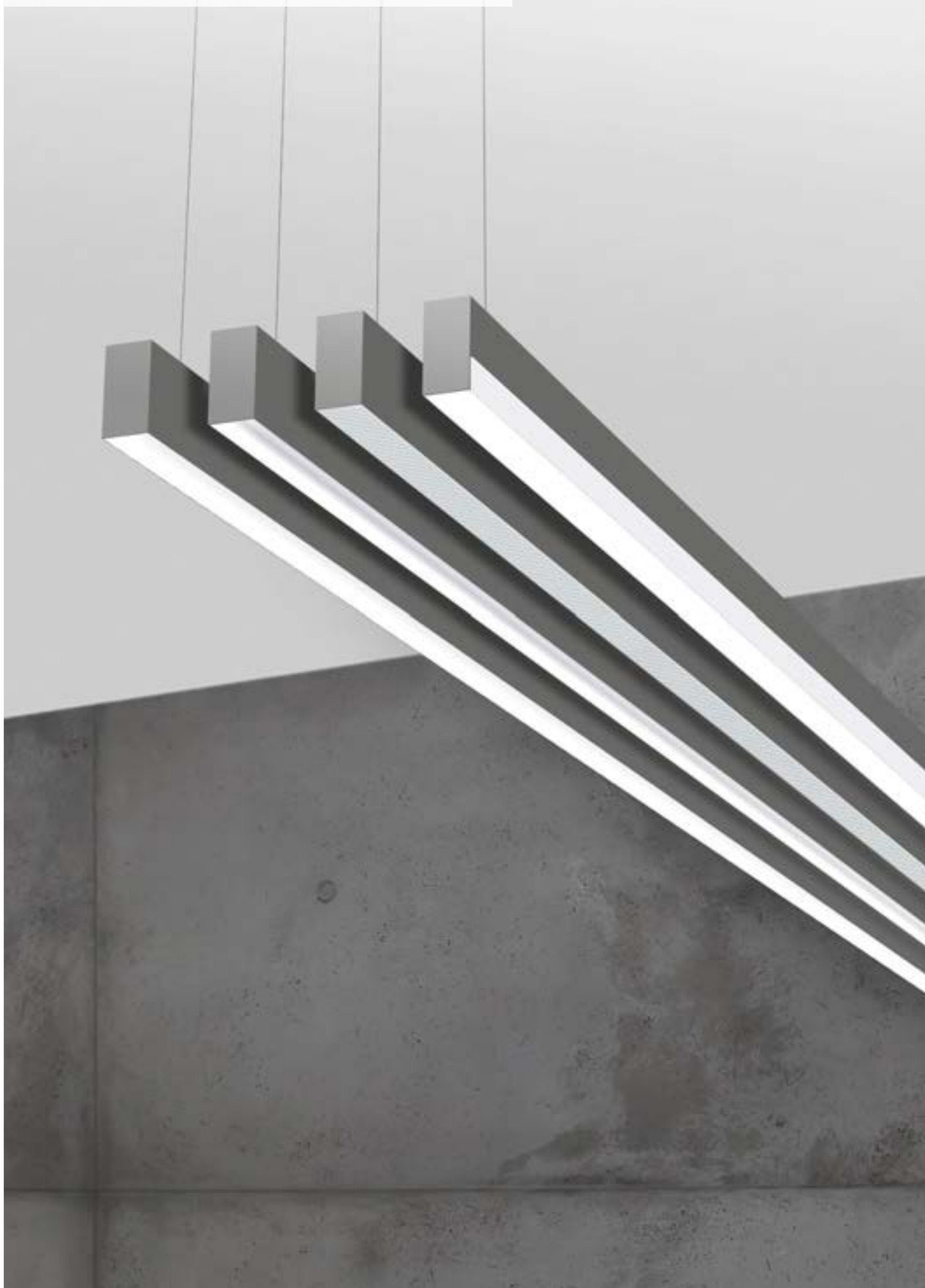

**DE** LED-Pendelleuchte. Rein direktstrahlend. Lichtkanal aus Aluminiumprofil mit 38mm Lichtspur-Breite. Millimetergenaue Längenfertigung nach Vorgabe möglich. Oberfläche naturelxiert oder weiß, graphit, schwarz, champagner oder kupferfarben lackiert. Weitere Oberflächenoptionen siehe Lightnet-Surface-Collection oder RAL nach Wahl. Microprismenoptik mit optimierter Blendungsbegrenzung speziell für Office-Anwendungen. Opaldiffusor aus satiniertem Acrylglas sowie Ambientdiffusor rundumstrahlend für Allgemeinbeleuchtung. Wallwasher für homogene vertikale Beleuchtung. Konverter in Leuchtgehäuse integriert, wahlweise einfach schaltbar oder stufenlos dimmbar (1-10V, DALI, Touch-Dim, Casambi). Farbtemperaturen 2200K, 2700K, 3000K, 3500K, 4000K oder 6500K. Binning initial  $\leq$  MacAdam 3. Farbwiedergabe CRI>80 oder CRI>90. Stufenlos höhenverstellbare Seilabhangung mit transparent ummantelter Zuleitung.

**EN** LED pendant luminaire. Direct only light distribution. Light channel made of aluminium profile with 38mm track width. Precise length production according to specifications possible. Surface natural anodised or white, graphite, black, champagne or copper coated. Further surface options see Lightnet-Surface-Collection or RAL of your choice. Direct part using precision lenses with louvre for wide rotationally symmetrical light distribution with high glare limitation (UGR<16). Louvre available in various colour combinations. Indirect light with innovative lens technology for wide-angle ceiling illumination. Converter integrated into luminaire housing, optionally switchable or dimmable (1-10V, DALI, Touch-Dim, Casambi). Colour temperature 3000K or 4000K. Binning initial  $\leq$  MacAdam 3. Colour rendering CRI>80. Height-adjustable cord suspension with transparent power supply cable.

**FR** Luminaire LED suspendu. Eclairage seulement direct. Rail lumineux en profile d'aluminium avec une largeur d'eclairage de 38 mm. Fabrication au millimetre pres des longueurs selon les specifications. Surface anodisee ou laquee blanc, graphite, noir, champagne ou cuivre. Autres options de finition voir Lightnet-Surface-Collection ou RAL au choix. Diffuseur microprismatique optimise pour un elourissement limite et adapte aux bureaux. Diffuseur opale en verre acrylique satine et diffuseur ambiant avec repartition lumineuse laterale pour diverses applications d'eclairage. Wallwasher pour un eclairage vertical homogene. Driver integre dans le luminaire, au choix ON/OFF ou graduable (1-10V, DALI, Touch-Dim, Casambi). Temperature de couleur 2200K, 2700K, 3000K, 3500K, 4000K ou 6500K. Binning initial  $\leq$  MacAdam 3. Rendu de couleur CRI>80 ou CRI>90. Suspension reglable en hauteur avec cable d'alimentation transparent.

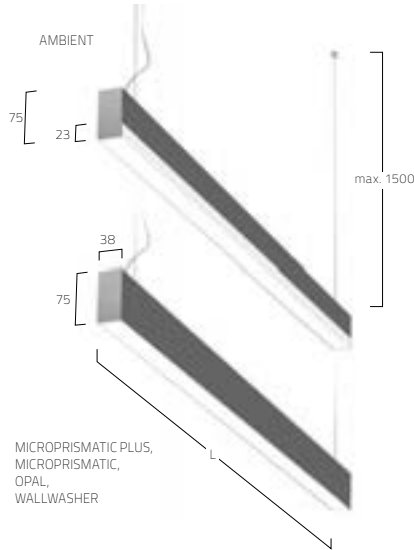

**PRODUCT-CODE:** L G1 A E E - 8 30 M - L1182 - A

PRODUCT FAMILY – L: Matric  
 TYPE – G1: Suspended Direct  
 OPTICAL SYSTEM – H: Microprismatic Plus, A: Microprismatic, O: Opal, F: Ambient, G: Wallwasher  
 SURFACE FINISH – W: Snow White, E: Silver Anodised, U: Urban Graphite, B: Jet Black, H: Champagne Silver, K: Satin Copper  
 CONTROL GEAR – E: On/Off, L: DALI, D: 1-10V, H: Touch-Dim, A: Casambi Micro  
 COLOUR REND. – 8: CRI>80, 9: CRI>90, F: Full Spectrum  
 COLOUR TEMP. – 22: 2200K, 27: 2700K, 30: 3000K, 35: 3500K, 40: 4000K, 65: 6500K, TW: Tunable White 2700-6500K  
 POWER – M: Medium Power, H: High Power  
 SIZE – Luminaire length in mm: L890, L1182, L1475, L1765, L2055  
 SUSPENSION – A: Single Cord Suspension  
 ON REQUEST – Special Length Versions, 90°-Corner, Curve-Elements, Magnetic Track, 3-Phase Track, Midpin Spotlights, Lens Louver-Inset, Emergency Module, Multisensor, Cable colour Red or Black

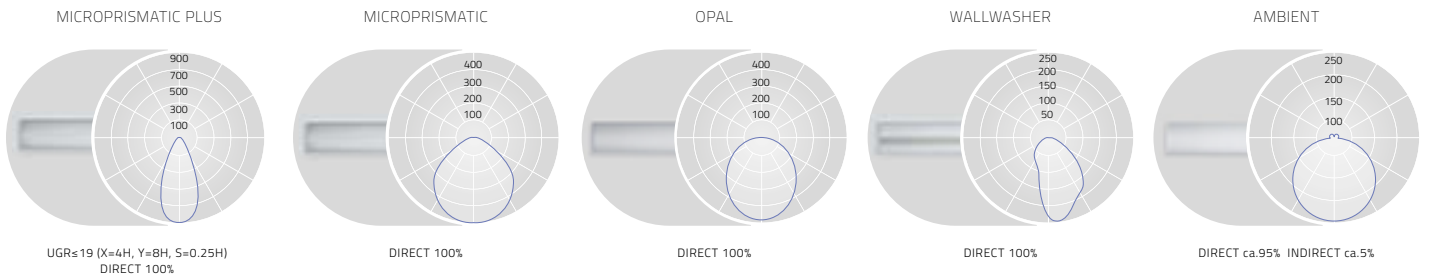

L mm	Lumen/Watt Medium Power	L mm	Lumen/Watt Medium Power	Lumen/Watt High Power	L mm	Lumen/Watt Medium Power	Lumen/Watt High Power	L mm	Lumen/Watt Medium Power	Lumen/Watt High Power	L mm	Lumen/Watt Medium Power	Lumen/Watt High Power
890	1240lm/12W	890	1260lm/13W	1700lm/17W	890	1350lm/13W	1830lm/17W	890	1310lm/13W	1780lm/17W	890	1710lm/13W	2310lm/17W
1182	1650lm/15W	1182	1680lm/16W	2270lm/22W	1182	1810lm/16W	2440lm/22W	1182	1750lm/16W	2370lm/22W	1182	2280lm/16W	3080lm/22W
1475	2060lm/17W	1475	2100lm/20W	2840lm/26W	1475	2260lm/20W	3050lm/26W	1475	2190lm/20W	2960lm/26W	1475	2850lm/20W	3850lm/26W
1765	2480lm/20W	1765	2520lm/23W	3400lm/31W	1765	2710lm/23W	3660lm/31W	1765	2630lm/23W	3550lm/31W	1765	3420lm/23W	4620lm/31W
2055	2880lm/23W	2055	2940lm/26W	3970lm/35W	2055	3160lm/26W	4270lm/35W	2055	3070lm/26W	4140lm/35W	2055	3990lm/26W	5390lm/35W

Lumen Values: Luminaire luminous flux at 4000K/CRI>80. Other configurations on request.





MATRIC 38<sub>MM</sub> LENS LOUVER  
SUSPENDED DIRECT-INDIRECT | R1



**DE** LED-Pendelleuchte. Direkt-indirektstrahlend. Lichtkanal aus Aluminiumprofil mit 38mm Lichtspur-Breite. Millimetergenaue Längenfertigung nach Vorgabe möglich. Oberfläche natureloxiert oder weiß, graphit, schwarz, champagner oder kupferfarben lackiert. Weitere Oberflächenoptionen siehe Lightnet-Surface-Collection oder RAL nach Wahl. Direktanteil über Präzisionslinsen mit Abblenderaster für breite rotationssymmetrische Lichtstärkeverteilung bei gleichzeitig hoher Blendungsbegrenzung (UGR<16). Raster in verschiedenen Farbausführung erhältlich. Indirektanteil mit innovativer Linsentechnologie für breitstrahlende Deckenaufhellung. Konverter in Leuchtgehäuse integriert, wahlweise einfach schaltbar oder stufenlos dimmbar (1-10V, DALI, Touch-Dim, Casambi). Farbtemperaturen 2700K, 3000K oder 4000K. Binning initial  $\leq$  MacAdam 3. Farbwiedergabe CRI>80. Stufenlos höhenverstellbare Seil-Abhängung mit transparent ummantelter Zuleitung.

**EN** LED pendant luminaire. Direct-indirect light distribution. Light channel made of aluminium profile with 38mm track width. Precise length production according to specifications possible. Surface natural anodised or white, graphite, black, champagne or copper coated. Further surface options see Lightnet-Surface-Collection or RAL of your choice. Microprismatic with optimized glare reduction especially for workplaces. Opal diffuser made of acrylic glass and ambient diffuser with omnidirectional light distribution for general lighting. Wallwasher for homogeneous vertical illuminance. Converter integrated into luminaire housing, optionally switchable or dimmable (1-10V, DALI, Touch-Dim, Casambi). Colour temperatures 2700K, 3000K or 4000K. Binning initial  $\leq$  MacAdam 3. Colour rendering CRI>80 or CRI>90. Height-adjustable cord suspension with transparent power supply cable.

**FR** Luminaire LED suspendu. Éclairage direct/indirect. Rail lumineux en profilé d'aluminium avec une largeur d'éclairage de 38 mm. Fabrication au millimètre près des longueurs selon les spécifications. Surface anodisée ou laquée blanc, graphite, noir, champagne ou cuivre. Autres options de finition voir Lightnet-Surface-Collection ou RAL au choix. Éclairage direct partiel par lentilles de précision avec grille antiéblouissement pour une large répartition symétrique de l'intensité lumineuse et facteur d'antiéblouissement très bas (UGR<16). Grille antiéblouissement disponible en plusieurs combinaisons de couleurs. Composants indirects avec une technologie de lentille innovante pour un éclairage grand angle du plafond. Driver intégré dans le luminaire, au choix ON/OFF ou graduable (1-10V, DALI, Touch-Dim, Casambi). Température de couleur 2700K, 3000K ou 4000K. Binning initial  $\leq$  MacAdam 3. Rendu de couleur CRI>80. Suspension réglable en hauteur avec câble d'alimentation transparent.

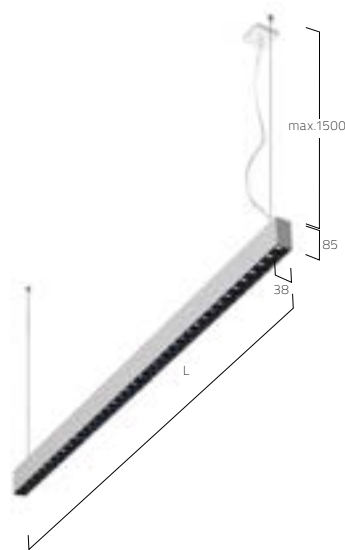

LENS LOUVER DIRECT-INDIRECT

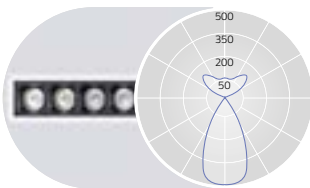

UGR<10 (X=4H, Y=8H, S=0.25H)  
DIRECT: 50% INDIRECT: 50%

L mm	Lumen/Watt Low Power	Lumen/Watt Medium Power
953	3530lm/30W	5830lm/51W
1237	4640lm/38W	7670lm/66W
1521	5760lm/47W	9520lm/81W
1805	6870lm/58W	11360lm/98W

Lumen Values: Luminaire luminous flux at 4000K/CRI>80. Other configurations on request.

**PRODUCT-CODE:** L R1 L E L - 8 30 M - L1805 - Y B

PRODUCT FAMILY	L: Matric
TYPE	R1: Direct-Indirect
OPTICAL SYSTEM	L: Lens Louver
SURFACE FINISH	W: Snow White, V: Ivory White, E: Silver Anodised, U: Urban Graphite, B: Jet Black, H: Champagne Silver, K: Satin Copper, A: Satin Silver
CONTROL GEAR	E: On/Off, L: DALI, D: 1-10V, H: Touch-Dim, A: Casambi Micro
COLOUR REND.	8: CRI>80
COLOUR TEMP.	27: 2700K, 30: 3000K, 40: 4000K
POWER	E: Low Power, M: Medium Power
SIZE	Luminaire Length in mm: L953, L1237, L1521, L1805
SUSPENSION	Y: Y-Cord Suspension
REFLECTOR	W: Snow White, C: Specular Chrome, B: Jet Black, A: Satin Silver, H: Champagne Silver, K: Satin Copper, N: Satin Platinum, G: Satin Gold
ON REQUEST	Cable colour Red or Black



MATRIC 38 MM  
SUSPENDED DIRECT-INDIRECT | R1



**DE** LED-Pendelleuchte. Direkt-indirektstrahlend. Lichtkanal aus Aluminiumprofil mit 38mm Lichtspur-Breite. Millimetergenaue Längenfertigung nach Vorgabe möglich. Oberfläche natureloxiert oder weiß, graphit, schwarz, champagner oder kupferfarben lackiert. Weitere Oberflächenoptionen siehe Lightnet-Surface-Collection oder RAL nach Wahl. Direktanteil über Präzisionslinsen mit Abblenderaster für breite rotationssymmetrische Lichtstärkeverteilung bei gleichzeitig hoher Blendungsbegrenzung (UGR<16). Raster in verschiedenen Farbausführung erhältlich. Indirektanteil mit innovativer Linsentechnologie für breitstrahlende Deckenaufhellung. Konverter in Leuchtgehäuse integriert, wahlweise einfach schaltbar oder stufenlos dimmbar (1-10V, DALI, Touch-Dim, Casambi). Farbtemperaturen 2700K, 3000K oder 4000K. Binning initial  $\leq$  MacAdam 3. Farbwiedergabe CRI>80. Stufenlos höhenverstellbare Seil-Abhängung mit transparent ummantelter Zuleitung.

**EN** LED pendant luminaire. Direct-indirect light distribution. Light channel made of aluminium profile with 38mm profile width. Precise length production according to specifications possible. Surface natural anodised or white, graphite, black, champagne or copper coated. Further surface options see Lightnet-Surface-Collection or RAL of your choice. Microprismatic screen with optimized glare reduction especially for workplaces. Opal diffuser made of acrylic glass and ambient diffuser with omnidirectional light distribution for general lighting. Wallwasher for homogeneous vertical illuminance. Driver integrated into luminaire housing, optionally switchable or dimmable (1-10V, DALI, Touch-Dim, Casambi). Colour temperatures 2700K, 3000K or 4000K. Binning initial  $\leq$  MacAdam 3. Colour rendering CRI>80 or CRI>90. Height-adjustable cord suspension with transparent power supply cable.

**FR** Luminaire LED suspendu. Éclairage direct/indirect. Rail lumineux en profilé d'aluminium avec une largeur d'éclairage de 38 mm. Fabrication au millimètre près des longueurs selon les spécifications. Surface anodisée ou laquée blanc, graphite, noir, champagne ou cuivre. Autres options de finition voir Lightnet-Surface-Collection ou RAL au choix. Éclairage direct partiel par lentilles de précision avec grille antiéblouissement pour une large répartition symétrique de l'intensité lumineuse et facteur d'antiéblouissement très bas (UGR<16). Grille antiéblouissement disponible en plusieurs combinaisons de couleurs. Composants indirects avec une technologie de lentille innovante pour un éclairage grand angle du plafond. Driver intégré dans le luminaire, au choix ON/OFF ou graduable (1-10V, DALI, Touch-Dim, Casambi). Température de couleur 2700K, 3000K ou 4000K. Binning initial  $\leq$  MacAdam 3. Rendu de couleur CRI>80. Suspension réglable en hauteur avec câble d'alimentation transparent.

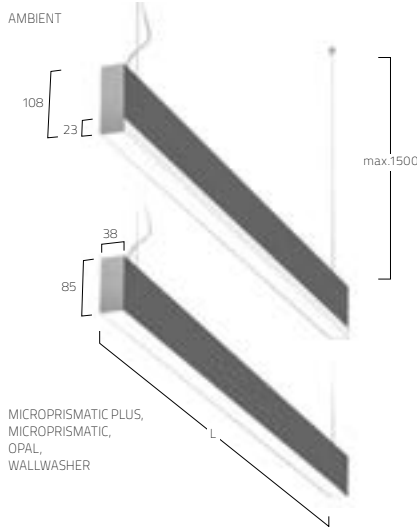

**PRODUCT-CODE:**

**L R I A E E - 8 30 M - L890 - Y**

PRODUCT FAMILY	- L: Matric
TYPE	- <b>R1</b> : Suspended Direct-Indirect
OPTICAL SYSTEM	- <b>H</b> : Microprismatic Plus, <b>A</b> : Microprismatic, <b>O</b> Opal, <b>F</b> : Ambient, <b>G</b> : Wallwasher
SURFACE FINISH	- <b>W</b> : Snow White, <b>E</b> : Silver Anodised, <b>U</b> : Urban Graphite, <b>B</b> : Jet Black, <b>H</b> : Champagne Silver, <b>K</b> : Satin Copper
CONTROL GEAR	- <b>E</b> : On/Off, <b>L</b> : DALI, <b>D</b> : 1-10V, <b>H</b> : Touch-Dim, <b>A</b> : Casambi Micro
COLOUR REND.	- <b>8</b> : CRI>80, <b>9</b> : CRI>90, <b>F</b> : Full Spectrum
COLOUR TEMP.	- <b>22</b> : 2200K, <b>27</b> : 2700K, <b>30</b> : 3000K, <b>35</b> : 3500K, <b>40</b> : 4000K, <b>65</b> : 6500K, <b>TW</b> : Tunable White 2700-6500K
POWER	- <b>M</b> : Medium Power, <b>H</b> : High Power
SIZE	- Luminaire length in mm: <b>L890, L1182, L1475, L1765, L2055</b>
SUSPENSION	- <b>Y</b> : Y-Cord Suspension
ON REQUEST	- Special Length Versions, 90°-Corner, Curve-Elements, Magnetic Track, 3-Phase Track, Midpin Spotlights, Lens Louver-Inset, Emergency Module, Multisensor, Cable colour Red or Black

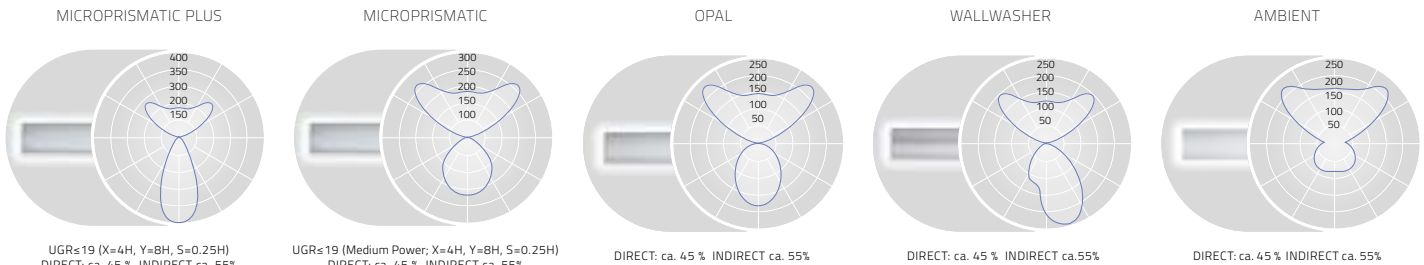

L mm	Lumen/Watt Medium Power	Lumen/Watt High Power	L mm	Lumen/Watt Medium Power	Lumen/Watt High Power	L mm	Lumen/Watt Medium Power	Lumen/Watt High Power	L mm	Lumen/Watt Medium Power	Lumen/Watt High Power	L mm	Lumen/Watt Medium Power	Lumen/Watt High Power
890	2590lm/19W	3970lm/30W	890	2790lm/22W	3780lm/30W	890	2890lm/22W	3910lm/30W	890	2850lm/22W	3850lm/30W	890	2900lm/22W	3910lm/30W
1182	3500lm/25W	5380lm/39W	1182	3790lm/29W	5120lm/39W	1182	3920lm/29W	5300lm/39W	1182	3860lm/29W	5220lm/39W	1182	3920lm/29W	5290lm/39W
1475	4420lm/30W	6790lm/48W	1475	4780lm/35W	6470lm/48W	1475	4940lm/35W	6680lm/48W	1475	4880lm/35W	6590lm/48W	1475	4950lm/35W	6690lm/48W
1765	5340lm/36W	8200lm/58W	1765	5780lm/42W	7810lm/58W	1765	5970lm/42W	8070lm/58W	1765	5890lm/42W	7960lm/58W	1765	5970lm/42W	8080lm/58W
2055	6260lm/42W	9610lm/66W	2055	6770lm/48W	9160lm/66W	2055	7000lm/48W	9460lm/66W	2055	6900lm/48W	9330lm/66W	2055	7000lm/48W	9470lm/66W

Lumen Values: Luminaire luminous flux at 4000K/CRI>80. Other configurations on request.



MATRIC 55 MM  
SUSPENDED DIRECT | G3

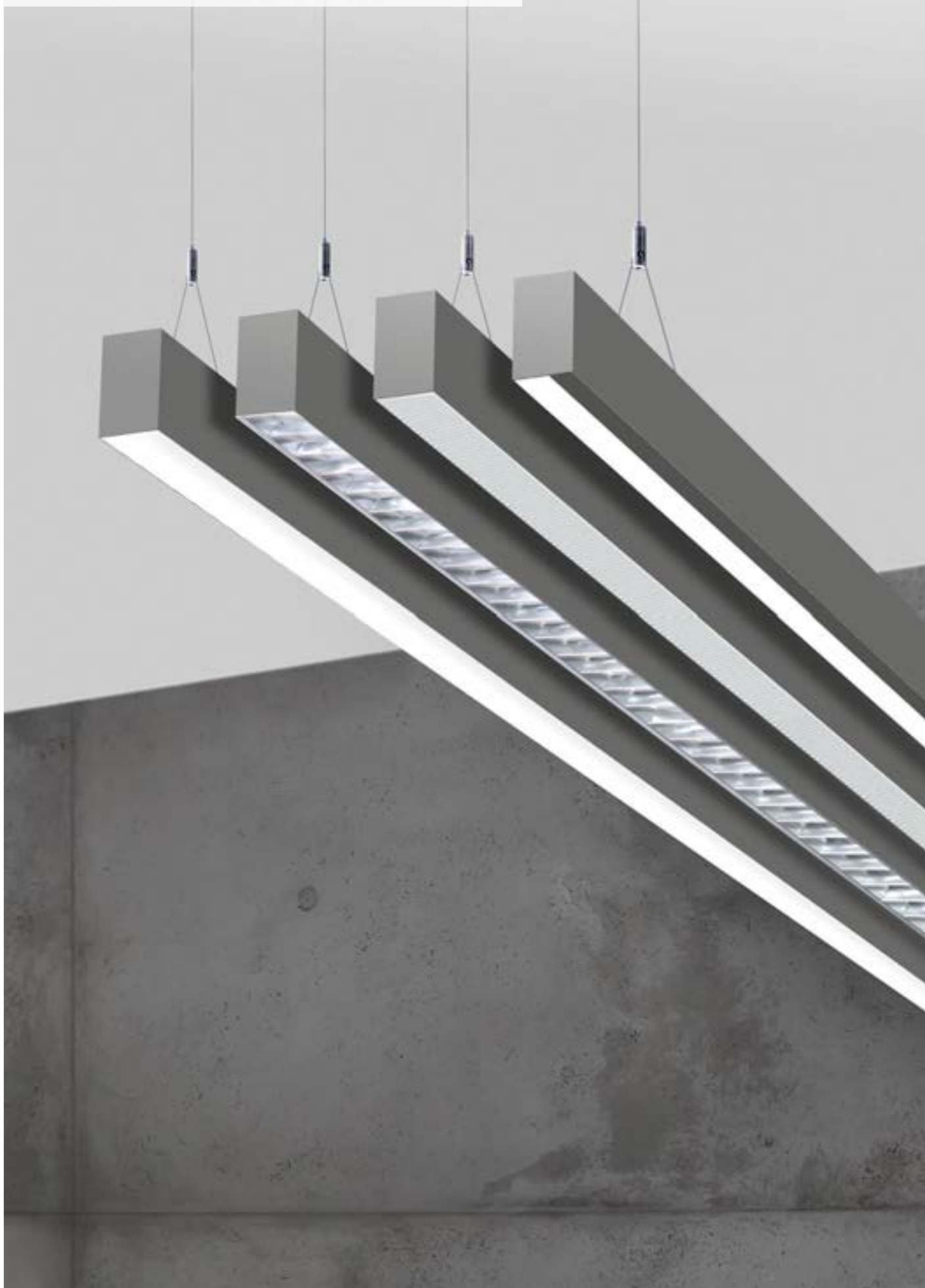

**DE** LED-Pendelleuchte. Rein direktstrahlend. Lichtkanal aus Aluminiumprofil mit 55mm Lichtspur-Breite. Millimetergenaue Längenfertigung nach Vorgabe möglich. Oberfläche naturelxiert oder weiß, graphit, schwarz, champagner oder kupferfarben lackiert. Weitere Oberflächenoptionen siehe Lightnet-Surface-Collection oder RAL nach Wahl. Microprismenoptik und Satin-Louver mit optimierter Blendungsbegrenzung speziell für Office-Anwendungen. Opaldiffusor aus satiniertem Acrylglas für Allgemeinbeleuchtung. Wallwasher für homogene vertikale Beleuchtung. Konverter in Leuchtgehäuse integriert, wahlweise einfach schaltbar oder stufenlos dimmbar (1-10V, DALI, Touch-Dim, Casambi). Farbtemperaturen 2200K, 2700K, 3000K, 3500K, 4000K oder 6500K. Binning initial  $\leq$  MacAdam 3. Farbwiedergabe CRI>80 oder CRI>90. Stufenlos höhenverstellbare Y-Seilabhängung mit transparent ummantelter Zuleitung. Auf Anfrage: Integration von Notlichtkomponenten, Sensortechnologie sowie Vielzahl weiterer Optionen.

**EN** LED pendant luminaire. Direct only light distribution. Light channel made of aluminium profile with 55mm track width. Precise length production according to specifications possible. Surface natural anodised or white, graphite, black, champagne or copper coated. Further surface options see Lightnet-Surface-Collection or RAL of your choice. Microprismatic and satin louver with optimized glare limitation especially for office purposes. Opal diffuser made of acrylic glass for general lighting. Wallwasher for homogeneous vertical illuminance. Converter integrated into luminaire housing, optionally switchable or dimmable (1-10V, DALI, Touch-Dim, Casambi). Colour temperatures 2200K, 2700K, 3000K, 3500K, 4000K or 6500K. Binning initial  $\leq$  MacAdam 3. Colour rendering CRI>80 or CRI>90. Height-adjustable Y-cord suspension with transparent power supply cable. On request: Integration of emergency lighting components, sensor technology as well as many other options.

**FR** Luminaire LED suspendu. Éclairage seulement direct. Rail lumineux en profilé d'aluminium avec une largeur d'éclairage de 55mm. Fabrication au millimètre près des longueurs selon les spécifications. Surface anodisée ou laquée blanc, graphite, noir, champagne ou cuivre. Autres options de finition voir Lightnet-Surface-Collection ou RAL au choix. Diffuseur microprismatique ou Satin-Louver avec une limitation optimisée de l'éblouissement pour les postes de travail. Diffuseur opale en verre acrylique pour éclairage général. Wallwasher pour un éclairage vertical homogène. Driver intégré dans le luminaire, au choix ON/OFF ou graduable (1-10V, DALI, Touch-Dim, Casambi). Température de couleur 2200K, 2700K, 3000K, 3500K, 4000K ou 6500K. Binning initial  $\leq$  MacAdam 3. Rendu de couleur CRI>80 ou CRI>90. Suspension en Y réglable en hauteur avec câble d'alimentation transparent. Sur demande: Intégration de composants d'éclairage de secours ou de capteurs ainsi qu'une multitude d'autres options.

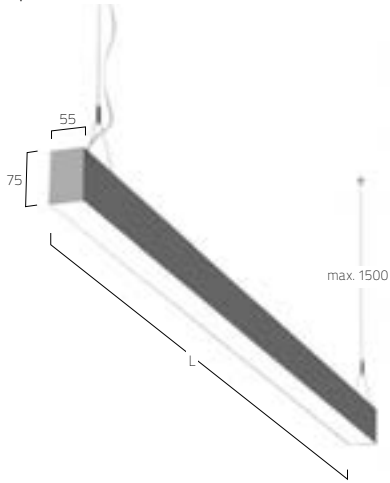

**PRODUCT-CODE:** L G 3 A E E - 8 30 M - L 890 - Y

PRODUCT FAMILY	- L: Matric
TYPE	- G3: Suspended Direct Only
OPTICAL SYSTEM	- O: Opal, A: Microprismatic, M: Satin Louver, G: Wallwasher
SURFACE FINISH	- W: Snow White, E: Silver Anodised, U: Urban Graphite, B: Jet Black, H: Champagne Silver, K: Satin Copper
CONTROL GEAR	- E: On/Off, L: DALI, D: 1-10V, H: Touch-Dim, C: Casambi
COLOUR REND.	- 8: CRI>80, 9: CRI>90, F: Full Spectrum
COLOUR TEMP.	- 22: 2200K, 27: 2700K, 30: 3000K, 35: 3500K, 40: 4000K, 65: 6500K, TW: Tunable White 2700-6500K
POWER	- E: Low Power, M: Medium Power, H: High Power
SIZE	- Luminaire length in mm: L890 L1182 L1475 L1765 L2055
SUSPENSION	- Y: Y Cord Suspension
ON REQUEST	- Special Length Versions, 90° Corner, 3-Phase Track, Midpin Spotlights/Downlights, Emergency Module, Multisensor, Cable colour Red or Black

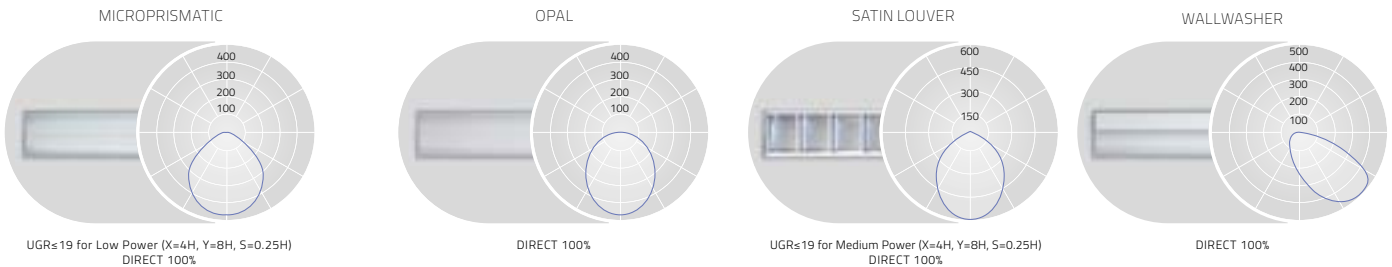

L mm	MICROPRISMATIC			L mm	OPAL			L mm	SATIN LOUVER			L mm	WALLWASHER		
	Lumen/Watt Low Power	Lumen/Watt Medium Power	Lumen/Watt High Power		Lumen/Watt Low Power	Lumen/Watt Medium Power	Lumen/Watt High Power		Lumen/Watt Medium Power	Lumen/Watt High Power	Lumen/Watt Medium Power		Lumen/Watt High Power		
890	1170lm/12W	1950lm/19W	2830lm/28W	890	1250lm/12W	2080lm/19W	3020lm/28W	890	1400lm/19W	2040lm/28W	890	1170lm/16W	1600lm/21W		
1182	1560lm/15W	2600lm/24W	3780lm/36W	1182	1660lm/15W	2770lm/24W	4030lm/36W	1182	1870lm/24W	2720lm/36W	1182	1560lm/20W	2140lm/27W		
1475	1950lm/17W	3250lm/29W	4720lm/44W	1475	2080lm/17W	3470lm/29W	5040lm/44W	1475	2340lm/29W	3400lm/44W	1475	1950lm/24W	2670lm/33W		
1765	2340lm/20W	3900lm/34W	5670lm/52W	1765	2490lm/20W	4160lm/34W	6040lm/52W	1765	2810lm/34W	4080lm/52W	1765	2340lm/28W	3210lm/39W		
2055	2730lm/23W	4550lm/39W	6610lm/58W	2055	2910lm/23W	4850lm/39W	7050lm/58W	2055	3270lm/39W	4760lm/58W	2055	2730lm/31W	3740lm/44W		

Lumen Values: Luminaire luminous flux at 4000K/CRI>80. Other configurations on request.



MATRIC 55 MM  
SUSPENDED DIRECT-INDIRECT | R3

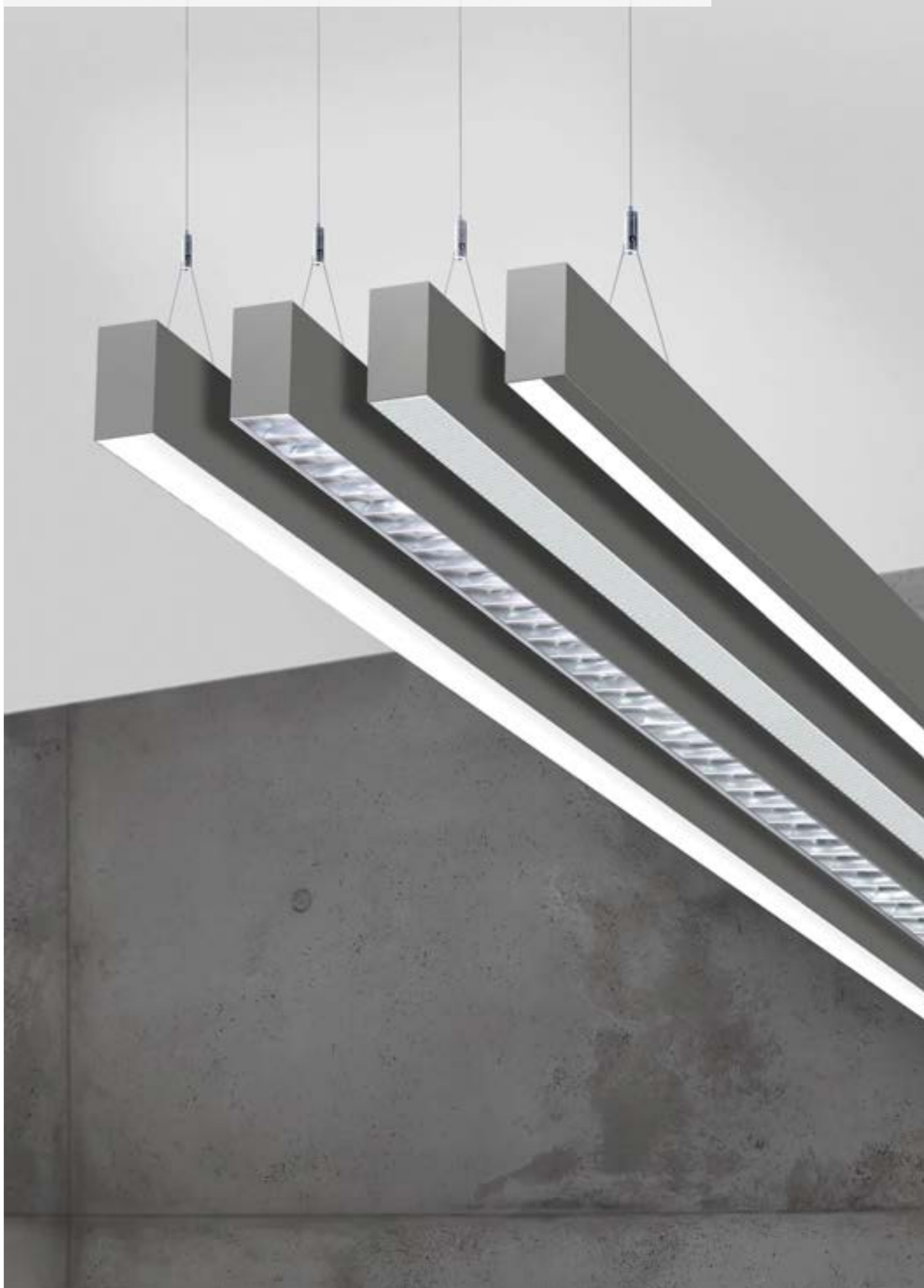

**DE** LED-Pendelleuchte. Direkt-indirektstrahlend. Lichtkanal aus Aluminiumprofil mit 55mm Lichtspur-Breite. Millimetergenaue Längenfertigung nach Vorgabe möglich. Oberfläche natureloxiert oder weiß, graphit, schwarz, champagner oder kupferfarben lackiert. Weitere Oberflächenoptionen siehe Lightnet-Surface-Collection oder RAL nach Wahl. Microprismenoptik und Satin-Louver mit optimierter Blendungsbegrenzung speziell für Office-Anwendungen. Opaldiffusor aus satiniertem Acrylglas für Allgemeinbeleuchtung. Wallwasher für homogene vertikale Beleuchtung. Konverter in Leuchtgehäuse integriert, wahlweise einfach schaltbar oder stufenlos dimmbar (1-10V, DALI, Touch-Dim, Casambi). Farbtemperaturen 2200K, 2700K, 3000K, 3500K, 4000K oder 6500K. Binning initial  $\leq$  MacAdam 3. Farbwiedergabe CRI>80 oder CRI>90. Stufenlos höhenverstellbare Y-Seilabhangung mit transparent ummantelter Zuleitung. Auf Anfrage: Integration von Notlichtkomponenten, Sensortechnologie sowie Vielzahl weiterer Optionen.

**EN** LED pendant luminaire. Direct-indirect light distribution. Light channel made of aluminium profile with 55mm track width. Precise length production according to specifications possible. Surface natural anodised or white, graphite, black, champagne or copper coated. Further surface options see Lightnet-Surface-Collection or RAL of your choice. Microprismatic and satin louver with optimized glare limitation especially for office purposes. Opal diffuser made of acrylic glass for general lighting. Wallwasher for homogeneous vertical illuminance. Converter integrated into luminaire housing, optionally switchable or dimmable (1-10V, DALI, Touch-Dim, Casambi). Colour temperatures 2200K, 2700K, 3000K, 3500K, 4000K or 6500K. Binning initial  $\leq$  MacAdam 3. Colour rendering CRI>80 or CRI>90. Height-adjustable Y-cord suspension with transparent power supply cable. On request: Integration of emergency lighting components, sensor technology as well as many other options.

**FR** Luminaire LED suspendu. clairage direct/indirect. Rail lumineux en profil d'aluminium avec une largeur d'clairage de 55mm. Fabrication au millimtre prs des longueurs selon les spcifications. Surface anodise ou laque blanc, graphite, noir, champagne ou cuivre. Autres options de finition voir Lightnet-Surface-Collection ou RAL au choix. Diffuseur microprismatique ou Satin-Louver avec une limitation optimise de l'blouissement pour les postes de travail. Diffuseur opale en verre acrylique pour clairage gnral. Wallwasher pour un clairage vertical homogne. Driver intgr dans le luminaire, au choix ON/OFF ou graduable (1-10V, DALI, Touch-Dim, Casambi). Temprature de couleur 2200K, 2700K, 3000K, 3500K, 4000K ou 6500K. Binning initial  $\leq$  MacAdam 3. Rendu de couleur CRI>80 ou CRI>90. Suspension en Y rglable en hauteur avec cble d'alimentation transparent. Sur demande: Intgration de composants d'clairage de secours ou de capteurs ainsi qu'une multitude d'autres options.

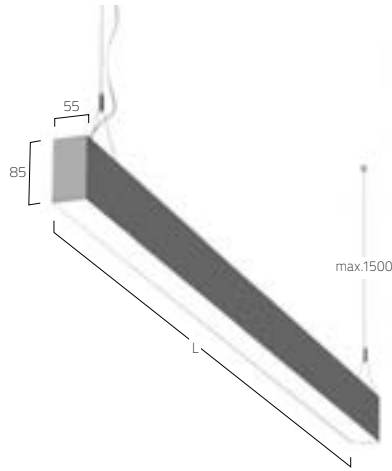

**PRODUCT-CODE:** L R3 A E E - 8 30 M - L890 - Y

- PRODUCT FAMILY – L: Matrix
- TYPE – R3: Suspended Direct-Indirect
- OPTICAL SYSTEM – O: Opal, A: Microprismatic, M: Satin Louver, G: Wallwasher
- SURFACE FINISH – W: Snow White, E: Silver Anodised, U: Urban Graphite, B: Jet Black, H: Champagne Silver, K: Satin Copper
- CONTROL GEAR – E: On/Off, L: DALI, D: 1-10V, H: Touch-Dim, C: Casambi
- COLOUR REND. – 8: CRI>80, 9: CRI>90, F: Full Spectrum
- COLOUR TEMP. – 22: 2200K, 27: 2700K, 30: 3000K, 35: 3500K, 40: 4000K, 65: 6500K, TW: Tunable White 2700-6500K
- POWER – E: Low Power, M: Medium Power, H: High Power
- SIZE – Luminaire length in mm: L890, L1182, L1475, L1765, L2055
- SUSPENSION – Y: Y-Cord Suspension
- ON REQUEST – Special Length Versions, 90° Corner, 3-Phase Track, Midpin Spotlights/Downlights, Emergency Module, Multisensor, Cable colour Red or Black



MICROPRISMATIC

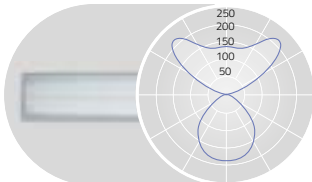

UGR $\leq$ 19 for Low Power (X=4H, Y=8H, S=0.25H)  
DIRECT: ca.50% INDIRECT ca.50%

OPAL

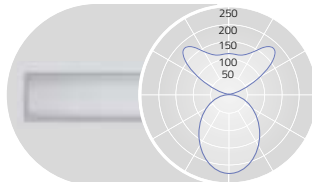

DIRECT: ca.50% INDIRECT ca.50%

SATIN LOUVER

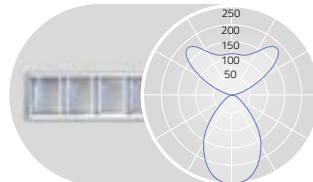

UGR $\leq$ 16 (X=4H, Y=8H, S=0.25H)  
DIRECT: ca.40% INDIRECT ca.60%

WALLWASHER

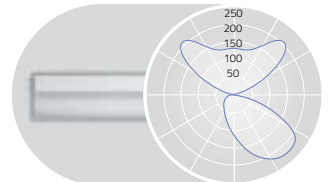

DIRECT: ca.35% INDIRECT ca.65%

L mm	Lumen/Watt Low Power	Lumen/Watt Medium Power	Lumen/Watt High Power
890	2520lm/19W	3850lm/33W	5430lm/47W
1182	3420lm/25W	5210lm/42W	7350lm/61W
1475	4310lm/30W	6570lm/52W	9270lm/75W
1765	5210lm/36W	7930lm/61W	11190lm/89W
2055	6110lm/42W	9290lm/69W	13110lm/100W

L mm	Lumen/Watt Low Power	Lumen/Watt Medium Power	Lumen/Watt High Power
890	2600lm/19W	3980lm/33W	5620lm/47W
1182	3520lm/25W	5380lm/42W	7600lm/61W
1475	4440lm/30W	6790lm/52W	9590lm/75W
1765	5370lm/36W	8190lm/61W	11570lm/89W
2055	6290lm/42W	9590lm/69W	13550lm/100W

L mm	Lumen/Watt Medium Power	Lumen/Watt High Power
890	3300lm/33W	4640lm/47W
1182	4480lm/42W	6300lm/61W
1475	5660lm/52W	7950lm/75W
1765	6840lm/61W	9610lm/89W
2055	8020lm/69W	11260lm/100W

L mm	Lumen/Watt Medium Power	Lumen/Watt High Power
890	3070lm/27W	4200lm/37W
1182	4170lm/34W	5710lm/48W
1475	5270lm/43W	7220lm/61W
1765	6370lm/51W	8730lm/73W
2055	7470lm/60W	10240lm/86W

Lumen Values: Luminaire luminous flux at 4000K/CRI>80. Other configurations on request.



90° CORNER  
OPAL / PRISMATIC



MIDPIN-DOWNLIGHT  
770lm / 11W / 37mm

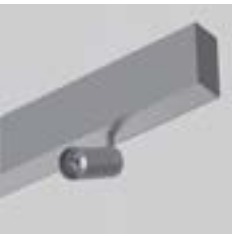

MIDPIN-SINGLE SPOTLIGHT  
770lm / 11W / 37mm

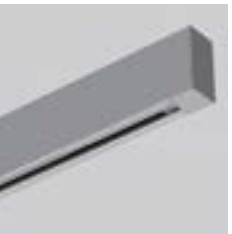

3-PHASE TRACK COMPATIBLE  
WITH GLOBAL-ADAPTORS



MULTISENSOR  
DAYLIGHT & PRESENCE



SNOW WHITE



SILVER ANODISED

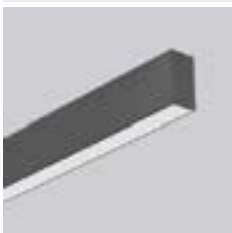

URBAN GRAPHITE



JET BLACK



CHAMPAGNE SILVER



SATIN COPPER



MATRIC 55 MM  
SUSPENDED DIRECT-INDIRECT | R4



**DE** LED-Pendelleuchte. Direkt-indirektstrahlend. Lichtkanal aus Aluminiumprofil mit 55mm Lichtspur-Breite. Millimetergenaue Längenfertigung nach Vorgabe möglich. Oberfläche naturel oxiert oder weiß, graphit, schwarz, champagner oder kupferfarben lackiert. Weitere Oberflächenoptionen siehe Lightnet-Surface-Collection oder RAL nach Wahl. Microprismenoptik und Satin-Louver mit optimierter Blendungsbegrenzung speziell für Office-Anwendungen. Opaldiffusor aus satiniertem Acrylglas für Allgemeinbeleuchtung. Wallwasher für homogene vertikale Beleuchtung. Konverter in Leuchtgehäuse integriert, wahlweise getrennt schaltbar oder zusammen dimmbar (1-10V, DALI, Touch-Dim, Casambi). Farbtemperaturen 2200K, 2700K, 3000K, 3500K, 4000K oder 6500K. Binning initial  $\leq$  MacAdam 3. Farbwiedergabe CRI>80 oder CRI>90. Stufenlos höhenverstellbare Y-Seilabhängung mit transparent ummantelter Zuleitung. Auf Anfrage: Integration von Notlichtkomponenten, Sensortechnologie sowie Vielzahl weiterer Optionen.

**EN** LED pendant luminaire. Direct-indirect light distribution. Light channel made of aluminium profile with 55mm profile width. Precise length production according to specifications possible. Surface natural anodised or white, graphite, black, champagne or copper coated. Further surface options see Lightnet-Surface-Collection or RAL of your choice. Microprismatic and satin louver with optimized glare limitation especially for office purposes. Opal diffuser made of acrylic glass for general lighting. Wallwasher for homogeneous vertical illumination. Driver integrated into luminaire housing, optionally separately switchable or together dimmable (1-10V, DALI, Touch-Dim, Casambi). Colour temperatures 2200K, 2700K, 3000K, 3500K, 4000K or 6500K. Binning initial  $\leq$  MacAdam 3. Colour rendering CRI>80 or CRI>90. Height-adjustable Y-cord suspension with transparent power supply cable. On request: Integration of emergency lighting components, sensor technology as well as many other options.

**FR** Luminaire LED suspendu. Éclairage direct/indirect. Rail lumineux en profilé d'aluminium avec une largeur d'éclairage de 55mm. Fabrication au millimètre près des longueurs selon les spécifications. Surface anodisée ou laquée blanc, graphite, noir, champagne ou cuivre. Autres options de finition voir Lightnet-Surface-Collection ou RAL au choix. Diffuseur microprismatique ou Satin-Louver avec une limitation optimisée de l'éblouissement pour les postes de travail. Diffuseur opale en verre acrylique pour éclairage général. Wallwasher pour un éclairage vertical homogène. Convertisseur intégré dans le boîtier du luminaire, au choix 2 allumages séparés ou dimmable (1-10V, DALI, Touch-Dim, Casambi). Température de couleur 2200K, 2700K, 3000K, 3500K, 4000K ou 6500K. Binning initial  $\leq$  Mac Adam 3. Rendu de couleur CRI>80 ou CRI>90. Suspension en Y réglable en hauteur avec câble d'alimentation transparent. Sur demande: Intégration de composants d'éclairage de secours ou de capteurs ainsi qu'une multitude d'autres options.

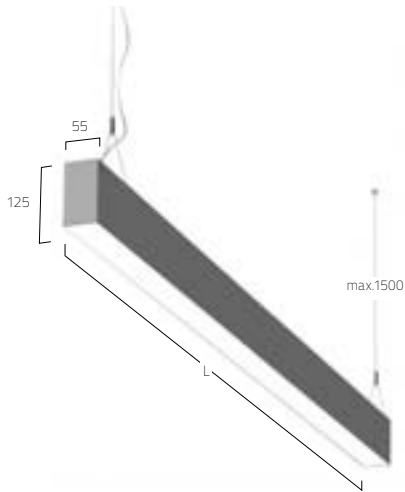

**PRODUCT-CODE:**

**L R4 A E G - 8 30 M - L890 - Y**

PRODUCT FAMILY	- L: Matic
TYPE	- R4: Suspended Direct-Indirect
OPTICAL SYSTEM	- O: Opal, A: Microprismatic, M: Satin Louver, G: Wallwasher
SURFACE FINISH	- W: Snow White, E: Silver Anodise, U: Urban Graphite, B: Jet Black, H: Champagne Silver, K: Satin Copper
CONTROL GEAR	- G: Separately On/Off, L: DALI, D: 1-10V, H: Touch-Dim, C: Casambi
COLOUR REND.	- 8: CRI>80, 9: CRI>90, F: Full Spectrum
COLOUR TEMP.	- 22: 2200K, 27: 2700K, 30: 3000K, 35: 3500K, 40: 4000K, 65: 6500K, TW: Tunable White 2700-6500K
POWER	- E: Low Power, M: Medium Power, H: High Power
SIZE	- Luminaire length in mm: L890, L1182, L1475, L1765, L2055
SUSPENSION	- Y: Y-Cord Suspension
ON REQUEST	- Special Length Versions, 90° Corner, 3-Phase Track, Midpin Spotlights/Downlights, Emergency Module, Multisensor, Cable colour Red or Black



MICROPRISMATIC

OPAL

SATIN LOUVER

WALLWASHER

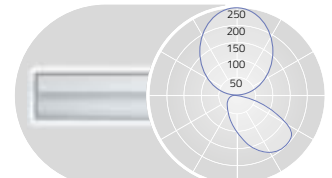
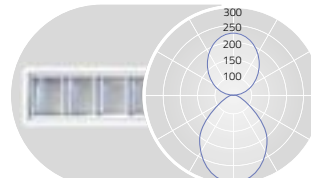
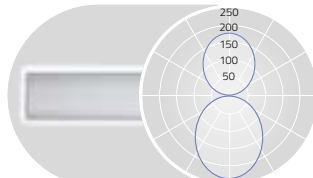
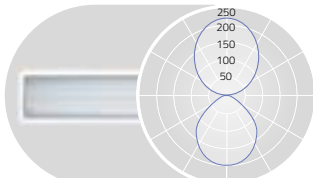

UGR<sub>s</sub>19 for Low Power (X=4H, Y=8H, S=0.25H)  
DIRECT: ca.50% INDIRECT ca.50%

DIRECT: ca.55% INDIRECT ca.45%

UGR<sub>s</sub>16 (X=4H, Y=8H, S=0.25H)  
DIRECT: ca.45% INDIRECT ca.55%

DIRECT: ca.40% INDIRECT ca.60%

L mm	Lumen/Watt Low Power	Lumen/Watt Medium Power	Lumen/Watt High Power
890	2360lm/19W	3620lm/33W	5130lm/47W
1182	3200lm/25W	4900lm/42W	6930lm/61W
1475	4030lm/30W	6180lm/52W	8730lm/75W
1765	4870lm/36W	7450lm/61W	10540lm/89W
2055	5710lm/42W	8730lm/69W	12340lm/100W

L mm	Lumen/Watt Low Power	Lumen/Watt Medium Power	Lumen/Watt High Power
890	2440lm/19W	3750lm/33W	5310lm/47W
1182	3300lm/25W	5070lm/42W	7180lm/61W
1475	4160lm/30W	6390lm/52W	9050lm/75W
1765	5030lm/36W	7710lm/61W	10910lm/89W
2055	5890lm/42W	9030lm/69W	12780lm/100W

L mm	Lumen/Watt Medium Power	Lumen/Watt High Power
890	3080lm/33W	4330lm/47W
1182	4170lm/42W	5870lm/61W
1475	5270lm/52W	7410lm/75W
1765	6360lm/61W	8950lm/89W
2055	7460lm/69W	10490lm/100W

L mm	Lumen/Watt Medium Power	Lumen/Watt High Power
890	2840lm/27W	3900lm/37W
1182	3860lm/34W	5290lm/48W
1475	4880lm/43W	6680lm/61W
1765	5890lm/51W	8080lm/73W
2055	6910lm/60W	9470lm/86W

Lumen Values: Luminaire luminous flux at 4000K/CRI>80. Other configurations on request.



90° CORNER  
OPAL / PRISMATIC

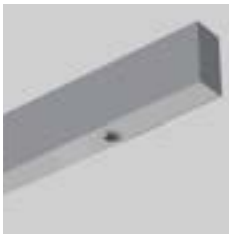

MIDPIN-DOWNLIGHT  
770lm / 11W / Ø37mm

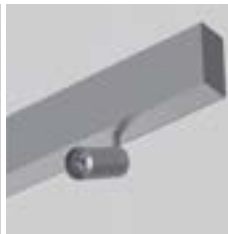

MIDPIN-SINGLE SPOTLIGHT  
770lm / 11W / Ø37mm

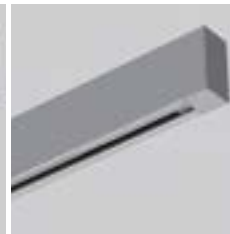

3-PHASE TRACK COMPATIBLE  
WITH GLOBAL-ADAPTORS

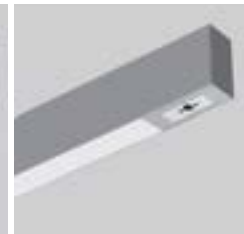

MULTISENSOR  
DAYLIGHT & PRESENCE



SNOW WHITE



SILVER ANODISED



URBAN GRAPHITE



JET BLACK



CHAMPAGNE SILVER



SATIN COPPER

# MATRIC 81 MM SUSPENDED DIRECT | G5



**DE** LED-Pendelleuchte. Rein direktstrahlend. Lichtkanal aus Aluminiumprofil mit 81mm Lichtspur-Breite. Millimetergenaue Längenfertigung nach Vorgabe möglich. Oberfläche naturelxiert oder weiß, graphit, schwarz, champagner oder kupferfarben lackiert. Weitere Oberflächenoptionen siehe Lightnet-Surface-Collection oder RAL nach Wahl. Microprismenoptik und Satin-Louver mit optimierter Blendungsbegrenzung speziell für Office-Anwendungen. Opaldiffusor aus sa-  
 niertem Acrylglas für Allgemeinbeleuchtung. Wallwasher für homogene vertikale Beleuchtung. Konverter in Leuchtgehäuse integriert, wahlweise einfach schaltbar oder stufenlos dimmbar (1-10V, DALI, Touch-Dim, Casambi). Farbtemperaturen 2200K, 2700K, 3000K, 3500K, 4000K oder 6500K. Binning initial  $\leq$  MacAdam 3. Farbwiedergabe CRI>80 oder CRI>90. Stufenlos höhenverstellbare Y-Seilabhangung mit transparent ummantelter Zuleitung. Auf Anfrage: Integration von Notlichtkomponenten, Sensortechnologie sowie Vielzahl weiterer Optionen.

**EN** LED pendant luminaire. Direct only light distribution. Light channel made of aluminium profile with 81mm track width. Precise length production according to specifications possible. Surface natural anodised or white, graphite, black, champagne or copper coated. Further surface options see Lightnet-Surface-Collection or RAL of your choice. Microprismatic and satin louver with optimized glare limitation especially for office purposes. Opal diffuser made of acrylic glass for general lighting. Wallwasher for homogeneous vertical illuminance. Converter integrated into luminaire housing, optionally switchable or dimmable (1-10V, DALI, Touch-Dim, Casambi). Colour temperatures 2200K, 2700K, 3000K, 3500K, 4000K or 6500K. Binning initial  $\leq$  MacAdam 3. Colour rendering CRI>80 or CRI>90. Height-adjustable Y-cord suspension with transparent power supply cable. On request: Integration of emergency lighting components, sensor technology as well as many other options.

**FR** Luminaire LED suspendu. clairage seulement direct. Rail lumineux en profil d'aluminium avec une largeur d'clairage de 81mm. Fabrication au millimetre pres des longueurs selon les specifications. Surface anodisee ou laquee blanc, graphite, noir, champagne ou cuivre. Autres options de finition voir Lightnet-Surface-Collection ou RAL au choix. Diffuseur microprismatique ou Satin-Louver avec une limitation optimisee de l'ebloissement pour les postes de travail. Diffuseur opale en verre acrylique pour clairage general. Wallwasher pour un clairage vertical homogene. Driver integre dans le luminaire, au choix ON/OFF ou graduable (1-10V, DALI, Touch-Dim, Casambi). Temperature de couleur 2200K, 2700K, 3000K, 3500K, 4000K ou 6500K. Binning initial  $\leq$  MacAdam 3. Rendu de couleur CRI>80 ou CRI>90. Suspension en Y reglable en hauteur avec cable d'alimentation transparent. Sur demande: Integration de composants d'clairage de secours ou de capteurs ainsi qu'une multitude d'autres options.

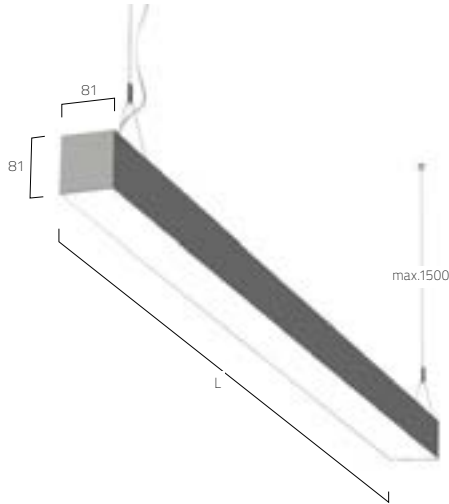

**PRODUCT-CODE:** L G5 A E E - 830 M - L890 - Y

- PRODUCT FAMILY – L: Matrix
- TYPE – G5: Suspended Direct Only
- OPTICAL SYSTEM – A: Microprismatic, O: Opal, M: Satin Louver, G: Wallwasher 1, J: Wallwasher 2
- SURFACE FINISH – W: Snow White, E: Silver Anodised, U: Urban Graphite, B: Jet Black, H: Champagne Silver, K: Satin Copper
- CONTROL GEAR – E: On/Off, L: DALI, D: 1-10V, H: Touch-Dim, C: Casambi
- COLOUR REND. – 8: CRI>80, 9: CRI>90, F: Full Spectrum
- COLOUR TEMP. – 22: 2200K, 27: 2700K, 30: 3000K, 35: 3500K, 40: 4000K, 65: 6500K, TW: Tunable White 2700-6500K
- POWER – E: Low Power, M: Medium Power, H: High Power
- SIZE – Luminaire length in mm: L890, L1182, L1475, L1765, L2055
- SUSPENSION – Y: Y-Cord Suspension
- ON REQUEST – Special Length Versions, 90°-Corner, Midpin Spotlights/Downlights, Emergency Module, Multisensor, Cable colour Red or Black



MICROPRISMATIC

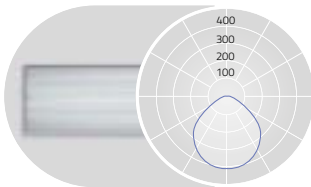

UGR $\leq$ 19 for Low Power (X=4H, Y=8H, S=0.25H)  
DIRECT 100%

OPAL

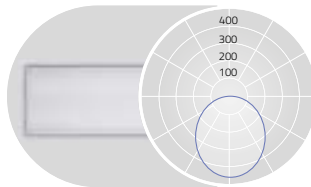

DIRECT 100%

SATIN LOUVER

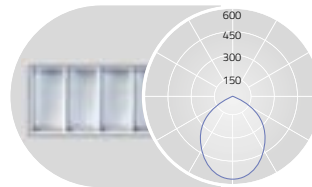

UGR $\leq$ 19 for Medium Power (X=4H, Y=8H, S=0.25H)  
DIRECT 100%

WALLWASHER 1

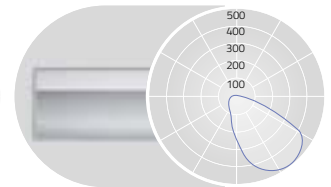

DIRECT 100%

L mm	Lumen/Watt Low Power	Lumen/Watt Medium Power	Lumen/Watt High Power
890	1620lm/14W	2470lm/21W	3280lm/29W
1182	2160lm/18W	3290lm/27W	4370lm/38W
1475	2710lm/22W	4110lm/33W	5470lm/46W
1765	3250lm/25W	4940lm/39W	6560lm/54W
2055	3790lm/29W	5760lm/45W	7650lm/61W

L mm	Lumen/Watt Low Power	Lumen/Watt Medium Power	Lumen/Watt High Power
890	1690lm/14W	2570lm/21W	3420lm/29W
1182	2260lm/18W	3430lm/27W	4560lm/38W
1475	2820lm/22W	4290lm/33W	5700lm/46W
1765	3390lm/25W	5150lm/39W	6840lm/54W
2055	3950lm/29W	6010lm/45W	7980lm/61W

L mm	Lumen/Watt Medium Power	Lumen/Watt High Power
890	1920lm/21W	2570lm/29W
1182	2550lm/27W	3430lm/38W
1475	3190lm/33W	4290lm/46W
1765	3820lm/39W	5150lm/54W
2055	4450lm/45W	6000lm/61W

L mm	Lumen/Watt High Power
890	1840lm/21W
1182	2450lm/27W
1475	3060lm/33W
1765	3670lm/39W
2055	4280lm/44W

WALLWASHER 2

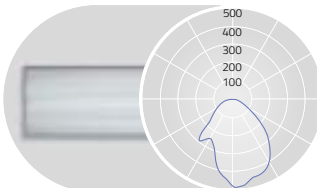

DIRECT: 100%

L mm	Lumen/Watt Medium Power	Lumen/Watt High Power
890	2320lm/21W	3080lm/29W
1182	3090lm/27W	4110lm/38W
1475	3860lm/33W	5130lm/46W
1765	4630lm/39W	6160lm/54W
2055	5410lm/45W	7180lm/61W



Lumen Values: Luminaire luminous flux at 4000K/CRI>80. Other configurations on request.

MATRIC 81 MM  
SUSPENDED DIRECT | G6



**DE** LED-Pendelleuchte. Rein direktstrahlend. Lichtkanal aus Aluminiumprofil mit 81mm Lichtspur-Breite. Millimetergenaue Längenfertigung nach Vorgabe möglich. Oberfläche naturelxiert oder weiß, graphit, schwarz, champagner oder kupferfarben lackiert. Weitere Oberflächenoptionen siehe Lightnet-Surface-Collection oder RAL nach Wahl. Microprismenoptik mit optimierter Blendungsbegrenzung speziell für Office-Anwendungen. Satinierter Opaldiffusor für Allgemeinbeleuchtung. Konverter in Leuchtgehäuse integriert, wahlweise einfach schaltbar oder stufenlos dimmbar (1-10V, DALI, Touch-Dim). Farbtemperaturen 2200K, 2700K, 3000K, 3500K, 4000K oder 6500K. Binning initial  $\leq$  MacAdam 3. Farbwiedergabe CRI>80 oder CRI>90. Stufenlos höhenverstellbare Y-Seilabhängung mit transparent ummantelter Zuleitung. Auf Anfrage: Integration von Notlichtkomponenten, Sensortechnologie sowie Vielzahl weiterer Optionen.

**EN** LED pendant luminaire. Direct only light distribution. Light channel made of aluminium profile with 81mm track width. Precise length production according to specifications possible. Surface natural anodised or white, graphite, black, champagne or copper coated. Further surface options see Lightnet-Surface-Collection or RAL of your choice. Microprismatic with optimized glare reduction especially for workplaces. Satin opal diffuser for general lighting. Converter integrated into luminaire housing, optionally switchable or dimmable (1-10V, DALI, Touch-Dim). Colour temperatures 2200K, 2700K, 3000K, 3500K, 4000K or 6500K. Binning initial  $\leq$  MacAdam 3. Colour rendering CRI>80 or CRI>90. Height-adjustable Y-cord suspension with transparent power supply cable. On request: Integration of emergency lighting components, sensor technology as well as many other options.

**FR** Luminaire LED suspendu. Éclairage seulement direct. Rail lumineux en profilé d'aluminium avec une largeur d'éclairage de 81mm. Fabrication au millimètre près des longueurs selon les spécifications. Surface anodisée ou laquée blanc, graphite, noir, champagne ou cuivre. Autres options de finition voir Lightnet-Surface-Collection ou RAL au choix. Diffuseur microprismatique optimisé pour un éblouissement limité et adapté aux bureaux. Diffuseur opale satinée pour un éclairage général. Driver intégré dans le luminaire, au choix ON/OFF ou graduable (1-10V, DALI, Touch-Dim). Température de couleur 2200K, 2700K, 3000K, 3500K, 4000K ou 6500K. Binning initial  $\leq$  MacAdam 3. Rendu de couleur CRI>80 ou CRI>90. Suspension en Y réglable en hauteur avec câble d'alimentation transparent. Sur demande: Intégration de composants d'éclairage de secours ou de capteurs ainsi qu'une multitude d'autres options.

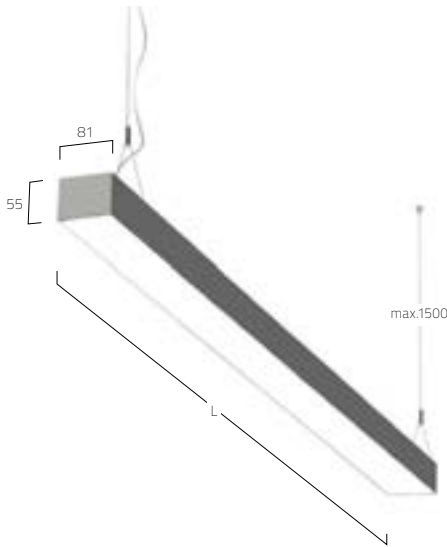

PRODUCT-CODE:	L G 6 A E E - 8 30 M - L 890 - Y
PRODUCT FAMILY	- L: Matric
TYPE	- G6: Suspended Direct Only
OPTICAL SYSTEM	- O: Opal, A: Microprismatic
SURFACE FINISH	- W: Snow White, E: Silver Anodised, U: Urban Graphite, B: Jet Black, H: Champagne Silver, K: Satin Copper
CONTROL GEAR	- E: On/Off, L: DALI, D: 1-10V, H: Touch-Dim
COLOUR REND.	- 8: CRI>80, 9: CRI>90, F: Full Spectrum
COLOUR TEMP.	- 22: 2200K, 27: 2700K, 30: 3000K, 35: 3500K, 40: 4000K, 65: 6500K, TW: Tunable White 2700-6500K
POWER	- E: Low Power, M: Medium Power, H: High Power
SIZE	- Luminaire length in mm: L890, L1182, L1475, L1765, L2055
SUSPENSION	- Y: Y-Cord Suspension
ON REQUEST	- Special Length Versions, 90°-Corner [Blind], Midpin Spotlights/Downlights, Emergency Module, Multisensor, Cable colour Red or Black



MICROPRISMATIC

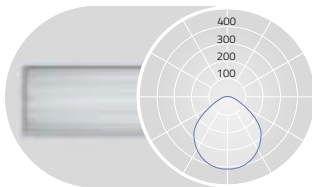

UGR $\leq$ 19 for Low Power (X=4H, Y=8H, S=0.25H)  
DIRECT 100%

OPAL

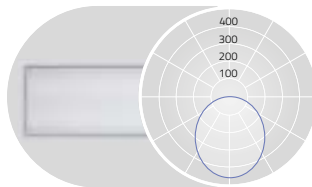

DIRECT 100%

L mm	Lumen/Watt Low Power	Lumen/Watt Medium Power	Lumen/Watt High Power	L mm	Lumen/Watt Low Power	Lumen/Watt Medium Power	Lumen/Watt High Power
890	1630lm/14W	2490lm/21W	3300lm/29W	890	1790lm/14W	2740lm/21W	3660lm/29W
1182	2170lm/18W	3320lm/27W	4440lm/37W	1182	2390lm/18W	3650lm/27W	4890lm/37W
1475	2720lm/22W	4150lm/33W	5510lm/45W	1475	2990lm/22W	4570lm/33W	6110lm/45W
1765	3260lm/25W	4980lm/38W	6630lm/53W	1765	3580lm/25W	5480lm/38W	7330lm/53W
2055	3800lm/28W	5810lm/44W	7750lm/60W	2055	4180lm/28W	6390lm/44W	8550lm/60W

Lumen Values: Luminaire luminous flux at 4000K/CRI>80. Other configurations on request.



MATRIC 81 MM  
SUSPENDED DIRECT-INDIRECT | R6



**DE** LED-Pendelleuchte. Direkt-indirektstrahlend. Lichtkanal aus Aluminiumprofil mit 81mm Lichtspur-Breite. Millimetergenaue Längenfertigung nach Vorgabe möglich. Oberfläche naturelxiert oder weiß, graphit, schwarz, champagner oder kupferfarben lackiert. Weitere Oberflächenoptionen siehe Lightnet-Surface-Collection oder RAL nach Wahl. Microprismenoptik mit optimierter Blendungsbegrenzung speziell für Office-Anwendungen. Satinierter Opaldiffusor für Allgemeinbeleuchtung. Konverter in Leuchtgehäuse integriert, wahlweise einfach schaltbar oder stufenlos dimmbar (1-10V, DALI, Touch-Dim). Farbtemperaturen 2200K, 2700K, 3000K, 3500K, 4000K oder 6500K. Binning initial  $\leq$  MacAdam 3. Colour rendering CRI>80 oder CRI>90. Stufenlos höhenverstellbare Y-Seilabhängung mit transparent ummantelter Zuleitung. Auf Anfrage: Integration von Notlichtkomponenten, Sensortechnologie sowie Vielzahl weiterer Optionen.

**EN** LED pendant luminaire. Direct-indirect light distribution. Light channel made of aluminium profile with 81mm profile width. Precise length production according to specifications possible. Surface natural anodised or white, graphite, black, champagne or copper coated. Further surface options see Lightnet-Surface-Collection or RAL of your choice. Microprismatic with optimized glare reduction especially for workplaces. Satin opal diffuser for general lighting. Driver integrated into luminaire housing, optionally switchable or dimmable (1-10V, DALI, Touch-Dim). Colour temperatures 2200K, 2700K, 3000K, 3500K, 4000K or 6500K. Binning initial  $\leq$  MacAdam 3. Colour rendering CRI>80 or CRI>90. Height-adjustable Y-cord suspension with transparent power supply cable. On request: Integration of emergency lighting components, sensor technology as well as many other options.

**FR** Luminaire LED suspendu. Éclairage direct/indirect. Rail lumineux en profilé d'aluminium avec une largeur d'éclairage de 81mm. Fabrication au millimètre près des longueurs selon les spécifications. Surface anodisée ou laquée blanc, graphite, noir, champagne ou cuivre. Autres options de finition voir Lightnet-Surface-Collection ou RAL au choix. Diffuseur microprismatique optimisé pour un éblouissement limité et adapté aux bureaux. Diffuseur opale satinée pour un éclairage général. Driver intégré dans le luminaire, au choix ON/OFF ou graduable (1-10V, DALI, Touch-Dim). Température de couleur 2200K, 2700K, 3000K, 3500K, 4000K ou 6500K. Binning initial  $\leq$  MacAdam 3. Rendu de couleur CRI>80 ou CRI>90. Suspension en Y réglable en hauteur avec câble d'alimentation transparent. Sur demande: Intégration de composants d'éclairage de secours ou de capteurs ainsi qu'une multitude d'autres options.

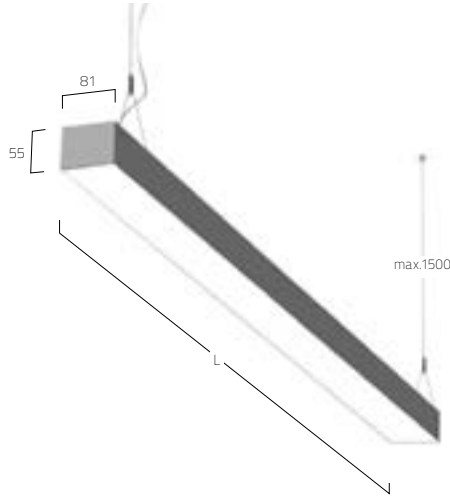

**PRODUCT-CODE:** L R 6 A E E - 8 30 M - L890 - Y

- PRODUCT FAMILY – L: Matrix
- TYPE – R6: Susp. Direct-Indirect
- OPTICAL SYSTEM – O: Opal, A: Microprismatic
- SURFACE FINISH – W: Snow White, E: Silver Anodised, U: Urban Graphite, B: Jet Black, H: Champagne Silver, K: Satin Copper
- CONTROL GEAR – E: On/Off, L: DALI, D: 1-10V, H: Touch-Dim
- COLOUR REND. – 8: CRI>80, 9: CRI>90, F: Full Spectrum
- COLOUR TEMP. – 22: 2200K, 27: 2700K, 30: 3000K, 35: 3500K, 40: 4000K, 65: 6500K, TW: Tunable White 2700-6500K
- POWER – E: Low Power, M: Medium Power, H: High Power
- SIZE – Luminaire length in mm: L890, L1182, L1475, L1765, L2055
- SUSPENSION – Y: Y-Cord Suspension
- ON REQUEST – Special Length Versions, 90°-Corner [Blind], Midpin Spotlights/Downlights, Emergency Module, Multisensor, Cable colour Red or Black



MICROPRISMATIC

OPAL

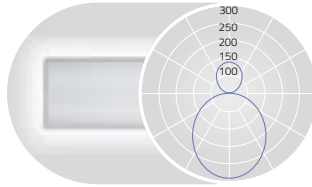
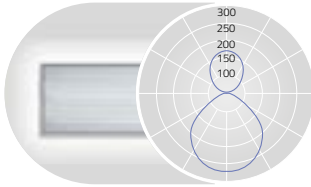

UGR<sub>s19</sub> for Low Power (X=4H, Y=8H, S=0.25H)  
DIRECT: ca. 60% INDIRECT ca. 40%

DIRECT: ca.65% INDIRECT ca.35%

L mm	Lumen/Watt Low Power	Lumen/Watt Medium Power	Lumen/Watt High Power
890	2680lm/25W	3960lm/35W	5350lm/48W
1182	3610lm/32W	5340lm/45W	7210lm/62W
1475	4550lm/38W	6720lm/56W	9080lm/76W
1765	5480lm/44W	8100lm/65W	10940lm/90W
2055	6420lm/50W	9490lm/74W	12810lm/102W

L mm	Lumen/Watt Low Power	Lumen/Watt Medium Power	Lumen/Watt High Power
890	2840lm/25W	4210lm/35W	5680lm/48W
1182	3830lm/32W	5670lm/45W	7650lm/62W
1475	4820lm/38W	7140lm/56W	9630lm/76W
1765	5810lm/44W	8600lm/65W	11610lm/90W
2055	6800lm/50W	10060lm/74W	13580lm/102W

Lumen Values: Luminaire luminous flux at 4000K/CRI>80. Other configurations on request.

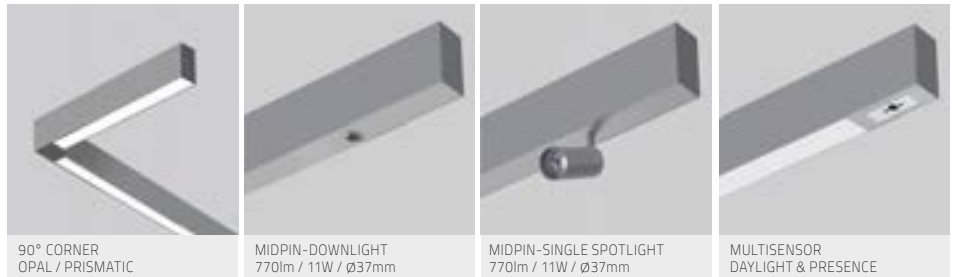



VISION  
SUSPENDED DIRECT-INDIRECT | G2/P2



**DE** LED-Pendelleuchte. Direkt-indirekt oder rein direktstrahlend. Lichtkanal aus Aluminiumprofil mit 130mm Breite. Millimetergenaue Längenfertigung nach Vorgabe möglich. Oberfläche natureloxiert oder weiß, graphit, schwarz, champagner oder kupferfarben lackiert. Weitere Oberflächenoptionen siehe Lightnet-Surface-Collection oder RAL nach Wahl. Microprismenoptik und Satin Louver für Office-Anwendungen. Opaldiffusor aus satiniertem Acrylglas für Allgemeinbeleuchtung. Wallwasher für homogene vertikale Beleuchtung. Konverter in Leuchtgehäuse integriert, wahlweise einfach schaltbar oder stufenlos dimmbar (1-10V, DALI, Touch-Dim, Casambi). Farbtemperaturen 2200K, 2700K, 3000K, 3500K, 4000K oder 6500K. Binning initial  $\leq$  MacAdam 3. Farbwiedergabe CRI>80 oder CRI>90. Stufenlos höhenverstellbare Y-Seilabhängung mit transparent ummantelter Zuleitung. Auf Anfrage: Integration von Notlichtkomponenten.

**EN** LED pendant luminaire. Direct-indirect or Direct Only light distribution. Light channel made of aluminium profile with 130mm width. Precise length production according to specifications possible. Surface natural anodised or white, graphite, black, champagne or copper coated. Further surface options see Lightnet-Surface-Collection or RAL of your choice. Microprismatic and satin louver for office purposes. Opal diffuser made of acrylic glass for general lighting. Wallwasher for homogeneous vertical illuminance. Converter integrated into luminaire housing, optionally switchable or dimmable (1-10V, DALI, Touch-Dim, Casambi). Colour temperatures 2200K, 2700K, 3000K, 3500K, 4000K or 6500K. Binning initial  $\leq$  MacAdam 3. Colour rendering CRI>80 or CRI>90. Height-adjustable Y-cord suspension with transparent power supply cable. On request: Integration of emergency lighting components.

**FR** Luminaire LED suspendu. Éclairage direct/indirect ou seulement direct. Rail lumineux en profilé d'aluminium avec largeur de 130mm. Fabrication au millimètre près des longueurs selon les spécifications. Surface anodisée ou laquée blanc, graphite, noir, champagne ou cuivre. Autres options de finition voir Lightnet-Surface-Collection ou RAL au choix. Optique microprismatique et satin louver pour postes de travail. Diffuseur opale en verre acrylique pour éclairage général. Wallwasher pour un éclairage vertical homogène. Driver intégré dans le luminaire, au choix ON/OFF ou graduable (1-10V, DALI, Touch-Dim, Casambi). Température de couleur 2200K, 2700K, 3000K, 3500K, 4000K ou 6500K. Binning initial  $\leq$  MacAdam 3. Rendu de couleur CRI>80 ou CRI>90. Suspension en Y réglable en hauteur avec câble d'alimentation transparent. Sur demande: Intégration de composants d'éclairage de secours

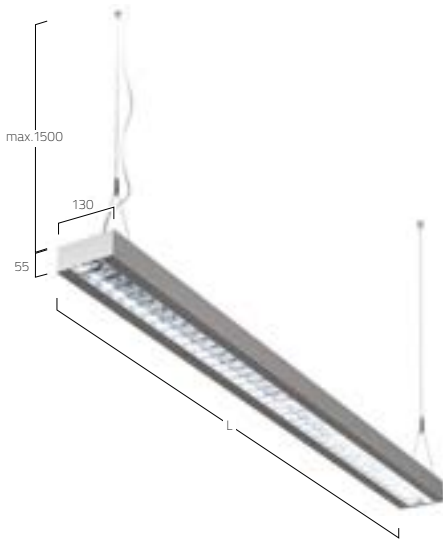

**PRODUCT-CODE:** **V P 2 A E E - 8 30 M - L890 - Y**

PRODUCT FAMILY	- V: Vision
TYPE	- G2: Direct, P2: Direct-Indirect
OPTICAL SYSTEM	- O: Opal, A: Microprismatic, M: Satin Louver, G: Wallwasher
SURFACE FINISH	- W: Snow White, E: Silver Anodised, U: Urban Graphite, B: Jet Black, H: Champagne Silver, K: Satin Copper
CONTROL GEAR	- E: On/Off, L: DALI, D: 1-10V, H: Touch-Dim, C: Casambi
COLOUR REND.	- 8: CRI>80, 9: CRI>90, F: Full Spectrum
COLOUR TEMP.	- 22: 2200K, 27: 2700K, 30: 3000K, 35: 3500K, 40: 4000K, 65: 6500K, TW: Tunable White 2700-6500K
POWER	- M: Medium Power, H: High Power
SIZE	- Luminaire length in mm: L890, L1182, L1475, L1765, L2055
SUSPENSION	- Y: Y-Cord Suspension
ON REQUEST	- Special Length Versions, 90°-Corner, Midpin Spotlights/Downlights, Emergency Module, Multisensor, Cable colour Red or Black

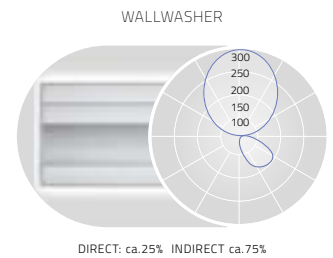
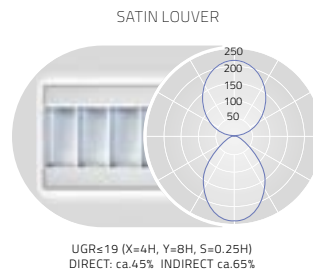
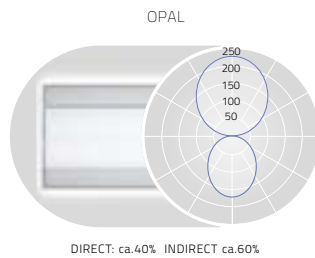
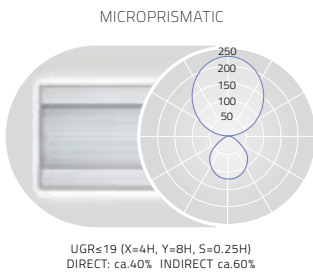

L mm	Lumen/Watt Medium Power	Lumen/Watt High Power
890	7040lm/60W	9120lm/81W
1182	9390lm/84W	12160lm/114W
1475	11740lm/102W	15200lm/138W
1765	14080lm/120W	18240lm/162W
2055	16430lm/144W	21280lm/195W

L mm	Lumen/Watt Medium Power	Lumen/Watt High Power
890	7260lm/60W	9400lm/81W
1182	9680lm/84W	12540lm/114W
1475	12100lm/102W	15670lm/138W
1765	14520lm/120W	18800lm/162W
2055	16940lm/144W	21940lm/195W

L mm	Lumen/Watt Medium Power	Lumen/Watt High Power
890	7400lm/60W	9580lm/81W
1182	9860lm/84W	12770lm/114W
1475	12330lm/102W	15960lm/138W
1765	14790lm/120W	19150lm/162W
2055	17260lm/144W	22350lm/195W

L mm	Lumen/Watt Medium Power	Lumen/Watt High Power
890	5560lm/49W	7310lm/65W
1182	7410lm/62W	9740lm/84W
1475	9270lm/75W	12170lm/102W
1765	11110lm/88W	14610lm/120W
2055	12970lm/106W	17040lm/145W

DIRECT: 100%

L mm	Lumen/Watt Medium Power	Lumen/Watt High Power
890	2820lm/33W	3650lm/44W
1182	3760lm/42W	4870lm/57W
1475	4700lm/51W	6080lm/69W
1765	5640lm/60W	7300lm/81W
2055	6580lm/75W	8520lm/101W

DIRECT: 100%

L mm	Lumen/Watt Medium Power	Lumen/Watt High Power
890	3040lm/33W	3930lm/44W
1182	4050lm/42W	5240lm/57W
1475	5060lm/51W	6560lm/69W
1765	6080lm/60W	7870lm/81W
2055	7090lm/75W	9180lm/101W

DIRECT: 100%

L mm	Lumen/Watt Medium Power	Lumen/Watt High Power
890	3170lm/33W	4110lm/44W
1182	4230lm/42W	5480lm/57W
1475	5290lm/51W	6850lm/69W
1765	6350lm/60W	8220lm/81W
2055	7400lm/75W	9590lm/101W

DIRECT: 100%

L mm	Lumen/Watt Medium Power	Lumen/Watt High Power
890	1340lm/16W	1840lm/21W
1182	1780lm/20W	2450lm/27W
1475	2230lm/24W	3060lm/33W
1765	2670lm/28W	3670lm/39W
2055	3120lm/31W	4280lm/44W

Lumen Values: Luminaire luminous flux at 4000K/CRI>80. Other configurations on request.





MIDPOINT SURFACE | B7 326



MIDPOINT SURFACE | A6 328



BASIC SUPERFLAT SURFACE | Y7/X7 334



BASIC NEO SURFACE | A5 336



BASIC AMBIENT SURFACE | A6 338



BASIC DÉCO TILTABLE SURFACE | Z3 344



BASIC MAX SURFACE | A1 346



BASIC MAX SURFACE | Y1/X1 348



BEAM ME UP JR SURFACE | Y3/X3 350



BEAM ME UP SURFACE | Y1X1 354



RINGO STAR 100MM SURFACE | A1 362



LIQUID LINE SURFACE | A3 366



THREE PEAKS SURFACE | A 370



CALEO INVERSE SURFACE | A3 372



CALEO LINEAR SURFACE | A3 374



CALEO SURFACE | Y2/X2 380



CUBIC EVOLUTION SURFACE | Y4/X4 382



CUBIC EVOLUTION SURFACE | Y5/X5 384



CUBIC EVOLUTION SURFACE | Y6/X6 386



CUBIC MAX SURFACE | A2 388



MATRIC 38MM SQUARE SURFACE | A1 394



MATRIC 38MM LENS LOUVER SURFACE | A1 402



MATRIC 38MM SURFACE | A1 404



MATRIC 55MM SURFACE | A3 406



MATRIC 81MM SURFACE | A5 408



BASIC DÉCO  
SURFACE | A3 340



BASIC DÉCO XXL  
SURFACE | A4 342



BEAM ME UP WALLWASHER  
SURFACE | A4 356



RINGO STAR 60MM  
SURFACE | A3 360



CALEO  
SURFACE | Y1/X1 376



CALEO  
SURFACE | A2 378



CUBIC MAX  
SURFACE | Y2/X2 390



CUBIC AMBIENT  
SURFACE | A7 392



MATRIC 81MM  
SURFACE | A6 410



VISION  
SURFACE | A2 412

— ANBAU | SURFACE | APPARENT

# MIDPOINT SURFACE

CAFE MÉLANIE LAMBERTZ, EUPEN, BELGIUM  
MIDPOINT-B7





JELLY BELLY ICE CREAM, BLUE WATERS, DUBAI, UAE  
MIDPOINT-B7

MIDPOINT  
SURFACE | B7



**DE** LED-Anbaustrahler für Deckenmontage. Konverter im Leuchtenkörper integriert, wahlweise einfach schaltbar oder stufenlos dimmbar (DALI). LED Engine wahlweise XICATO ARTIST für höchste Lichtqualität mit bester Farbwiedergabe und 5 Jahre Garantie für Farbkonstanz (MacAdams3) oder ECO für höchste Energieeffizienz bei optimalem Preis-Leistungsverhältnis und CRI>90. Farbtemperaturen 2700K, 3000K oder 4000K. Austauschbare Linsen-Reflektoroptiken mit sphärischer Facettenoptik. Ausstrahlwinkel: 10° (Spot), 20° (Medium), 35° (Flood) oder 50° (Wide Flood). Standardmäßig klare Abdeckung. Optional zusätzliche Filter oder Wabenraster. Gehäuse aus Aluminium in weiß, silber, schwarz oder champagnerfarben lackiert. Reflektorring zusätzlich in gold- oder kupferfarben erhältlich.

**EN** LED surface-mounted spotlight for ceilings. Driver integrated into luminaire body, optionally switchable or dimmable (DALI). LED Engine with XICATO ARTIST for highest light quality and colour rendering, including 5 year warranty for colour consistency (Mac Adams 3). Alternatively ECO for highest energy efficiency with optimal price-performance ratio and CRI> 90. Colour temperature 2700K, 3000K or 4000K. Replaceable lens reflector optics with spherical faceted optics. Beam angle: 10° (Spot), 20° (Medium), 35° (Flood) oder 50° (Wide Flood). Standard clear cover. Optional additional filters or honeycomb grid. Housing made of white, silver, black or champagne coated aluminium. Reflector ring also available in gold or copper colours.

**FR** Projecteur apparent/saillie pour montage en plafonnier. Driver intégré dans le corps du luminaire, au choix ON/OFF ou graduable (DALI). Module/COB LED XICATO ARTIST en option pour une qualité d'éclairage maximale et un rendu des couleurs exceptionnel + 5 ans de garantie sur le niveau des couleurs (MacAdams 3) ou ECO pour une efficacité énergétique et un rapport qualité-prix optimal + IRC supérieur à 90 inclus. Température de couleur 2700K, 3000K ou 4000K. Réflecteur avec optique de lentille interchangeable et facettes de réflexion sphérique. Angle d'ouverture/faisceau: 10° (Spot), 20° (Medium), 35° (Flood) oder 50° (Wide Flood). Verre de protection et de fermeture standard. Filtres divers supplémentaires et/ou filtre nid d'abeilles en option. Boîtier en aluminium couleurs blanc, argent, noir ou titane laqué.



**PRODUCT-CODE:** P B7 B S E - 9 27 F M - B K

- PRODUCT FAMILY – P: Midpoint
- TYPE – B7: Surface mounted fix
- BEAM ANGLE – A: Spot 10°, B: Medium 20°, C: Flood 35°, D: Wide Flood 50°
- SURFACE FINISH – W: Snow White, V: Ivory White, S: Radiant Silver, B: Jet Black, H: Champagne Silver
- CONTROL GEAR – E: On/Off, L: DALI
- COLOUR RENDER. – 9: CRI>90
- COLOUR TEMP. – 27: 2700K, 30: 3000K, 40: 4000K
- LED-ENGINE – F: Eco [Ra> 90], A: Artist [Ra> 97, Xicato]
- POWER – E: Low Power M: Medium Power
- OPTIC RING – W: Snow White, V: Ivory White, S: Radiant Silver, B: Jet Black, H: Champagne Silver, G: Satin Gold, K: Satin Copper
- COVER – K: Clear Cover [Standard], P: Prismatic Lens, H: Honeycomb Louver, B: Dichroic Filter [Bread], M: Dichroic Filter [Meat]



**SPOT 10° LED ENGINE ECO, MEDIUM POWER**

Mounting Height	Illuminance [Lux] center/side	Beam Diameter
1 m	25250/12700	0.24 m
2 m	6312/3175	0.48 m
3 m	2806/1411	0.72 m
4 m	1578/794	0.95 m

LED Engine	2700K	3000K	4000K
Eco Low Power [20W]	1230	1350	1440
Eco Medium Power [31W]	1660	1860	2020
Artist Low Power [21W]	1040	1090	1190
Artist Medium Power [33W]	1400	1480	1560

**MEDIUM 20° LED ENGINE ECO, MEDIUM POWER**

Mounting Height	Illuminance [Lux] center/side	Beam Diameter
1 m	17447/8455	0.32 m
2 m	4362/2114	0.64 m
3 m	1939/939	0.96 m
4 m	1090/528	1.30 m

LED Engine	2700K	3000K	4000K
Eco Low Power [20W]	1580	1740	1850
Eco Medium Power [31W]	2360	2640	2870
Artist Low Power [21W]	1330	1390	1510
Artist Medium Power [33W]	1980	2110	2220

**FLOOD 35° LED ENGINE ECO, MEDIUM POWER**

Mounting Height	Illuminance [Lux] center/side	Beam Diameter
1 m	6251/2731	0.63 m
2 m	1563/683	1.30 m
3 m	695/303	1.90 m
4 m	391/171	2.50 m

LED Engine	2700K	3000K	4000K
Eco Low Power [20W]	1530	1680	1790
Eco Medium Power [31W]	2280	2550	2780
Artist Low Power [21W]	1290	1350	1470
Artist Medium Power [33W]	1930	2060	2160

**WIDE FLOOD 50° LED ENGINE ECO, MEDIUM POWER**

Mounting Height	Illuminance [Lux] center/side	Beam Diameter
1 m	3550/1319	0.94 m
2 m	887/330	1.90 m
3 m	394/147	2.80 m
4 m	222/82	3.80 m

LED Engine	2700K	3000K	4000K
Eco Low Power [20W]	1440	1580	1680
Eco Medium Power [31W]	2230	2490	2710
Artist Low Power [21W]	1250	1310	1430
Artist Medium Power [33W]	1910	2040	2140





MIDPOINT  
SURFACE | A6



**DE** LED-Anbaustrahler für Deckenmontage. 350° drehbar und 90° schwenkbar. Konverter im Strahlerkopf integriert, einfach schaltbar. LED Engine wahlweise XICATO ARTIST für höchste Lichtqualität mit bester Farbwiedergabe und 5 Jahre Garantie für Farbkonstanz (MacAdam<sub>3</sub>) oder ECO für höchste Energieeffizienz bei optimalem Preis-Leistungsverhältnis und CRI>90. Farbtemperaturen 2700K, 3000K oder 4000K. Austauschbare Linsen-Reflektoroptiken mit sphärischer Facettenoptik. Ausstrahlwinkel: 10° (Spot), 20° (Medium), 35° (Flood) oder 50° (Wide Flood).

**EN** LED surface-mounted spotlight for ceilings. 350° rotatable and 90° tiltable. Driver integrated into spotlight head, switchable. LED Engine with XICATO ARTIST for highest light quality and colour rendering, including 5 year warranty for colour consistency (Mac Adams 3). Alternatively ECO for highest energy efficiency with optimal price-performance ratio and CRI> 90. Colour temperature 2700K, 3000K or 4000K. Replaceable lens reflector optics with spherical faceted optics. Beam angle: 10° (Spot), 20° (Medium), 35° (Flood) oder 50° (Wide Flood).

**FR** Projecteur apparent/saillie pour montage en plafonnier. Orientable à 350° et pivotant à 90°. Driver intégré dans la tête du projecteur, ON/OFF. Module/COB LED XICATO ARTIST en option pour une qualité d'éclairage maximale et un rendu des couleurs exceptionnel + 5 ans de garantie sur le niveau des couleurs (MacAdams 3) ou ECO pour une efficacité énergétique et un rapport qualité-prix optimal + IRC supérieur à 90 inclus. Température de couleur 2700K, 3000K ou 4000K. Réflecteur avec optique de lentille interchangeable et facettes de réflexion sphérique. Angle d'ouverture/faisceau: 10° (Spot), 20° (Medium), 35° (Flood) oder 50° (Wide Flood).



**PRODUCT-CODE:**

<b>PRODUCT FAMILY</b>	- P: Midpoint	<b>P</b>
<b>TYPE</b>	- A6: Surface mounted tiltable	<b>A6</b>
<b>BEAM ANGLE</b>	- A: Spot 10°, B: Medium 20°, C: Flood 35°, D: Wide Flood 50°	<b>B</b>
<b>SURFACE FINISH</b>	- W: Snow White, V: Ivory White, S: Radiant Silver, B: Jet Black, H: Champagne Silver	<b>S</b>
<b>CONTROL GEAR</b>	- E: On/Off, X: Integrated Dimmer, L: DALI	<b>E</b>
<b>COLOUR RENDER.</b>	- 9: CRI>90	<b>9</b>
<b>COLOUR TEMP.</b>	- 27: 2700K, 30: 3000K, 40: 4000K	<b>30</b>
<b>LED-ENGINE</b>	- F: Eco [Ra> 90], A: Artist [Ra> 97, Xicato]	<b>F</b>
<b>POWER</b>	- E: Low Power M: Medium Power	<b>M</b>
<b>OPTIC RING</b>	- W: Snow White, V: Ivory White, S: Radiant Silver, B: Jet Black, H: Champagne Silver, G: Satin Gold, K: Satin Copper	<b>S</b>
<b>COVER</b>	- K: Clear Cover [Standard], P: Prismatic Lens, H: Honeycomb Louver, B: Dichroic Filter [Bread], M: Dichroic Filter [Meat]	<b>K</b>



**SPOT 10° LED ENGINE ECO, MEDIUM POWER**

Mounting Height	Illuminance [Lux] center/side	Beam Diameter
1 m	25250/12700	0.24 m
2 m	6312/3175	0.48 m
3 m	2806/1411	0.72 m
4 m	1578/794	0.95 m

LED Engine	2700K	3000K	4000K
Eco Low Power [20W]	1230	1350	1440
Eco Medium Power [31W]	1660	1860	2020
Artist Low Power [21W]	1040	1090	1190
Artist Medium Power [33W]	1400	1480	1560

**MEDIUM 20° LED ENGINE ECO, MEDIUM POWER**

Mounting Height	Illuminance [Lux] center/side	Beam Diameter
1 m	17447/8455	0.32 m
2 m	4362/2114	0.64 m
3 m	1939/939	0.96 m
4 m	1090/528	1.30 m

LED Engine	2700K	3000K	4000K
Eco Low Power [20W]	1580	1740	1850
Eco Medium Power [31W]	2360	2640	2870
Artist Low Power [21W]	1330	1390	1510
Artist Medium Power [33W]	1980	2110	2220

**FLOOD 35° LED ENGINE ECO, MEDIUM POWER**

Mounting Height	Illuminance [Lux] center/side	Beam Diameter
1 m	6251/2731	0.63 m
2 m	1563/683	1.30 m
3 m	695/303	1.90 m
4 m	391/171	2.50 m

LED Engine	2700K	3000K	4000K
Eco Low Power [20W]	1530	1680	1790
Eco Medium Power [31W]	2280	2550	2780
Artist Low Power [21W]	1290	1350	1470
Artist Medium Power [33W]	1930	2060	2160

**WIDE FLOOD 50° LED ENGINE ECO, MEDIUM POWER**

Mounting Height	Illuminance [Lux] center/side	Beam Diameter
1 m	3550/1319	0.94 m
2 m	887/330	1.90 m
3 m	394/147	2.80 m
4 m	222/82	3.80 m

LED Engine	2700K	3000K	4000K
Eco Low Power [20W]	1440	1580	1680
Eco Medium Power [31W]	2230	2490	2710
Artist Low Power [21W]	1250	1310	1430
Artist Medium Power [33W]	1910	2040	2140



# BASIC SURFACE



KITA NIEDERSÄCHSISCHER LANDTAG, HANNOVER, GERMANY  
BASIC-X1

PHOTOS: FRANK AUSSIEKER



# BASIC SURFACE

PORT OF SALE, VICTORIA, AUSTRALIA  
BASIC-A1

PHOTOS: JOHN GOLLINGS PHOTOGRAPHY





BASIC SUPERFLAT  
SURFACE | Y7/X7



**DE** LED-Anbauleuchte für Wand- oder Deckenmontage. Direktstrahlend mit indirekter Lichtkorona oder rein direktstrahlend. Gestuftes Leuchtenkörper aus Aluminiumprofil mit lediglich 18mm sichtbarem Rahmenprofil. Oberfläche weiß, silber, graphit, schwarz, champagner oder kupferfarben lackiert. Weitere Oberflächenoptionen siehe Lightnet-Surface-Collection oder RAL nach Wahl. Microprismenoptik mit optimierter Blendungsbegrenzung speziell für Office-Anwendungen. Satinierter Opaldiffusor für Allgemeinbeleuchtung mit max. Transmissionsgrad und homogener Lichtpunktauflösung. Konverter in Leuchtengehäuse integriert, wahlweise einfach schaltbar oder stufenlos dimmbar (1-10V, DALI, Touch-Dim, Casambi). Farbtemperaturen 2200K, 2700K, 3000K, 3500K, 4000K oder 6500K. Binning initial  $\leq$  MacAdam 3. Farbwiedergabe CRI>80 oder CRI>90. Auf Anfrage: Integration von Notlichtkomponenten, Sensortechnologie.

**EN** LED surface-mounted luminaire for walls or ceilings. Direct light distribution and indirect lighting corona or direct only light distribution. Tiered luminaire body made of aluminium profile with only 18mm visible frame. Surface white, silver, graphite, black, champagne or copper coated. Further surface options see Lightnet-Surface-Collection or RAL of your choice. Microprismatic with optimized glare reduction especially for workplaces. Satin opal diffuser for general lighting with maximum transmittance and homogeneous lighting. Converter integrated into luminaire housing, optionally switchable or dimmable (1-10V, DALI, Touch-Dim, Casambi). Colour temperatures 2200K, 2700K, 3000K, 3500K, 4000K or 6500K. Binning initial  $\leq$  MacAdam 3. Colour rendering CRI>80 or CRI>90. On request: Integration of emergency lighting components, sensor technology.

**FR** Luminaire LED en saillie pour murs et plafonds. Éclairage direct avec colerette de lumière indirecte ou uniquement éclairage direct. Corps du luminaire étagé en profilé aluminium avec cadre visible de seulement 18mm. Surface laquée blanc, argent, graphite, noir, champagne ou cuivre. Autres options de finition voir Lightnet-Surface-Collection ou RAL au choix. Diffuseur microprismatique optimisé pour un éblouissement limité et adapté aux bureaux. Diffuseur opale satiné pour un éclairage général et une transmission maximale et homogène. Driver intégré dans le luminaire, au choix ON/OFF ou graduable (1-10V, DALI, Touch-Dim, Casambi). Température de couleur 2200K, 2700K, 3000K, 3500K, 4000K ou 6500K. Binning initial  $\leq$  MacAdam 3. Rendu de couleur CRI>80 ou CRI>90. Sur demande: Intégration de composants d'éclairage de secours ou de capteurs.

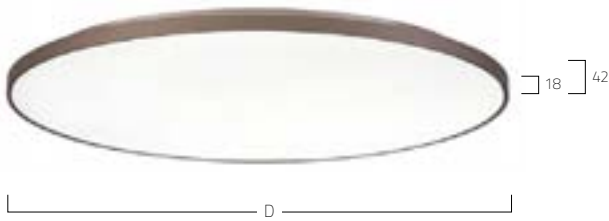

**PRODUCT-CODE: B X7 A S D - 8 30 M - D300**

- PRODUCT FAMILY - **B**: Basic
- TYPE - **X7**: Direct-Indirect, **Y7**: Direct Only
- OPTICAL SYSTEM - **A**: Microprismatic, **O**: Opal
- SURFACE FINISH - **W**: Snow White, **V**: Ivory White, **S**: Radiant Silver, **U**: Urban Graphite, **B**: Jet Black, **H**: Champagne Silver, **K**: Satin Copper
- CONTROL GEAR - **E**: On/Off, **L**: DALI, **D**: 1-10V, **H**: Touch-Dim, **C**: Casambi
- COLOUR REND. - **8**: CRI>80, **9**: CRI>90
- COLOUR TEMP. - **22**: 2200K, **27**: 2700K, **30**: 3000K, **35**: 3500K, **40**: 4000K, **65**: 6500K **TW**: Tunable White 2700-6500K [D400-D800]
- POWER - **M**: Medium Power, **H**: High Power
- SIZE - Luminaire Diameter in mm: **D300, D400, D500, D600, D800**
- ON REQUEST - Multisensor, Radar Sensor, Emergency Module



MICROPRISMATIC / DIRECT-INDIRECT

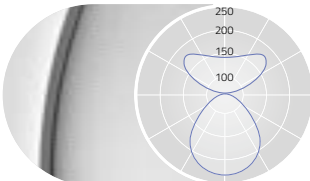

UGR $\leq 19$  (X=4H, Y=8H, S=0.25H)  
DIRECT: ca.50% INDIRECT ca.50%

D mm	Lumen/Watt Medium Power	Lumen/Watt High Power
300	1470lm/11W	2490lm/19W
400	3160lm/23W	5060lm/37W
500	4170lm/29W	6890lm/49W
600	6040lm/41W	9640lm/68W
800	11310lm/78W	14940lm/110W

MICROPRISMATIC / DIRECT

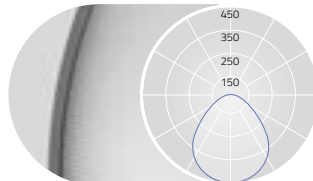

UGR $\leq 19$  for Medium Power (X=4H, Y=8H, S=0.25H)  
DIRECT: 100%

D mm	Lumen/Watt Medium Power	Lumen/Watt High Power
300	770lm/7W	1320lm/11W
400	1630lm/12W	2670lm/19W
500	2370lm/16W	3970lm/28W
600	3770lm/25W	6130lm/42W
800	5900lm/40W	7920lm/54W

OPAL DIFFUSER / DIRECT-INDIRECT

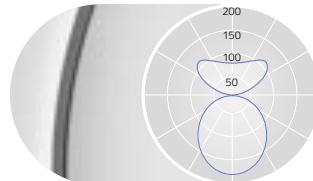

DIRECT: ca.50% INDIRECT ca.50%

D mm	Lumen/Watt Medium Power	Lumen/Watt High Power
300	1480lm/11W	2500lm/19W
400	3180lm/23W	5090lm/37W
500	4210lm/29W	6950lm/49W
600	6110lm/41W	9750lm/68W
800	11450lm/78W	15120lm/110W

OPAL DIFFUSER / DIRECT

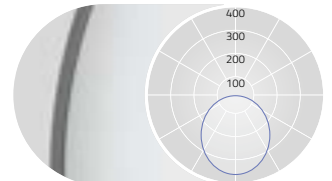

DIRECT: 100%

D mm	Lumen/Watt Medium Power	Lumen/Watt High Power
300	780lm/7W	1330lm/11W
400	1650lm/12W	2700lm/19W
500	2410lm/16W	4030lm/28W
600	3840lm/25W	6240lm/42W
800	6040lm/40W	8100lm/54W

Lumen Values: Luminaire luminous flux at 4000K/CRI>80. Other configurations on request.



MULTISENSOR CONTROL

EMERGENCY MODULE



SNOW WHITE

RADIANT SILVER

URBAN GRAPHITE

JET BLACK

CHAMPAGNE SILVER

SATIN COPPER



BASIC NEO  
SURFACE | A5



**DE** LED-Anbauleuchte für Wand- oder Deckenmontage. Rein direktstrahlend. Leuchtenkörper aus Aluminiumprofil mit filigraner Bauhöhe von 38mm ohne zusätzliche Distanzelemente. Oberfläche weiß, silber, graphit, schwarz, champagner oder kupferfarben lackiert. Weitere Oberflächenoptionen siehe Lightnet-Surface-Collection oder RAL nach Wahl. Microprismenoptik mit optimierter Blendungsbegrenzung speziell für Office-Anwendungen. Satinierter Opaldiffusor für Allgemeinbeleuchtung mit max. Transmissionsgrad und homogener Lichtpunktauflösung. Konverter in Leuchtengehäuse integriert, wahlweise einfach schaltbar oder stufenlos dimmbar (1-10V, DALI, Touch-Dim). Farbtemperaturen 2200K, 2700K, 3000K, 3500K, 4000K oder 6500K. Binning initial  $\leq$  MacAdam 3. Farbwiedergabe CRI>80 oder CRI>90. Auf Anfrage: Integration von Notlichtkomponenten, Sensortechnologie, Casambi.

**EN** LED surface-mounted luminaire for walls or ceilings. Direct only light distribution. Luminaire body made of aluminium profile with filigree overall height of 38mm without additional spacers. Surface white, silver, graphite, black, champagne or copper coated. Further surface options see Lightnet-Surface-Collection or RAL of your choice. Microprismatic with optimized glare reduction especially for workplaces. Satin opal diffuser for general lighting with maximum transmittance and homogeneous lighting. Driver integrated into luminaire housing, optionally switchable or dimmable (1-10V, DALI, Touch-Dim). Colour temperatures 2200K, 2700K, 3000K, 3500K, 4000K or 6500K. Binning initial  $\leq$  MacAdam 3. Colour rendering CRI>80 or CRI>90. On request: Integration of emergency lighting components, sensor technology, Casambi.

**FR** Luminaire LED en saillie pour murs et plafonds. Éclairage seulement direct. Corps du luminaire en profilé aluminium avec une épaisseur fine de 38mm sans espacements/entretoises supplémentaires. Surface laquée blanc, argent, graphite, noir, champagne ou cuivre. Autres options de finition voir Lightnet-Surface-Collection ou RAL au choix. Diffuseur microprismatique optimisé pour un éblouissement limité et adapté aux bureaux. Diffuseur opale satiné pour un éclairage général et une transmission maximale et homogène. Driver intégré dans le luminaire, au choix ON/OFF ou graduable (1-10V, DALI, Touch-Dim). Température de couleur 2200K, 2700K, 3000K, 3500K, 4000K ou 6500K. Binning initial  $\leq$  MacAdam 3. Rendu de couleur CRI>80 ou CRI>90. Sur demande: Intégration de composants d'éclairage de secours ou de capteurs, Casambi.



**PRODUCT-CODE:** B A5 O S D - 8 30 M - D400

- PRODUCT FAMILY - **B**: Basic
- TYPE - **A5**: Direct Only
- OPTICAL SYSTEM - **A**: Microprismatic, **O**: Opal
- SURFACE FINISH - **W**: Snow White, **V**: Ivory White, **S**: Radiant Silver, **U**: Urban Graphite, **B**: Jet Black, **H**: Champagne Silver, **K**: Satin Copper
- CONTROL GEAR - **E**: On/Off, **L**: DALI, **D**: 1-10V, **H**: Touch-Dim
- COLOUR REND. - **8**: CRI>80, **9**: CRI>90, **F**: Full Spectrum
- COLOUR TEMP. - **22**: 2200K, **27**: 2700K, **30**: 3000K, **35**: 3500K, **40**: 4000K, **65**: 6500K, **TW**: Tunable White 2700-6500K [D300-D800]
- POWER - **M**: Medium Power, **H**: High Power
- SIZE - Luminaire Diameter in mm: **D200**, **D300**, **D400**, **D500**, **D600**, **D800**
- ON REQUEST - Multisensor, Radar Sensor, Emergency Module, Casambi



MICROPRISMATIC / DIRECT

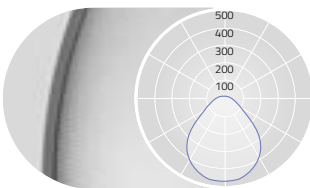

UGRs19 for Medium Power (X=4H, Y=8H, S=0.25H)  
DIRECT: 100%

OPAL DIFFUSER / DIRECT

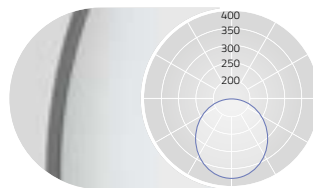

DIRECT: 100%

D mm	Lumen/Watt Medium Power	Lumen/Watt High Power
200	320lm/4W	550lm/6W
300	770lm/7W	1320lm/11W
400	1630lm/12W	2670lm/19W
500	2370lm/16W	3970lm/28W
600	3770lm/25W	6130lm/42W
800	5900lm/40W	7920lm/54W

D mm	Lumen/Watt Medium Power	Lumen/Watt High Power
200	330lm/4W	560lm/6W
300	780lm/7W	1330lm/11W
400	1650lm/12W	2700lm/19W
500	2410lm/16W	4030lm/28W
600	3840lm/25W	6240lm/42W
800	6040lm/40W	8100lm/54W

Lumen Values: Luminaire luminous flux at 4000K/CRI>80. Other configurations on request.



MULTISENSOR CONTROL

EMERGENCY MODULE



SNOW WHITE

RADIANT SILVER

URBAN GRAPHITE

JET BLACK

CHAMPAGNE SILVER

SATIN COPPER

BASIC AMBIENT  
SURFACE | A6



**DE** LED-Anbauleuchte für Wand- oder Deckenmontage. Direkt-rundumstrahlend für dezente Deckenaufhellung. Leuchtenkörper aus Aluminiumprofil und Diffusor mit 60mm Bauhöhe. Ambientdiffusor aus satiniertem Acrylglas für Allgemeinbeleuchtung. Oberfläche weiß, silber, graphit, schwarz, champagner oder kupferfarben lackiert. Weitere Oberflächenoptionen siehe Lightnet-Surface-Collection oder RAL nach Wahl. Konverter in Leuchtgehäuse integriert, wahlweise einfach schaltbar oder stufenlos dimmbar (1-10V, DALI, Touch-Dim, Casambi). Farbtemperaturen 2200K, 2700K, 3000K, 3500K, 4000K oder 6500K. Binning initial  $\leq$  MacAdam 3. Farbwiedergabe CRI>80 oder CRI>90. Auf Anfrage: Integration von Notlichtkomponenten, Sensortechnologie.

**EN** LED surface-mounted luminaire for walls or ceilings. Omnidirectional light distribution for discreet illumination of the ceiling. Luminaire body made of aluminium profile and diffuser with overall height of 60mm. Ambient diffuser made of frosted acrylic glass for general lighting. Surface white, silver, graphite, black, champagne or copper coated. Further surface options see Lightnet-Surface-Collection or RAL of your choice. Converter integrated into luminaire housing, optionally switchable or dimmable (1-10V, DALI, Touch-Dim, Casambi). Colour temperatures 2200K, 2700K, 3000K, 3500K, 4000K or 6500K. Binning initial  $\leq$  MacAdam 3. Colour rendering CRI>80 or CRI>90. On request: Integration of emergency lighting components, sensor technology.

**FR** Luminaire LED en saillie pour murs et plafonds. Cadre de montage périphérique avec une hauteur totale visible de seulement 18 mm. Corps du luminaire en profilé aluminium avec diffuseur de 60mm de hauteur. Diffuseur AMBIENT en verre satiné acrylique pour diverses applications d'éclairage. Surface laquée blanc, argent, graphite, noir, champagne ou cuivre. Autres options de finition voir Lightnet-Surface-Collection ou RAL au choix. Driver intégré dans le luminaire, au choix ON/OFF ou graduable (1-10V, DALI, Touch-Dim, Casambi). Température de couleur 2200K, 2700K, 3000K, 3500K, 4000K ou 6500K. Binning initial  $\leq$  MacAdam 3. Rendu de couleur CRI>80 ou CRI>90. Sur demande: Intégration de composants d'éclairage de secours ou de capteurs.



**PRODUCT-CODE:** B A6 F S D - 8 30 M - D300

- PRODUCT FAMILY – B: Basic
- TYPE – A6: Direct Only
- OPTICAL SYSTEM – F: Ambient
- SURFACE FINISH – W: Snow White, V: Ivory White, S: Radiant Silver, U: Urban Graphite, B: Jet Black, H: Champagne Silver, K: Satin Copper
- CONTROL GEAR – E: On/Off, L: DALI, D: 1-10V, H: Touch-Dim, C: Casambi
- COLOUR REND. – 8: CRI>80, 9: CRI>90, F: Full Spectrum
- COLOUR TEMP. – 22: 2200K, 27: 2700K, 30: 3000K, 35: 3500K, 40: 4000K, 65: 6500K, TW: Tunable White 2700-6500K [D500-D600]
- POWER – M: Medium Power, H: High Power
- SIZE – Luminaire Diameter in mm: D300, D400, D500, D600
- ON REQUEST – Radar Sensor, Emergency Module



AMBIENT DIFFUSER / DIRECT

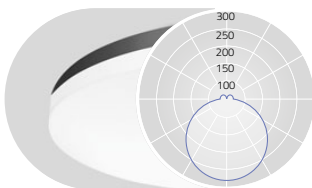

DIRECT: ca.98% INDIRECT: ca.2%

D mm	Lumen/Watt Medium Power	Lumen/Watt High Power
300	920lm/8W	1810lm/16W
400	1830lm/13W	3760lm/26W
500	2600lm/18W	5150lm/36W
600	4080lm/28W	7600lm/53W

Lumen Values: Luminaire luminous flux at 4000K/CRI>80. Other configurations on request.



BASIC DÉCO  
SURFACE | A3



**DE** LED-Anbauleuchte für Wand- und Deckenmontage. Rein direktstrahlend. Leuchtenkörper aus Aluminiumprofil mit Bauhöhe 58mm in. Gehäuse-Außenfläche und dekorativer Reflektorring in unterschiedlichen Lackierungen und Kombinationen erhältlich, z.B. weiß, silber, graphit, schwarz, gold oder kupferfarben. Zu Oberflächenoptionen- und Kombinationen siehe Lightnet-Surface-Collection oder Bi-Colour-Auswahl. Rückversetzte Microprismenoptik mit optimierter Blendungsbegrenzung speziell für Office-Anwendungen. Satinierter Opaldiffusor für Allgemeinbeleuchtung mit max. Transmissionsgrad und homogener Lichtpunkt-auflösung. Konverter in Leuchtgehäuse integriert, wahlweise einfach schaltbar oder stufenlos dimmbar (1-10V, DALI, Touch-Dim, Casambi). Farbtemperaturen 2200K, 2700K, 3000K, 3500K, 4000K oder 6500K. Binning initial  $\leq$  MacAdam 3. Farbwiedergabe CRI>80 oder CRI>90.

**EN** LED surface-mounted luminaire for walls and ceilings. Direct only light distribution. Luminaire body made of aluminium profile with overall height of 58mm. Outer housing and decorative reflector ring available in various finishes and combinations, e.g. white, silver, graphite, black, gold or copper coated. For surface options and combinations check Lightnet Surface Collection or Bi-Colour Selection. Recessed Microprismatic with optimized glare reduction especially for workplaces. Satin opal diffuser for general lighting with maximum transmittance and homogeneous lighting. Driver integrated into luminaire housing, optionally switchable or dimmable (1-10V, DALI, Touch-Dim, Casambi). Colour temperatures 2200K, 2700K, 3000K, 3500K, 4000K or 6500K. Binning initial  $\leq$  MacAdam 3. Colour rendering CRI>80 or CRI>90.

**FR** Luminaire LED en saillie pour murs et plafonds. Éclairage seulement direct. Corps du luminaire en profilé aluminium avec une hauteur de 58mm. Surface du luminaire et réflecteur/bague décorative disponible en différentes combinaisons et couleurs au choix, Ex: blanc, argent, graphite, noir ou cuivre. Pour les options et combinaisons de finitions, voir Lightnet Surface Collection ou Bi-Colour Selection. Diffuseur microprismatique encastré avec réduction optimisée de l'éblouissement, spécialement pour les postes de travail. Diffuseur opale satiné pour un éclairage général et une transmission maximale et homogène. Driver intégré dans le luminaire, au choix ON/OFF ou graduable (1-10V, DALI, Touch-Dim, Casambi). Température de couleur 2200K, 2700K, 3000K, 3500K, 4000K ou 6500K. Binning initial  $\leq$  Mac Adam 3. Rendu de couleur CRI>80 ou CRI>90.



**PRODUCT-CODE:** B A3 O S D - 8 30 M - D400 - S

- PRODUCT FAMILY - **B**: Basic
- TYPE - **A3**: Direct Only
- OPTICAL SYSTEM - **A**: Microprismatic, **O**: Opal
- SURFACE FINISH - **W**: Snow White, **V**: Ivory White, **S**: Radiant Silver, **U**: Urban Graphite, **B**: Jet Black, **H**: Champagne Silver, **K**: Satin Copper
- CONTROL GEAR - **E**: On/Off, **L**: DALI, **D**: 1-10V, **H**: Touch-Dim
- COLOUR REND. - **8**: CRI>80, **9**: CRI>90, **F**: Full Spectrum
- COLOUR TEMP. - **22**: 2200K, **27**: 2700K, **30**: 3000K, **35**: 3500K, **40**: 4000K, **65**: 6500K, **TW**: Tunable White 2700-6500K [D300-D800]
- POWER - **M**: Medium Power, **H**: High Power
- SIZE - Luminaire Diameter in mm: **D200** **D300** **D400** **D500** **D600** **D800**
- REFLECTOR - **W**: Snow White, **V**: Ivory White, **S**: Radiant Silver, **U**: Urban Graphite, **B**: Jet Black, **H**: Champagne Silver, **K**: Satin Copper, **G**: Satin Gold
- ON REQUEST - Multisensor, Radar Sensor, Emergency Module, Casambi

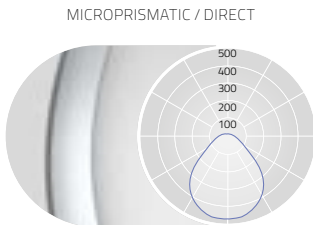

UGR<sub>s19</sub> for Medium Power (X=4H, Y=8H, S=0.25H)  
DIRECT: 100%

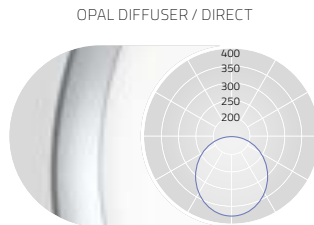

DIRECT: 100%

D mm	Lumen/Watt Medium Power	Lumen/Watt High Power
200	300lm/4W	600lm/6W
300	920lm/8W	1590lm/13W
400	1750lm/14W	2760lm/21W
500	2730lm/22W	4510lm/36W
600	3950lm/28W	5810lm/42W
800	5960lm/43W	7360lm/54W

D mm	Lumen/Watt Medium Power	Lumen/Watt High Power
200	270lm/4W	550lm/6W
300	900lm/8W	1560lm/13W
400	1750lm/14W	2760lm/21W
500	2750lm/22W	4570lm/36W
600	4050lm/28W	5920lm/42W
800	6120lm/43W	7560lm/54W

Lumen Values: Luminaire luminous flux at 4000K/CRI>80. Other configurations on request.



MULTISENSOR CONTROL

EMERGENCY MODULE



BASIC DÉCO XXL  
SURFACE | A4



**DE** LED-Anbauleuchte für Wand- und Deckenmontage. Rein direktstrahlend. Leuchtenkörper aus Aluminiumprofil mit Bauhöhe 100mm. Gehäuse-Außenfläche und dekorativer Reflektorring in unterschiedlichen Lackierungen und Kombinationen erhältlich, z.B. weiß, silber, graphit, schwarz, gold oder kupferfarben. Zu Oberfläche- und Kombinationen siehe Lightnet-Surface-Collection oder Bi-Colour-Auswahl. Rückversetzte Microprismenoptik mit optimierter Blendungsbegrenzung speziell für Office-Anwendungen. Satinierter Opaldiffusor für Allgemeinbeleuchtung mit max. Transmissionsgrad und homogener Lichtpunktauflösung. Converter in Leuchtgehäuse integriert, wahlweise einfach schaltbar oder stufenlos dimmbar (1-10V, DALI, Touch-Dim, Casambi). Farbtemperaturen 2200K, 2700K, 3000K, 3500K, 4000K oder 6500K. Binning initial  $\leq$  MacAdam 3. Farbwiedergabe CRI>80 oder CRI>90. Auf Anfrage: Integration von Notlichtkomponenten.

**EN** LED surface-mounted luminaire for walls and ceilings. Direct only light distribution. Luminaire body made of aluminium profile with overall height of 100mm. Outer housing and decorative reflector ring available in various finishes and combinations, e.g. white, silver, graphite, black, gold or copper coated. For surface options and combinations check Lightnet Surface Collection or Bi-Colour Selection. Recessed Microprismatic with optimized glare reduction especially for workplaces. Satin opal diffuser for general lighting with maximum transmittance and homogeneous lighting. Converter integrated into luminaire housing, optionally switchable or dimmable (1-10V, DALI, Touch-Dim, Casambi). Colour temperatures 2200K, 2700K, 3000K, 3500K, 4000K or 6500K. Binning initial  $\leq$  MacAdam 3. Colour rendering CRI>80 or CRI>90. On request: Integration of emergency lighting components.

**FR** Luminaire LED en saillie pour murs et plafonds. Éclairage seulement direct. Corps du luminaire en profilé aluminium avec une hauteur de 100mm. Surface du luminaire et réflecteur/bague décorative disponible en différentes combinaisons et couleurs au choix, Ex: blanc, argent, graphite, noir ou cuivre. Pour les options et combinaisons de finitions, voir Lightnet Surface Collection ou Bi-Colour Selection. Diffuseur microprismatique encastré avec réduction optimisée de l'éblouissement, spécialement pour les postes de travail. Diffuseur opale satiné pour un éclairage général et une transmission maximale et homogène. Driver intégré dans le luminaire, au choix ON/OFF ou graduable (1-10V, DALI, Touch-Dim, Casambi). Température de couleur 2200K, 2700K, 3000K, 3500K, 4000K ou 6500K. Binning initial  $\leq$  MacAdam 3. Rendu de couleur CRI>80 ou CRI>90. Sur demande: Intégration de composants d'éclairage de secours

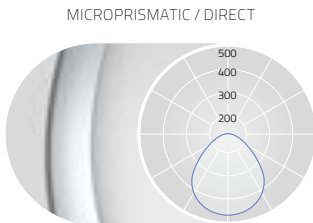
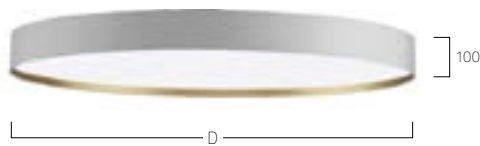

UGRs19 for Low Power (X=4H, Y=8H, S=0.25H)  
DIRECT: 100%

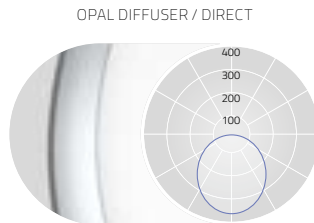

DIRECT: 100%

D mm	Lumen/Watt Low Power	Lumen/Watt Medium Power
300	880lm/8W	1730lm/14W
400	1740lm/13W	3580lm/29W
500	2480lm/18W	4860lm/35W
600	3860lm/28W	7250lm/52W
900	6800lm/59W	11490lm/106W
1200	11890lm/107W	20110lm/195W

D mm	Lumen/Watt Low Power	Lumen/Watt Medium Power
300	910lm/8W	1780lm/14W
400	1790lm/13W	3690lm/29W
500	2550lm/18W	5010lm/35W
600	3980lm/28W	7470lm/52W
900	7000lm/59W	11830lm/106W
1200	12250lm/107W	20700lm/195W

Lumen Values: Luminaire luminous flux at 4000K/CRI>80. Other configurations on request.

**PRODUCT-CODE: B A4 A S D - 8 30 M - D300 - G**

- PRODUCT FAMILY – **B** Basic
- TYPE – **A4** Direct Only
- OPTICAL SYSTEM – **A** Microprismatic, **O** Opal
- SURFACE FINISH – **W** Snow White, **V** Ivory White, **S** Radiant Silver, **U** Urban Graphite, **B** Jet Black, **H** Champagne Silver, **K** Satin Copper
- CONTROL GEAR – **E** On/Off, **L** DALI, **D** 1-10V, **H** Touch-Dim, **C** Casambi
- COLOUR REND. – **8** CRI>80, **9** CRI>90, **F** Full Spectrum
- COLOUR TEMP. – **22** 2200K, **27** 2700K, **30** 3000K, **35** 3500K, **40** 4000K, **65** 6500K, **TW** Tunable White 2700-6500K
- POWER – **E** Low Power, **M** Medium Power
- SIZE – Luminaire Diameter in mm: **D300**, **D400**, **D500**, **D600**, **D900**, **D1200**
- REFLECTOR – **W** Snow White, **V** Ivory White, **S** Radiant Silver, **U** Urban Graphite, **B** Jet Black, **H** Champagne Silver, **K** Satin Copper, **G** Satin Gold
- ON REQUEST – Radar Sensor, Emergency Module





# BASIC DÉCO TILTABLE SURFACE | Z3



**DE** LED-Anbaustrahler für Wand- oder Deckenmontage. 350° drehbar und 90° schwenkbar. Rein direktstrahlend. Leuchtenkörper aus Aluminiumprofil mit Bauhöhe 58mm. Gehäuse-Außenfläche und dekorativer Reflektorring in unterschiedlichen Lackierungen und Kombinationen erhältlich, z.B. weiß, silber, graphit, schwarz, gold oder kupferfarben. Zu Oberflächenoptionen- und Kombinationen siehe Lightnet-Surface-Collection oder Bi-Colour-Auswahl. Rückversetzte Microprismenoptik mit optimierter Blendungsbegrenzung speziell für Office-Anwendungen. Satinierter Opaldiffusor für Allgemeinbeleuchtung mit max. Transmissionsgrad und homogener Lichtpunktauflösung. Konverter in Leuchtengehäuse integriert, wahlweise einfach schaltbar oder stufenlos dimmbar (1-10V, DALI, Touch-Dim, Casambi). Farbtemperaturen 2200K, 2700K, 3000K, 3500K, 4000K oder 6500K. Binning initial  $\leq$  MacAdam 3. Farbwiedergabe CRI>80 oder CRI>90. Durchdachtes Montagesystem für einfache Installation und stabilen Halt.

**EN** LED surface-mounted spotlight for walls or ceilings. 350° rotatable and 90° tiltable. Direct only light distribution. Luminaire body made of aluminium profile with overall height of 58mm. Outer housing and decorative reflector ring available in various finishes and combinations, e.g. white, silver, graphite, black, gold or copper coated. For surface options and combinations check Lightnet Surface Collection or Bi-Colour Selection. Recessed Microprismatic with optimized glare reduction especially for workplaces. Satin opal diffuser for general lighting with maximum transmittance and homogeneous lighting. Converter integrated into luminaire housing, optionally switchable or dimmable (1-10V, DALI, Touch-Dim, Casambi). Colour temperatures 2200K, 2700K, 3000K, 3500K, 4000K or 6500K. Binning initial  $\leq$  MacAdam 3. Colour rendering CRI>80 or CRI>90. Sophisticated mounting system for easy installation and stable hold.

**FR** Spot LED en saillie pour murs et plafonds. Orientable à 350° et pivotant à 90°. Éclairage seulement direct. Corps du luminaire en profilé aluminium avec une hauteur de 58mm. Surface du luminaire et réflecteur /bague décorative disponible en différentes combinaisons et couleurs au choix, Ex: blanc, argent, graphite, noir ou cuivre. Pour les options et combinaisons de finitions, voir Lightnet Surface Collection ou Bi-Colour Selection. Diffuseur microprismatique encastré avec réduction optimisée de l'éblouissement, spécialement pour les postes de travail. Diffuseur opale satiné pour un éclairage général et une transmission maximale et homogène. Driver intégré dans le luminaire, au choix ON/OFF ou graduable (1-10V, DALI, Touch-Dim, Casambi). Température de couleur 2200K, 2700K, 3000K, 3500K, 4000K ou 6500K. Binning initial  $\leq$  MacAdam 3. Rendu de couleur CRI>80 ou CRI>90. Système de montage sophistiqué pour une installation facile et stable.



**PRODUCT-CODE: B Z3 O S D - 8 30 M - D300 - S**

PRODUCT FAMILY	- B: Basic
TYPE	- Z3: Surface mounted Direct Only, tiltable
OPTICAL SYSTEM	- A: Microprismatic, O: Opal
SURFACE FINISH	- W: Snow White, V: Ivory White, S: Radiant Silver, U: Urban Graphite, B: Jet Black, H: Champagne Silver, K: Satin Copper
CONTROL GEAR	- E: On/Off, L: DALI, D: 1-10V, H: Touch-Dim, C: Casambi
COLOUR REND.	- 8: CRI>80, 9: CRI>90, F: Full Spectrum
COLOUR TEMP.	- 22: 2200K, 27: 2700K, 30: 3000K, 35: 3500K, 40: 4000K, 65: 6500K
POWER	- M: Medium Power, H: High Power
SIZE	- Luminaire Diameter in mm: D300
REFLECTOR	- W: Snow White, V: Ivory White, S: Radiant Silver, U: Urban Graphite, B: Jet Black, H: Champagne Silver, K: Satin Copper, G: Satin Gold

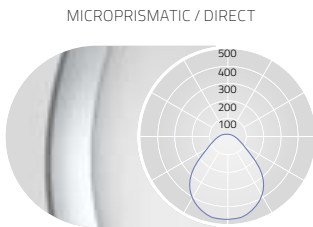

UGR $\leq$ 19 for Medium Power (X=4H, Y=8H, S=0.25H)  
DIRECT: 100%

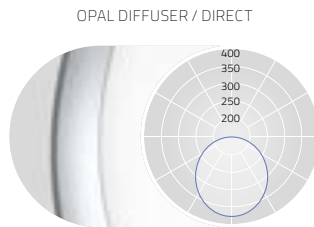

DIRECT: 100%

D mm	Lumen/Watt Medium Power	Lumen/Watt High Power
300	920lm/8W	1590lm/13W

D mm	Lumen/Watt Medium Power	Lumen/Watt High Power
300	900lm/8W	1560lm/13W

Lumen Values: Luminaire luminous flux at 4000K/CRI>80. Other configurations on request.



BASIC MAX  
SURFACE | A1



**DE** LED-Anbauleuchte für Wand- oder Deckenmontage. Rein direktstrahlend. Leuchtenkörper aus Aluminiumprofil. 6 verschiedene Durchmesser von 300 bis 1200mm. Oberfläche weiß, silber, graphit, schwarz, champagner oder kupferfarben lackiert. Weitere Oberflächenoptionen siehe Lightnet-Surface-Collection oder RAL nach Wahl. Microprismenoptik mit optimierter Blendungsbegrenzung speziell für Office-Anwendungen. Satiniertes Opaldiffusor für Allgemeinbeleuchtung mit max. Transmissionsgrad und homogener Lichtpunktauflösung. Konverter in Leuchtengehäuse integriert, wahlweise einfach schaltbar oder stufenlos dimmbar (1-10V, DALI, Touch-Dim, Casambi). Farbtemperaturen 2200K, 2700K, 3000K, 3500K, 4000K oder 6500K. Binning initial  $\leq$  MacAdam 3. Farbwiedergabe CRI>80 oder CRI>90. Auf Anfrage: Integration von Notlichtkomponenten, Sensortechnologie.

**EN** LED surface-mounted luminaire for walls or ceilings. Direct only light distribution. Luminaire body made of aluminum profile. 6 different diameters from 300mm to 1200mm. Surface white, silver, graphite, black, champagne or copper coated. Further surface options see Lightnet-Surface-Collection or RAL of your choice. Microprismatic with optimized glare reduction especially for workplaces. Satin opal diffuser for general lighting with maximum transmittance and homogeneous lighting. Converter integrated into luminaire housing, optionally switchable or dimmable (1-10V, DALI, Touch-Dim, Casambi). Colour temperatures 2200K, 2700K, 3000K, 3500K, 4000K or 6500K. Binning initial  $\leq$  MacAdam 3. Colour rendering CRI>80 or CRI>90. On request: Integration of emergency lighting components, sensor technology.

**FR** Luminaire LED en saillie pour murs et plafonds. Éclairage seulement direct. Corps du luminaire en profilé aluminium. 6 diamètres différents de 300mm à 1200mm. Surface laquée blanc, argent, graphite, noir, champagne ou cuivre. Autres options de finition voir Lightnet-Surface-Collection ou RAL au choix. Diffuseur microprismatique optimisé pour un éblouissement limité et adapté aux bureaux. Diffuseur opale satiné pour un éclairage général et une transmission maximale et homogène. Driver intégré dans le luminaire, au choix ON/OFF ou graduable (1-10V, DALI, Touch-Dim, Casambi). Température de couleur 2200K, 2700K, 3000K, 3500K, 4000K ou 6500K. Binning initial  $\leq$  MacAdam 3. Rendu de couleur CRI>80 ou CRI>90. Sur demande: Intégration de composants d'éclairage de secours ou de capteurs.

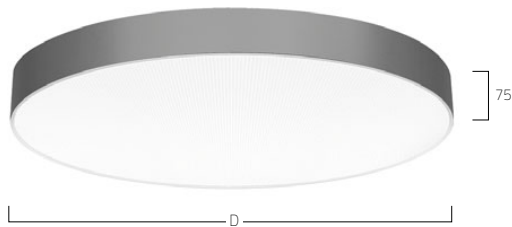

**PRODUCT-CODE: B A1 O S D - 8 30 M - D300**

- PRODUCT FAMILY - **B**: Basic
- TYPE - **A1**: Direct Only
- OPTICAL SYSTEM - **A**: Microprismatic, **O**: Opal,
- SURFACE FINISH - **W**: Snow White, **V**: Ivory White, **S**: Radiant Silver,  
**U**: Urban Graphite, **B**: Jet Black,  
**H**: Champagne Silver, **K**: Satin Copper
- CONTROL GEAR - **E**: On/Off, **L**: DALI, **D**: 1-10V, **H**: Touch-Dim, **C**: Casambi
- COLOUR REND. - **8**: CRI>80, **9**: CRI>90, **F**: Full Spectrum
- COLOUR TEMP. - **22**: 2200K, **27**: 2700K, **30**: 3000K, **35**: 3500K, **40**: 4000K,  
**65**: 6500K, **TW**: Tunable White 2700-6500K
- POWER - **E**: Low Power, **M**: Medium Power
- SIZE - Luminaire Diameter in mm: **D200**, **D300**, **D400**, **D500**, **D600**, **D900**, **D1200**
- ON REQUEST - Radar Sensor, Emergency Module

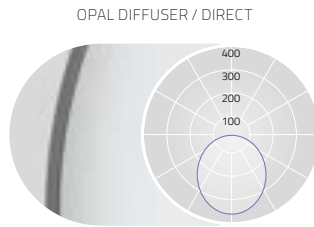
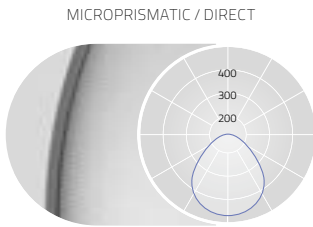

D mm	Lumen/Watt Low Power	Lumen/Watt Medium Power
200	450lm/5W	1110lm/10W
300	880lm/8W	1730lm/14W
400	1740lm/13W	3580lm/29W
500	2480lm/18W	4860lm/35W
600	3860lm/28W	7250lm/52W
900	6800lm/59W	11490lm/106W
1200	11890lm/107W	20110lm/195W

D mm	Lumen/Watt Low Power	Lumen/Watt Medium Power
200	470lm/5W	1160lm/10W
300	910lm/8W	1780lm/14W
400	1790lm/13W	3690lm/29W
500	2550lm/18W	5010lm/35W
600	3980lm/28W	7470lm/52W
900	7000lm/59W	11830lm/106W
1200	12250lm/107W	20700lm/195W

Lumen Values: Luminaire luminous flux at 4000K/CRI>80. Other configurations on request.



BASIC MAX  
SURFACE | Y1/X1



**DE** LED-Anbauleuchte für Wand- oder Deckenmontage. Direktstrahlend mit indirekter Lichtkorona oder rein direktstrahlend. 6 verschiedene Durchmesser von 300 bis 1200mm. Oberfläche weiß, silber, graphit, schwarz, champagner oder kupferfarben lackiert. Weitere Oberflächenoptionen siehe Lightnet-Surface-Collection oder RAL nach Wahl. Microprismenoptik mit optimierter Blendungsbegrenzung speziell für Office-Anwendungen. Satinierter Opaldiffusor für Allgemeinbeleuchtung mit max. Transmissionsgrad und homogener Lichtpunktauflösung. Konverter in Leuchtgehäuse integriert, wahlweise einfach schaltbar oder stufenlos dimmbar (1-10V, DALI, Touch-Dim, Casambi). Farbtemperaturen 2200K, 2700K, 3000K, 3500K, 4000K oder 6500K. Binning initial  $\leq$  MacAdam 3. Farbwiedergabe CRI>80 oder CRI>90. Auf Anfrage: Integration von Notlichtkomponenten, Sensortechnologie.

**EN** LED surface-mounted luminaire for walls or ceilings. Direct light distribution and indirect lighting corona or direct only light distribution. 6 different diameters from 300mm to 1200mm. Surface white, silver, graphite, black, champagne or copper coated. Further surface options see Lightnet-Surface-Collection or RAL of your choice. Microprismatic with optimized glare reduction especially for workplaces. Satin opal diffuser for general lighting with maximum transmittance and homogeneous lighting. Converter integrated into luminaire housing, optionally switchable or dimmable (1-10V, DALI, Touch-Dim, Casambi). Colour temperatures 2200K, 2700K, 3000K, 3500K, 4000K or 6500K. Binning initial  $\leq$  MacAdam 3. Colour rendering CRI>80 or CRI>90. On request: Integration of emergency lighting components, sensor technology.

**FR** Luminaire LED en saillie pour murs et plafonds. Éclairage direct avec colerette de lumière indirecte ou uniquement éclairage direct. 6 diamètres différents de 300mm à 1200mm. Surface laquée blanc, argent, graphite, noir, champagne ou cuivre. Autres options de finition voir Lightnet-Surface-Collection ou RAL au choix. Diffuseur microprismatique optimisé pour un éblouissement limité et adapté aux bureaux. Diffuseur opale satiné pour un éclairage général et une transmission maximale et homogène. Driver intégré dans le luminaire, au choix ON/OFF ou graduable (1-10V, DALI, Touch-Dim, Casambi). Température de couleur 2200K, 2700K, 3000K, 3500K, 4000K ou 6500K. Binning initial  $\leq$  MacAdam 3. Rendu de couleur CRI>80 ou CRI>90. Sur demande: Intégration de composants d'éclairage de secours ou de capteurs.



**PRODUCT-CODE: B X1 O S D - 8 30 M - D300**

- PRODUCT FAMILY - **B** Basic
- TYPE - **X1** Direct-Indirect, **Y1** Direct Only
- OPTICAL SYSTEM - **A** Microprismatic, **O** Opal
- SURFACE FINISH - **W** Snow White, **V** Ivory White, **S** Radiant Silver, **U** Urban Graphite, **B** Jet Black, **H** Champagne Silver, **K** Satin Copper
- CONTROL GEAR - **E** On/Off, **L** DALI, **D** 1-10V, **H** Touch-Dim, **C** Casambi
- COLOUR REND. - **8** CRI>80, **9** CRI>90, **F** Full Spectrum
- COLOUR TEMP. - **22** 2200K, **27** 2700K, **30** 3000K, **35** 3500K, **40** 4000K, **65** 6500K, **TW** Tunable White 2700-6500K [D400-D1200]
- POWER - **E** Low Power, **M** Medium Power
- SIZE - Luminaire Diameter in mm: **D300**, **D400**, **D500**, **D600**, **D900**, **D1200**
- ON REQUEST - Radar Sensor, Emergency Module

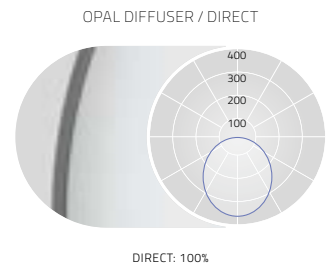
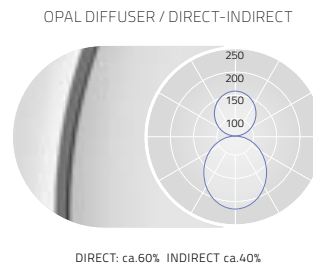
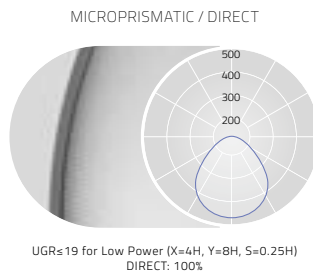
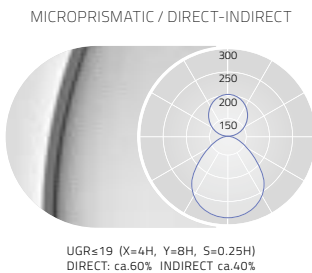

D mm	Lumen/Watt Low Power	Lumen/Watt Medium Power
300	1440lm/12W	2810lm/21W
400	2800lm/19W	5740lm/40W
500	3970lm/26W	7760lm/50W
600	8370lm/52W	12900lm/87W
900	11220lm/86W	17310lm/144W
1200	18260lm/157W	28420lm/266W

D mm	Lumen/Watt Low Power	Lumen/Watt Medium Power
300	880lm/8W	1730lm/14W
400	1740lm/13W	3580lm/29W
500	2480lm/18W	4860lm/35W
600	3860lm/28W	7250lm/52W
900	6800lm/59W	11490lm/106W
1200	11890lm/107W	20110lm/195W

D mm	Lumen/Watt Low Power	Lumen/Watt Medium Power
300	1470lm/12W	2860lm/21W
400	2850lm/19W	5850lm/40W
500	4040lm/26W	7910lm/50W
600	8490lm/52W	13120lm/87W
900	11420lm/86W	17650lm/144W
1200	18620lm/157W	29010lm/266W

D mm	Lumen/Watt Low Power	Lumen/Watt Medium Power
300	910lm/8W	1780lm/14W
400	1790lm/13W	3690lm/29W
500	2550lm/18W	5010lm/35W
600	3980lm/28W	7470lm/52W
900	7000lm/59W	11830lm/106W
1200	12250lm/107W	20700lm/195W

Lumen Values: Luminaire luminous flux at 4000K/CRI>80. Other configurations on request.



BEAM ME UP JR.  
SURFACE | Y3/X3



**DE** LED-Anbauleuchte für Wand- oder Deckenmontage mit rückversetzter Optik und dekorativem Reflektorring. Rein direktstrahlend oder direktstrahlend mit indirekter Lichtkorona. Leuchtschirm aus hochwertig verarbeiteten, glasfaserverstärktem Kunststoff (Fiberglas). Gehäuse-Außenfläche und dekorativer Reflektorring in unterschiedlichen Lackierungen und Kombinationen erhältlich, z.B. weiß, silber, graphit, schwarz, gold oder kupferfarben lackiert. Zu Oberflächenoptionen- und Kombinationen siehe Lightnet-Surface-Collection oder Bi-Colour-Auswahl. Microprismenoptik mit optimierter Blendungsbegrenzung speziell für Office-Anwendungen. Satinierter Opaldiffusor für Allgemeinbeleuchtung mit max. Transmissionsgrad und homogener Lichtpunktauflösung. Konverter in Leuchtgehäuse integriert, wahlweise einfach schaltbar oder stufenlos dimmbar (1-10V, DALI, Touch-Dim, Casambi). Farbtemperaturen 2200K, 2700K, 3000K, 3500K, 4000K oder 6500K. Binning initial  $\leq$  MacAdam 3. Farbwiedergabe CRI>80 oder CRI>90. Durchdachtes Montagesystem für einfache Installation und stabilen Halt.

**EN** LED surface-mounted luminaire for walls and ceilings with setback lens optic set in a decorative ring. Direct only light distribution or direct light distribution and indirect lighting corona. Luminaire body made of high-quality processed FRP (fiberglass reinforced plastic). Outer housing and decorative reflector ring available in various finishes and combinations, e.g. white, silver, graphite, black, gold or copper coated. For surface options and combinations check Lightnet Surface Collection or Bi-Colour Selection. Microprismatic with optimized glare reduction especially for workplaces. Satin opal diffuser for general lighting with maximum transmittance and homogeneous lighting. Converter integrated into luminaire housing, optionally switchable or dimmable (1-10V, DALI, Touch-Dim, Casambi). Colour temperatures 2200K, 2700K, 3000K, 3500K, 4000K or 6500K. Binning initial  $\leq$  MacAdam 3. Colour rendering CRI>80 or CRI>90. Sophisticated mounting system for easy installation and stable hold.

**FR** Luminaire LED montage mur/saillie/plafonnier avec diffuseur/optique en retrait et bague décorative. Éclairage uniquement direct ou direct avec corollette de lumière indirecte. Abat-Jour en matière travaillée hautement qualitative de fibre de verre. Surface du luminaire et réflecteur/bague décorative disponible en différentes combinaisons et couleurs au choix, Ex: blanc, argent, graphite, noir, ou en cuivre. Pour les options et combinaisons de finitions, voir Lightnet Surface Collection ou Bi-Colour Selection. Diffuseur microprismatique optimisé pour un éblouissement limité et adapté aux bureaux. Diffuseur opale satiné pour un éclairage général et une transmission maximale et homogène. Driver intégré dans le luminaire, au choix ON/OFF ou graduable (1-10V, DALI, Touch-Dim, Casambi). Température de couleur 2200K, 2700K, 3000K, 3500K, 4000K ou 6500K. Binning initial  $\leq$  MacAdam 3. Rendu de couleur CRI>80 ou CRI>90. Système de montage sophistiqué pour une installation facile et stable.



D [mm]	H [mm]
450	60
700	85
1100	125



**PRODUCT-CODE:** **MX3 OBD - 8 30 M - D450 - G**

PRODUCT FAMILY	- M: Beam Me Up
TYPE	- X3: Direct-Indirect, Y3: Direct Only
OPTICAL SYSTEM	- A: Microprismatic, O: Opal
SURFACE FINISH	- W: Snow White, V: Ivory White, A: Satin Silver, U: Urban Graphite, B: Jet Black, H: Champagne Silver, K: Satin Copper
CONTROL GEAR	- E: On/Off, L: DALI, D: 1-10V, H: Touch-Dim, C: Casambi
COLOUR REND.	- 8: CRI>80, 9: CRI>90
COLOUR TEMP.	- 22: 2200K, 27: 2700K, 30: 3000K, 35: 3500K, 40: 4000K, 65: 6500K, TW: Tunable White 2700-6500K
POWER	- M: Medium Power, H: High Power
SIZE	- Luminaire Diameter in mm: D450, D700, D1100
REFLECTOR	- W: Snow White, V: Ivory White, S: Radiant Silver, U: Urban Graphite, B: Jet Black, H: Champagne Silver, K: Satin Copper, G: Satin Gold
ON REQUEST	- Radar Sensor, Emergency Module

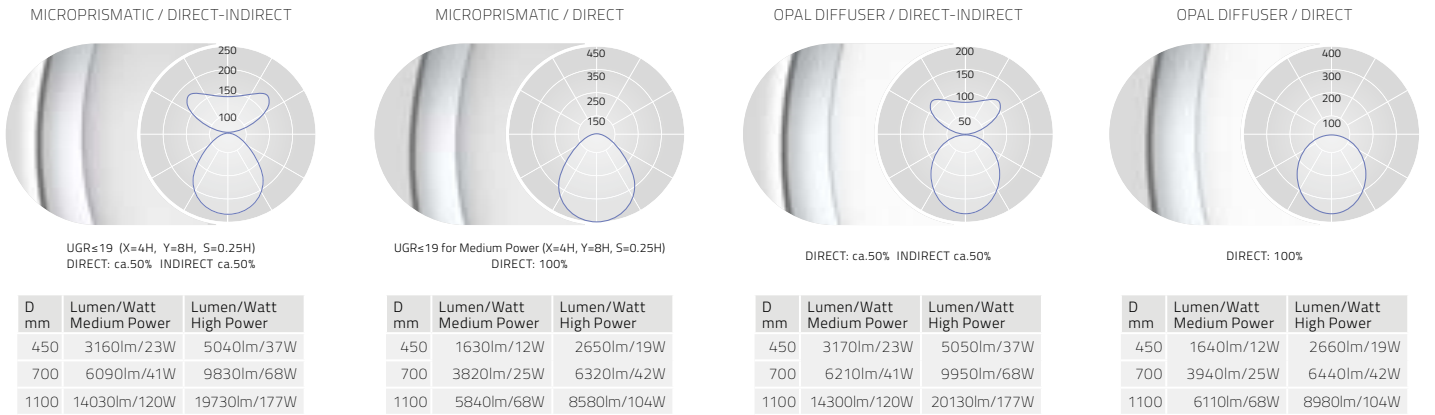

Lumen Values: Luminaire luminous flux at 4000K/CRI>80. Other configurations on request.





# BEAM ME UP SURFACE



MAN HEADQUARTERS, MUNICH, GERMANY  
BEAM ME UP-X1

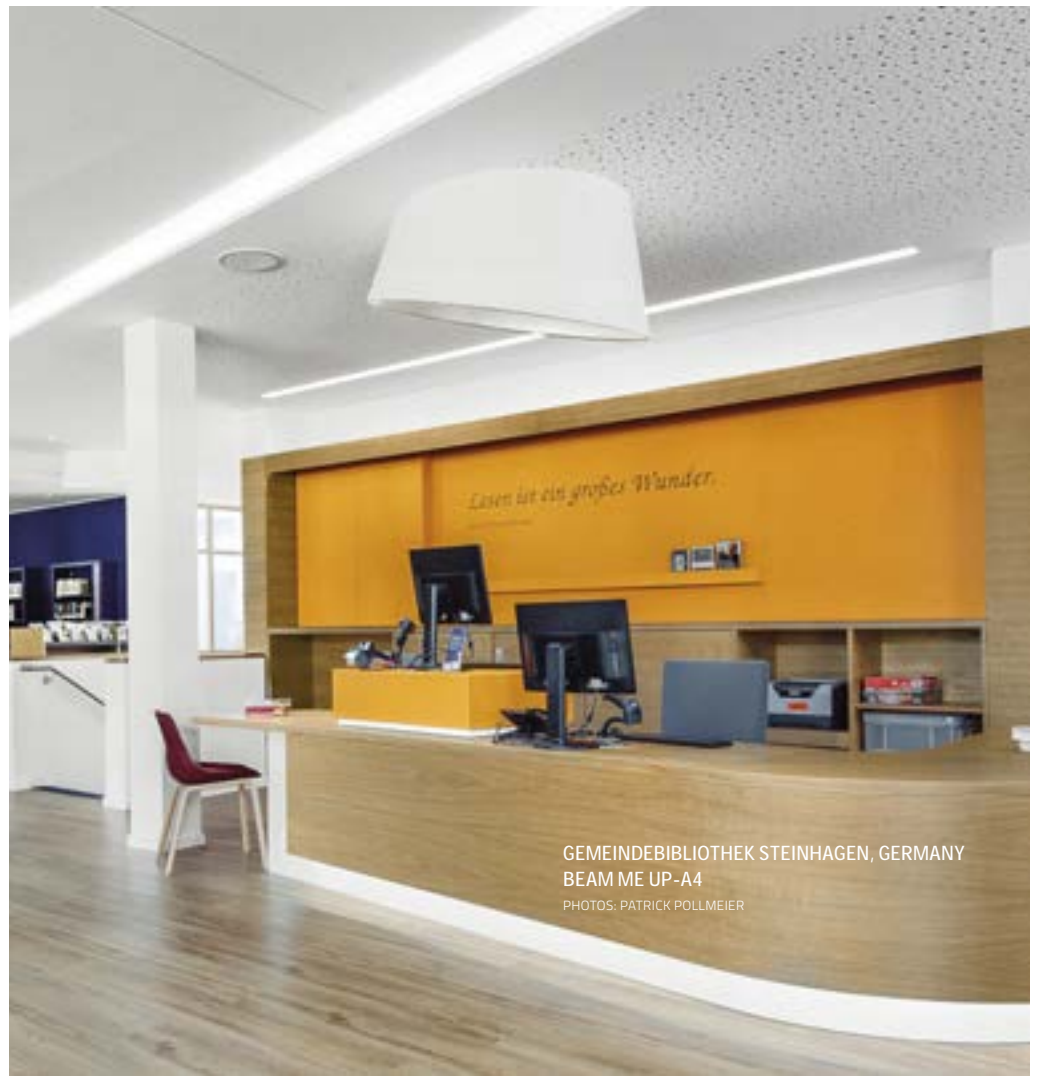

BEAM ME UP  
SURFACE | Y1/X1



**DE** LED-Anbauleuchte für Deckenmontage mit rückversetzter Optik und dekorativem Reflektorring. Rein direktstrahlend oder direktstrahlend mit indirekter Lichtkorona. Leuchtenschirm aus hochwertig verarbeitetem, glasfaserverstärktem Kunststoff (Fiberglas). Gehäuse-Außenfläche und dekorativer Reflektorring in unterschiedlichen Lackierungen und Kombinationen erhältlich, z.B. weiß, silber, graphit, schwarz, gold oder kupferfarben lackiert. Zu Oberflächenoptionen- und Kombinationen siehe Lightnet-Surface-Collection oder Bi-Colour-Auswahl. Microprismenoptik mit optimierter Blendungsbegrenzung speziell für Office-Anwendungen. Satinierter Opaldiffusor für Allgemeinbeleuchtung mit max. Transmissionsgrad und homogener Lichtpunktauflösung. Konverter in Leuchtengehäuse integriert, wahlweise einfach schaltbar oder stufenlos dimmbar (1-10V, DALI, Touch-Dim, Casambi). Farbtemperaturen 2200K, 2700K, 3000K, 3500K, 4000K oder 6500K. Binning initial  $\leq$  MacAdam 3. Farbwiedergabe CRI>80 oder CRI>90. Durchdachtes Montagesystem für einfache Installation und stabilen Halt.

**EN** LED surface-mounted luminaire for ceilings with setback lens optic set in a decorative ring. Direct only light distribution or direct light distribution and indirect lighting corona. Luminaire body made of high-quality processed FRP (fiberglass reinforced plastic). Outer housing and decorative reflector ring available in various finishes and combinations, e.g. white, silver, graphite, black, gold or copper coated. For surface options and combinations check Lightnet Surface Collection or Bi-Colour Selection. Microprismatic with optimized glare reduction especially for workplaces. Satin opal diffuser for general lighting with maximum transmittance and homogeneous lighting. Converter integrated into luminaire housing, optionally switchable or dimmable (1-10V, DALI, Touch-Dim, Casambi). Colour temperatures 2200K, 2700K, 3000K, 3500K, 4000K or 6500K. Binning initial  $\leq$  MacAdam 3. Colour rendering CRI>80 or CRI>90. Sophisticated mounting system for easy installation and stable hold.

**FR** Luminaire LED montage saillie/plafonnier avec diffuseur/optique en retrait et bague décorative. Éclairage uniquement direct ou direct avec colerette de lumière indirecte. Abat-Jour en matière travaillée hautement qualitative de fibre de verre. Surface du luminaire et réflecteur/bague décorative disponible en différentes combinaisons et couleurs au choix, Ex: blanc, argent, graphite, noir, or ou cuivre. Pour les options et combinaisons de finitions, voir Lightnet Surface Collection ou Bi-Colour Selection. Diffuseur microprismatique optimisé pour un éblouissement limité et adapté aux bureaux. Diffuseur opale satiné pour un éclairage général et une transmission maximale et homogène. Driver intégré dans le luminaire, au choix ON/OFF ou graduable (1-10V, DALI, Touch-Dim, Casambi). Température de couleur 2200K, 2700K, 3000K, 3500K, 4000K ou 6500K. Binning initial  $\leq$  MacAdam 3. Rendu de couleur CRI>80 ou CRI>90. Système de montage sophistiqué pour une installation facile et stable.



D [mm]	H1 [mm]	H2 [mm]
400	160	40
700	250	60
1200	350	60

**PRODUCT-CODE: M X1 O B D - 8 30 M - D400 - G**

- PRODUCT FAMILY – M: Beam Me Up
- TYPE – X1: Direct-Indirect, Y1: Direct Only
- OPTICAL SYSTEM – A: Microprismatic, O: Opal
- SURFACE FINISH – W: Snow White, V: Ivory White, A: Satin Silver, U: Urban Graphite, B: Jet Black, H: Champagne Silver, K: Satin Copper
- CONTROL GEAR – E: On/Off, L: DALI, D: 1-10V, H: Touch-Dim, C: Casambi
- COLOUR REND. – 8: CRI>80, 9: CRI>90, F: Full Spectrum
- COLOUR TEMP. – 22: 2200K, 27: 2700K, 30: 3000K, 35: 3500K, 40: 4000K, 65: 6500K, TW: Tunable White 2700-6500K
- POWER – M: Medium Power, H: High Power
- SIZE – Luminaire Diameter in mm: D400, D700, D1200
- REFLECTOR – W: Snow White, V: Ivory White, A: Satin Silver, U: Urban Graphite, B: Jet Black, H: Champagne Silver, K: Satin Copper, G: Satin Gold
- ON REQUEST – Radar Sensor, Emergency Module

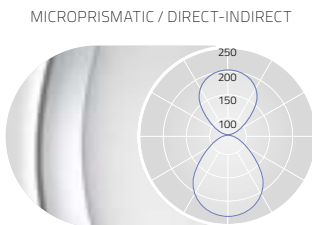

UGR $\leq$ 16 (X=4H, Y=8H, S=0.25H)  
DIRECT: ca.50% INDIRECT ca.50%

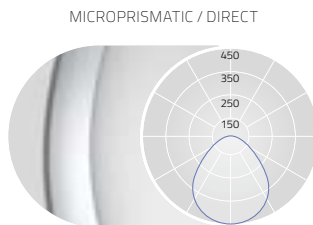

UGR $\leq$ 19 for Medium Power (X=4H, Y=8H, S=0.25H)  
DIRECT: 100%

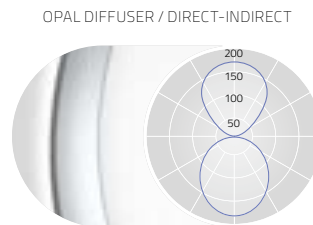

DIRECT: ca.50% INDIRECT ca.50%

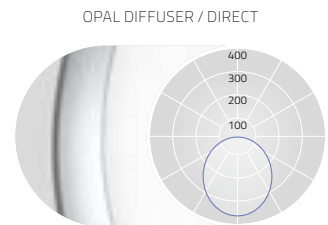

DIRECT: 100%

D mm	Lumen/Watt Medium Power	Lumen/Watt High Power
400	2160lm/20W	3160lm/32W
700	5790lm/50W	8490lm/80W
1200	19470lm/177W	26780lm/247W

D mm	Lumen/Watt Medium Power	Lumen/Watt High Power
400	1090lm/14W	1600lm/22W
700	2920lm/35W	4290lm/52W
1200	8580lm/104W	11220lm/139W

D mm	Lumen/Watt Medium Power	Lumen/Watt High Power
400	2210lm/20W	3240lm/32W
700	5930lm/50W	8690lm/80W
1200	19870lm/177W	27310lm/247W

D mm	Lumen/Watt Medium Power	Lumen/Watt High Power
400	1140lm/14W	1680lm/22W
700	3060lm/35W	4490lm/52W
1200	8980lm/104W	11750lm/139W



# BEAM ME UP WALLWASHER SURFACE | A4



**DE** LED-Anbauleuchte für Deckenmontage mit rückversetzter Optik und dekorativem Reflektorring. Rein direkt- und breitflächig asymmetrisch abstrahlend. Leuchtschirm aus hochwertig verarbeitetem, glasfaserverstärktem Kunststoff (Fiberglas). Gehäuse-Außenfläche und dekorativer Reflektorring in unterschiedlichen Lackierungen und Kombinationen erhältlich, z.B. weiß, silber, graphit, schwarz, gold oder kupferfarben lackiert. Zu Oberflächenoptionen- und Kombinationen siehe Lightnet-Surface-Collection oder Bi-Colour-Auswahl. Microprismenoptik mit optimierter Blendungsbegrenzung speziell für Office-Anwendungen. Satiniertes Opaldiffusor für Allgemeinbeleuchtung mit max. Transmissionsgrad und homogener Lichtpunktauflösung. Konverter in Leuchtgehäuse integriert, wahlweise einfach schaltbar oder stufenlos dimmbar (1-10V, DALI, Touch-Dim, Casambi). Farbtemperaturen 2200K, 2700K, 3000K, 3500K, 4000K oder 6500K. Binning initial  $\leq$  MacAdam 3. Farbwiedergabe CRI>80 oder CRI>90.

**EN** LED surface-mounted luminaire for ceilings with setback lens optic set in a decorative ring. Direct only light distribution with wide asymmetrical beam angle. Luminaire body made of high-quality processed FRP (fiberglass reinforced plastic). Outer housing and decorative reflector ring available in various finishes and combinations, e.g. white, silver, graphite, black, gold or copper coated. For surface options and combinations check Lightnet Surface Collection or Bi-Colour Selection. Microprismatic with optimized glare reduction especially for workplaces. Satin opal diffuser for general lighting with maximum transmittance and homogeneous lighting. Converter integrated into luminaire housing, optionally switchable or dimmable (1-10V, DALI, Touch-Dim, Casambi). Colour temperatures 2200K, 2700K, 3000K, 3500K, 4000K or 6500K. Binning initial  $\leq$  MacAdam 3. Colour rendering CRI>80 or CRI>90.

**FR** Luminaire LED montage saillie/plafonnier avec diffuseur/optique en retrait et bague décorative. Éclairage uniquement direct avec réflexion large asymétrique. Abat-Jour en matière travaillée hautement qualitative de fibre de verre. Surface du luminaire et réflecteur/bague décorative disponible en différentes combinaisons et couleurs au choix, Ex: blanc, argent, graphite, noir, or ou cuivre. Pour les options et combinaisons de finitions, voir Lightnet Surface Collection ou Bi-Colour Selection. Diffuseur microprismatique optimisé pour un éblouissement limité et adapté aux bureaux. Diffuseur opale satiné pour un éclairage général et une transmission maximale et homogène. Driver intégré dans le luminaire, au choix ON/OFF ou graduable (1-10V, DALI, Touch-Dim, Casambi). Température de couleur 2200K, 2700K, 3000K, 3500K, 4000K ou 6500K. Binning initial  $\leq$  MacAdam 3. Rendu de couleur CRI>80 ou CRI>90.

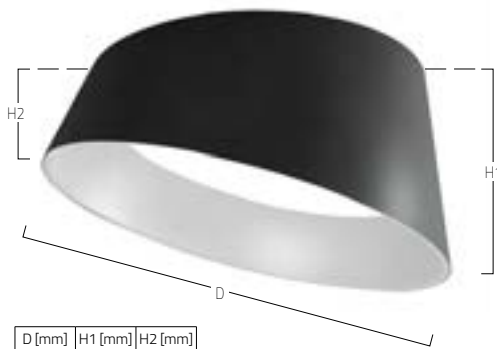

D [mm]	H1 [mm]	H2 [mm]
700	360	179
1200	580	269

**PRODUCT-CODE: MA4 O B D - 8 30 M - D700 - G**

- PRODUCT FAMILY — **M**: Beam Me Up
- TYPE — **A4**: Direct Wallwasher
- OPTICAL SYSTEM — **A**: Microprismatic, **O**: Opal
- SURFACE FINISH — **W**: Snow White, **V**: Ivory White, **A**: Satin Silver, **U**: Urban Graphite, **B**: Jet Black, **H**: Champagne Silver, **K**: Satin Copper
- CONTROL GEAR — **E**: On/Off, **L**: DALI, **D**: 1-10V, **H**: Touch-Dim, **C**: Casambi
- COLOUR REND. — **8**: CRI>80, **9**: CRI>90, **F**: Full Spectrum
- COLOUR TEMP. — **22**: 2200K, **27**: 2700K, **30**: 3000K, **35**: 3500K, **40**: 4000K, **65**: 6500K, **TW**: Tunable White 2700-6500K
- POWER — **M**: Medium Power, **H**: High Power
- SIZE — Luminaire Diameter in mm: **D700**, **D1200**
- REFLECTOR — **W**: Snow White, **V**: Ivory White, **A**: Satin Silver, **U**: Urban Graphite, **B**: Jet Black, **H**: Champagne Silver, **K**: Satin Copper, **G**: Satin Gold
- ON REQUEST — Radar Sensor, Emergency Module

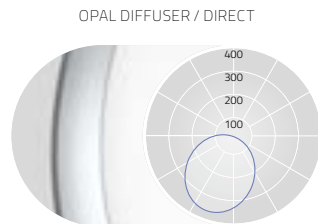
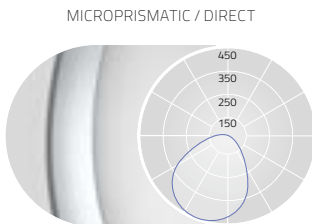

UGR $\leq$ 19 for Medium Power (X=4H, Y=8H, S=0.25H)  
DIRECT: 100%

DIRECT: 100%

D mm	Lumen/Watt Medium Power	Lumen/Watt High Power
700	3060lm/35W	4490lm/52W
1200	8980lm/104W	11750lm/139W

D mm	Lumen/Watt Medium Power	Lumen/Watt High Power
700	3160lm/35W	4650lm/52W
1200	9300lm/104W	12160lm/139W

Lumen Values: Luminaire luminous flux at 4000K/CRI>80. Other configurations on request.



# RINGO STAR SURFACE



KANTINE BAYER, WUPPERTAL, GERMANY  
RINGO STAR-A1



THEO SHOPPING-CENTER, HUSUM, GERMANY  
RINGO STAR-A1



RINGO STAR 60MM  
SURFACE | A3



**DE** LED-Anbauleuchte für Wand- oder Deckenmontage. Rein direktstrahlend. Leuchtenkörper aus Aluminiumprofil mit 60mm Lichtspurbreite. 13 verschiedene Durchmesser von 600mm bis 8000mm. Oberfläche silber, weiß, graphit, schwarz, champagner oder kupferfarben lackiert. Weitere Oberflächenoptionen siehe Lightnet-Surface-Collection oder RAL nach Wahl. Microprismenoptik mit optimierter Blendungsbegrenzung speziell für Office-Anwendungen. Satinierter Opaldiffusor für Allgemeinbeleuchtung mit max. Transmissionsgrad und homogener Lichtpunktauflösung. Konverter in Leuchtengehäuse integriert, wahlweise einfach schaltbar oder stufenlos dimmbar (1-10V, DALI, Touch-Dim, Casambi). Farbtemperaturen 2200K, 2700K, 3000K, 3500K, 4000K oder 6500K. Binning initial  $\leq$  MacAdam 3. Colour rendering CRI>80 oder CRI>90.

**EN** LED surface-mounted luminaire for walls or ceilings. Direct only light distribution. Luminaire body made of aluminium profile with 60mm track width. 13 different diameters from 600mm to 8000mm. Surface silver, white, graphite, black, champagne or copper coated. Further surface options see Lightnet-Surface-Collection or RAL of your choice. Microprismatic with optimized glare reduction especially for workplaces. Satin opal diffuser for general lighting with maximum transmittance and homogeneous lighting. Converter integrated into luminaire housing, optionally switchable or dimmable (1-10V, DALI, Touch-Dim, Casambi). Colour temperatures 2200K, 2700K, 3000K, 3500K, 4000K or 6500K. Binning initial  $\leq$  MacAdam 3. Colour rendering CRI>80 or CRI>90.

**FR** Luminaire LED en saillie pour murs et plafonds. Éclairage seulement direct. Corps du luminaire en profilé aluminium avec 60mm de largeur du spectre lumineux. 13 diamètres différents de 600mm à 8000mm. Surface laquée argent, blanc, graphite, noir, champagne ou cuivre. Autres options de finition voir Lightnet-Surface-Collection ou RAL au choix. Diffuseur microprismatique optimisé pour un éblouissement limité et adapté aux bureaux. Diffuseur opale satiné pour un éclairage général et une transmission maximale et homogène. Driver intégré dans le luminaire, au choix ON/OFF ou graduable (1-10V, DALI, Touch-Dim, Casambi). Température de couleur 2200K, 2700K, 3000K, 3500K, 4000K ou 6500K. Binning initial  $\leq$  MacAdam 3. Rendu de couleur CRI>80 ou CRI>90.



**PRODUCT-CODE:** R A3 O S D - 8 30 M - D1500

- PRODUCT FAMILY – R: Ringo Star
- TYPE – A3: Direct Only
- OPTICAL SYSTEM – O: Opal, A: Microprismatic
- SURFACE FINISH – W: Snow White, V: Ivory White, S: Radiant Silver, U: Urban Graphite, B: Jet Black, H: Champagne Silver, K: Satin Copper
- CONTROL GEAR – E: On/Off, L: DALI, D: 1-10V, H: Touch-Dim, C: Casambi
- COLOUR REND. – 8: CRI>80, 9: CRI>90, F: Full Spectrum
- COLOUR TEMP. – 22: 2200K, 27: 2700K, 30: 3000K, 35: 3500K, 40: 4000K, 65: 6500K, TW: Tunable White 2700-6500K
- POWER – M: Medium Power, H: High Power
- SIZE – Luminaire Diameter in mm: D600, D900, D1200, D1500, D2000, D2500, D3000, D3500, D4000, D5000, D6000, D7000, D8000
- ON REQUEST – Emergency Module



MICROPRISMATIC / DIRECT

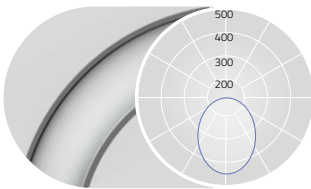

DIRECT: 100%

OPAL DIFFUSER / DIRECT

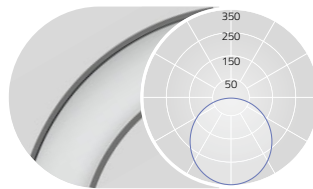

DIRECT: 100%

D mm	Lumen/Watt Medium Power	Lumen/Watt High Power
600	2480lm/25W	3750lm/38W
900	4100lm/39W	5620lm/55W
1200	5320lm/50W	7210lm/70W
1500	7090lm/66W	9620lm/92W
2000	8340lm/87W	12200lm/132W
2500	10840lm/112W	15860lm/172W
3000	13340lm/137W	19520lm/207W
3500	15850lm/162W	23180lm/248W
4000	16680lm/171W	24400lm/259W
5000	21680lm/221W	31720lm/340W
6000	26690lm/272W	39040lm/414W
7000	30020lm/305W	43920lm/466W
8000	35030lm/355W	51240lm/547W

D mm	Lumen/Watt Medium Power	Lumen/Watt High Power
600	2060lm/25W	3110lm/38W
900	3410lm/39W	4670lm/55W
1200	4420lm/50W	5990lm/70W
1500	5890lm/66W	7990lm/92W
2000	6970lm/87W	10200lm/132W
2500	9060lm/112W	13260lm/172W
3000	11160lm/137W	16320lm/207W
3500	13250lm/162W	19380lm/248W
4000	13950lm/171W	20400lm/259W
5000	18130lm/221W	26520lm/340W
6000	22310lm/272W	32640lm/414W
7000	25100lm/305W	36720lm/466W
8000	29290lm/355W	42840lm/547W

Lumen Values: Luminaire luminous flux at 4000K/CRI>80 / surface finished Snow White. Other configurations on request.



RINGO STAR 100MM  
SURFACE | A1



**DE** LED-Anbauleuchte für Wand- oder Deckenmontage. Rein direktstrahlend. Leuchtenkörper aus Aluminiumprofil mit 100mm Lichtspurbreite. 13 verschiedene Durchmesser von 600mm bis 8000mm. Oberfläche silber, weiß, graphit, schwarz, champagner oder kupferfarben lackiert. Weitere Oberflächenoptionen siehe Lightnet-Surface-Collection oder RAL nach Wahl. Microprismenoptik mit optimierter Blendungsbegrenzung speziell für Office-Anwendungen. Satinierter Opaldiffusor für Allgemeinbeleuchtung mit max. Transmissionsgrad und homogener Lichtpunktauflösung. Konverter in Leuchtengehäuse integriert, wahlweise einfach schaltbar oder stufenlos dimmbar (1-10V, DALI, Touch-Dim, Casambi). Farbtemperaturen 2200K, 2700K, 3000K, 3500K, 4000K oder 6500K. Binning initial ≤ MacAdam 3. Colour rendering CRI>80 oder CRI>90.

**EN** LED surface-mounted luminaire for walls or ceilings. Direct only light distribution. Luminaire body made of aluminium profile with 100mm track width. 13 different diameters from 600mm to 8000mm. Surface silver, white, graphite, black, champagne or copper coated. Further surface options see Lightnet-Surface-Collection or RAL of your choice. Microprismatic with optimized glare reduction especially for workplaces. Satin opal diffuser for general lighting with maximum transmittance and homogeneous lighting. Converter integrated into luminaire housing, optionally switchable or dimmable (1-10V, DALI, Touch-Dim, Casambi). Colour temperatures 2200K, 2700K, 3000K, 3500K, 4000K or 6500K. Binning initial ≤ MacAdam 3. Colour rendering CRI>80 or CRI>90.

**FR** Luminaire LED en saillie pour murs et plafonds. Éclairage seulement direct. Corps du luminaire en profilé aluminium avec 100mm de largeur du spectre lumineux. 13 diamètres différents de 600mm à 8000mm. Surface laquée argent, blanc, graphite, noir, champagne ou cuivre. Autres options de finition voir Lightnet-Surface-Collection ou RAL au choix. Diffuseur microprismatique optimisé pour un éblouissement limité et adapté aux bureaux. Diffuseur opale satiné pour un éclairage général et une transmission maximale et homogène. Driver intégré dans le luminaire, au choix ON/OFF ou graduable (1-10V, DALI, Touch-Dim, Casambi). Température de couleur 2200K, 2700K, 3000K, 3500K, 4000K ou 6500K. Binning initial ≤ MacAdam 3. Rendu de couleur CRI>80 ou CRI>90.

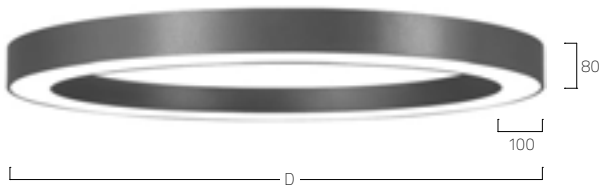

**PRODUCT-CODE: R A1 O S D - 8 30 M - D1500**

- PRODUCT FAMILY - **R**: Ringo Star
- TYPE - **A1**: Direct Only
- OPTICAL SYSTEM - **O**: Opal, **A**: Microprismatic
- SURFACE FINISH - **W**: Snow White, **V**: Ivory White, **S**: Radiant Silver, **U**: Urban Graphite, **B**: Jet Black, **H**: Champagne Silver, **K**: Satin Copper
- CONTROL GEAR - **E**: On/Off, **L**: DALI, **D**: 1-10V, **H**: Touch-Dim, **C**: Casambi
- COLOUR REND. - **8**: CRI>80, **9**: CRI>90, **F**: Full Spectrum
- COLOUR TEMP. - **22**: 2200K, **27**: 2700K, **30**: 3000K, **35**: 3500K, **40**: 4000K, **65**: 6500K, **TW**: Tunable White 2700-6500K
- POWER - **E**: Low Power, **M**: Medium Power
- SIZE - Luminaire Diameter in mm: **D600, D900, D1200, D1500, D2000, D2500, D3000, D3500, D4000, D5000, D6000, D7000, D8000**
- ON REQUEST - Emergency Module



MICROPRISMATIC / DIRECT

OPAL DIFFUSER / DIRECT

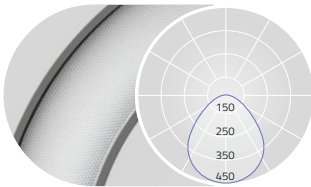

DIRECT: 100%

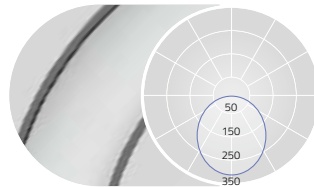

DIRECT: 100%

D mm	Lumen/Watt Low Power	Lumen/Watt Medium Power
600	2600lm/25W	3560lm/35W
900	4140lm/39W	5580lm/54W
1200	6250lm/56W	8430lm/78W
1500	7770lm/70W	10450lm/102W
2000	10360lm/91W	13940lm/124W
2500	14510lm/124W	19410lm/156W
3000	17860lm/138W	23890lm/188W
3500	20090lm/157W	26870lm/214W
4000	23440lm/193W	31350lm/250W
5000	29020lm/225W	38810lm/307W
6000	35710lm/275W	47770lm/375W
7000	42410lm/329W	56730lm/448W
8000	47430lm/372W	63450lm/500W

D mm	Lumen/Watt Low Power	Lumen/Watt Medium Power
600	2690lm/25W	3680lm/35W
900	4290lm/39W	5770lm/54W
1200	6470lm/56W	8720lm/78W
1500	8040lm/70W	10820lm/102W
2000	10710lm/91W	14420lm/124W
2500	12500lm/124W	16720lm/156W
3000	15390lm/138W	20580lm/188W
3500	17310lm/157W	23160lm/214W
4000	20200lm/193W	27020lm/250W
5000	25010lm/225W	33450lm/307W
6000	30780lm/275W	41170lm/375W
7000	36550lm/329W	48890lm/448W
8000	40880lm/372W	54670lm/500W

Lumen Values: Luminaire luminous flux at 4000K/CRI>80 / surface finished Snow White. Other configurations on request.



# LIQUID LINE SURFACE





# LIQUID LINE SURFACE | A3



**DE** LED-System-Anbauleuchte. Rein direktstrahlend. Leuchtenkörper aus Aluminiumprofil mit 60mm Lichtspurbreite. Oberfläche weiß, silber, graphit, schwarz, champagner oder kupferfarben lackiert. Weitere Oberflächenoptionen siehe Lightnet-Surface-Collection oder RAL nach Wahl. Microprismenoptik mit optimierter Blendungsbegrenzung speziell für Office-Anwendungen. Satiniertes Opaldiffusor für Allgemeinbeleuchtung. Konverter in Leuchtgehäuse integriert, wahlweise einfach schaltbar oder stufenlos dimmbar (1-10V, DALI, Touch-Dim, Casambi). Farbtemperaturen 2200K, 2700K, 3000K, 3500K, 4000K oder 6500K. Binning initial  $\leq$  MacAdam 3. Farbwiedergabe CRI>80 oder CRI>90. Beliebige Kombination vorgefertigter X-Verbinde mit allen linearen sowie gebogenen Elementen der Familie Liquid Line 3D übergreifend möglich. Hochflexibles System geeignet für millimetergenauen Zuschnitt auf Maß sowie Individuallösungen. Jedes Modul auch als Einzeleuchte erhältlich. Stirnseiten sind separat zu bestellen. Bei Lichtbandmontage ist für jede Stoßstelle ein Verbinder separat zu bestellen.

**EN** LED surface mounted light system. Direct only light distribution. Luminaire body made of aluminium profile with 60mm width. Surface white, silver, graphite, black, champagne or copper coated. Further surface options see Lightnet-Surface-Collection or RAL of your choice. Microprismatic with optimized glare reduction especially for workplaces. Satin opal diffuser for general lighting. Driver integrated into luminaire housing, optionally switchable or dimmable (1-10V, DALI, Touch-Dim, Casambi). Colour temperatures 2200K, 2700K, 3000K, 3500K, 4000K or 6500K. Binning initial  $\leq$  MacAdam 3. Colour rendering CRI>80 or CRI>90. Arbitrary combination of all 90° modules, X- and Y-connectors, linear and curved elements of the Liquid Line 3D family is possible. Highly flexible system suited for millimetre accurate customizing as well as individual solutions. Each module is also available as stand-alone luminaire. End caps to be ordered separately.

**FR** Système d'éclairage modulaire LED. Éclairage seulement direct. Corps du luminaire en profilé aluminium avec 60mm de largeur du spectre lumineux. Surface laquée blanc, argent, graphite, noir, champagne ou cuivre. Autres options de finition voir Lightnet-Surface-Collection ou RAL au choix. Diffuseur microprismatique optimisé pour un éblouissement limité et adapté aux bureaux. Diffuseur opale satinée pour un éclairage général. Driver intégré dans le luminaire, au choix ON/OFF ou graduable (1-10V, DALI, Touch-Dim, Casambi). Température de couleur 2200K, 2700K, 3000K, 3500K, 4000K ou 6500K. Binning initial  $\leq$  MacAdam 3. Rendu de couleur CRI>80 ou CRI>90. Combinaison possible et mélangée au choix de tous les modules angle à 90°, en forme de X- et Y-, éléments droits et ceintrés de la famille Liquid Line 3D. Système d'éclairage hautement flexible adapté pour des solutins individuelles multiples au millimètre près. Chaque module disponible comme luminaire indépendant autonome. Cache frontal à commander séparément.

## LINEAR MODULES

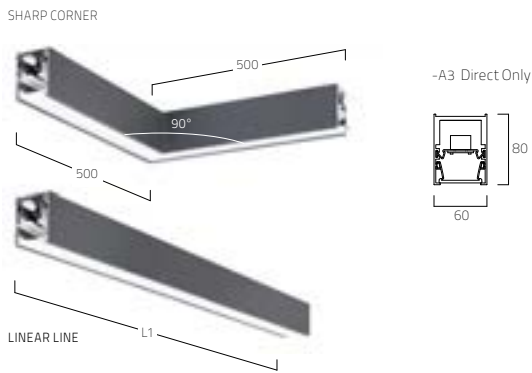

**PRODUCT-CODE:** Q A3 A S E - 8 30 M - L 1178

PRODUCT FAMILY	- Q: Liquid Line
TYPE	- A3: Direct Only
OPTICAL SYSTEM	- A: Microprismatic, O: Opal
SURFACE FINISH	- W: Snow White, V: Ivory White,
	S: Radiant Silver, U: Urban Graphite, B: Jet Black,
	H: Champagne Silver, K: Satin Copper
CONTROL GEAR	- E: On/Off, L: DALI, D: 1-10V, H: Touch-Dim, C: Casambi
COLOUR REND.	- 8: CRI>80, 9: CRI>90, F: Full Spectrum
COLOUR TEMP.	- 22: 2200K, 27: 2700K, 30: 3000K, 35: 3500K, 40: 4000K, 65: 6500K
POWER	- E: Low Power, M: Medium Power, H: High Power
FORM	- L: Line, K: Corner
SIZE	- Line Length in mm: 600, 888, 1178, 1472, 2340, Corner: 500x500
ON REQUEST	- Emergency Module, Tunable White



## BEND MODULES

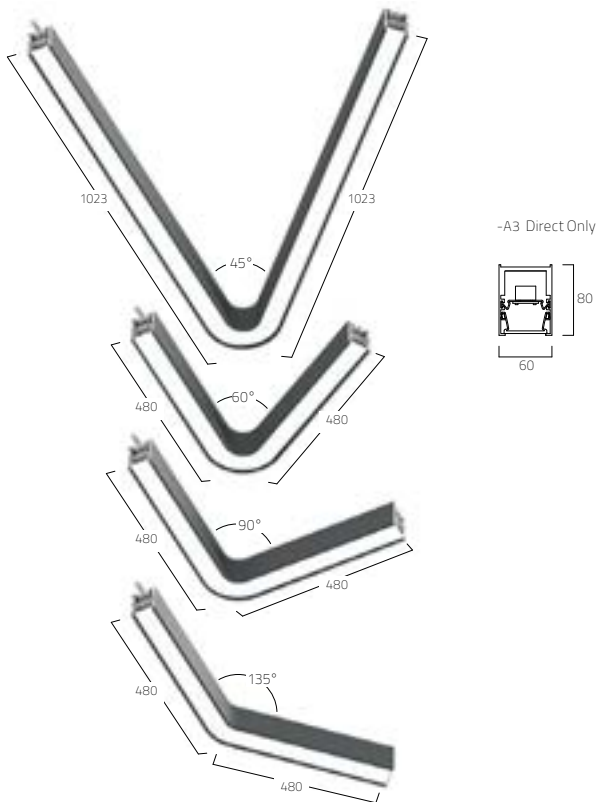

**PRODUCT-CODE:** Q A3 A S E - 8 30 M - B 135

PRODUCT FAMILY	- Q: Liquid Line
TYPE	- A3: Direct Only
OPTICAL SYSTEM	- A: Microprismatic, O: Opal
SURFACE FINISH	- W: Snow White, V: Ivory White,
	S: Radiant Silver, U: Urban Graphite, B: Jet Black,
	H: Champagne Silver, K: Satin Copper
CONTROL GEAR	- E: On/Off, L: DALI, D: 1-10V, H: Touch-Dim, C: Casambi
COLOUR REND.	- 8: CRI>80, 9: CRI>90, F: Full Spectrum
COLOUR TEMP.	- 22: 2200K, 27: 2700K, 30: 3000K, 35: 3500K, 40: 4000K, 65: 6500K
POWER	- E: Low Power, M: Medium Power, H: High Power
FORM	- B: Bend Module
SIZE	- Degree: 45°, 60°, 90°, 135°
ON REQUEST	- Emergency Module, Tunable White



## CURVE MODULES

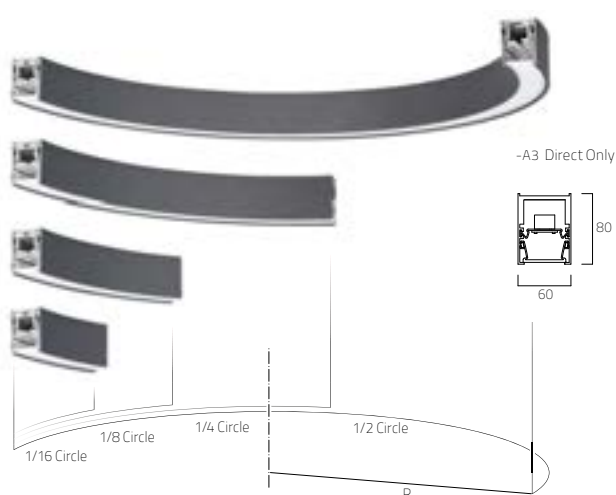

**PRODUCT-CODE:** Q A3 O S E - 8 30 M - CH - R050 - L1570

PRODUCT FAMILY	- Q: Liquid Line
TYPE	- A3: Direct-Indirect
OPTICAL SYSTEM	- A: Microprismatic, O: Opal
SURFACE FINISH	- W: Snow White, V: Ivory White,
	S: Radiant Silver, U: Urban Graphite, B: Jet Black,
	H: Champagne Silver, K: Satin Copper
CONTROL GEAR	- E: On/Off, L: DALI, D: 1-10V, H: Touch-Dim, C: Casambi
COLOUR REND.	- 8: CRI>80, 9: CRI>90, F: Full Spectrum
COLOUR TEMP.	- 22: 2200K, 27: 2700K, 30: 3000K,
	35: 3500K, 40: 4000K, 65: 6500K
POWER	- E: Low Power, M: Medium Power, H: High Power
FORM	- C: Curve Module
ARC SECTION	- H: 1/2 curve, Q: 1/4 curve, E: 1/8 curve, S: 1/16 curve
RADIUS	- R050: R500mm, R075: R750mm, R100: R1000mm, R125: R1250mm,
	R150: R1500mm, R175: R1750mm, R200: R2000mm, R250: R2500mm,
	R300: R3000mm, R350: R3500mm, R400: R4000mm
LENGTH	- Length in mm
ON REQUEST	- Emergency Module, Tunable White

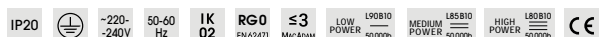



LIQUID LINE  
SURFACE | A3



## WAVE MODULES

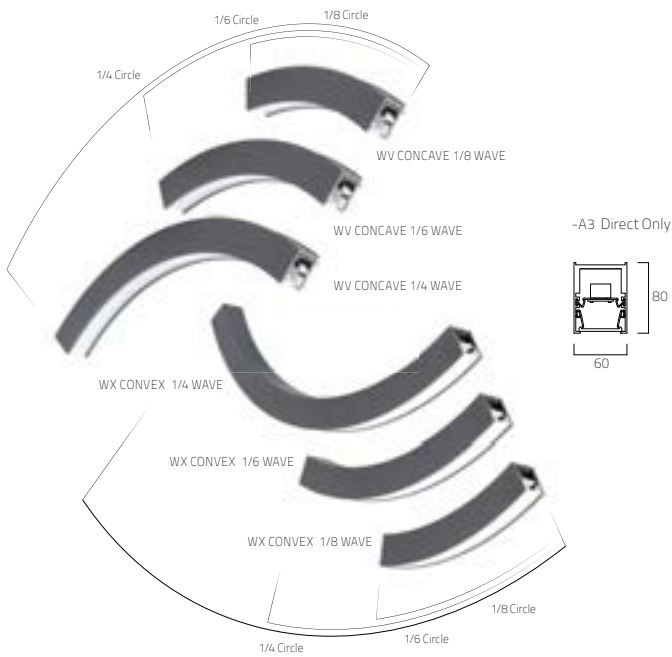

**PRODUCT-CODE:** Q A3 O S E - 8 30 E - W X E - R100 - L848

PRODUCT FAMILY	Q: Liquid Line
TYPE	A3: Direct Only
OPTICAL SYSTEM	A: Microprismatic, O: Opal
SURFACE FINISH	W: Snow White, V: Ivory White, S: Radiant Silver, U: Urban Graphite, B: Jet Black, H: Champagne Silver, K: Satin Copper
CONTROL GEAR	E: On/Off, L: DALI, D: 1-10V, H: Touch-Dim, C: Casambi
COLOUR REND.	8: CRI>80, 9: CRI>90, F: Full Spectrum
COLOUR TEMP.	22: 2200K, 27: 2700K, 30: 3000K, 35: 3500K, 40: 4000K, 65: 6500K
POWER	E: Low Power, M: Medium Power, H: High Power
WAVE TYPE	WX: Convex, WV: Concave
WAVE SECTION	Q: 1/4 wave, S: 1/6 wave, E: 1/8 wave
RADIUS	R100: R1000mm, R125: R1250mm, R150: R1500mm
LENGTH	Length in mm
ON REQUEST	Emergency Module, Tunable White



## Y-JUNCTIONS

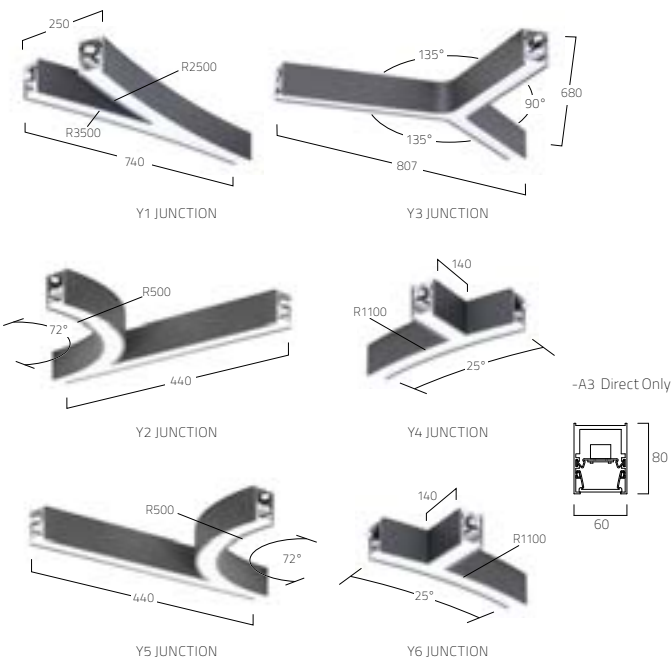

**PRODUCT-CODE:** Q A3 O S E - 8 30 M - Y 1 - L1450

PRODUCT FAMILY	Q: Liquid Line
TYPE	A3: Direct Only
OPTICAL SYSTEM	A: Microprismatic, O: Opal
SURFACE FINISH	W: Snow White, V: Ivory White, S: Radiant Silver, U: Urban Graphite, B: Jet Black, H: Champagne Silver, K: Satin Copper
CONTROL GEAR	E: On/Off, L: DALI, D: 1-10V, H: Touch-Dim, C: Casambi
COLOUR REND.	8: CRI>80, 9: CRI>90, F: Full Spectrum
COLOUR TEMP.	22: 2200K, 27: 2700K, 30: 3000K, 35: 3500K, 40: 4000K, 65: 6500K
POWER	E: Low Power, M: Medium Power, H: High Power
JUNCTION FORM	Y: Y-Junction
JUNCTION TYPE	Type: 1, 2, 3, 4, 5, 6
LENGTH	Length in mm
ON REQUEST	Emergency Module, Tunable White



## X-JUNCTIONS

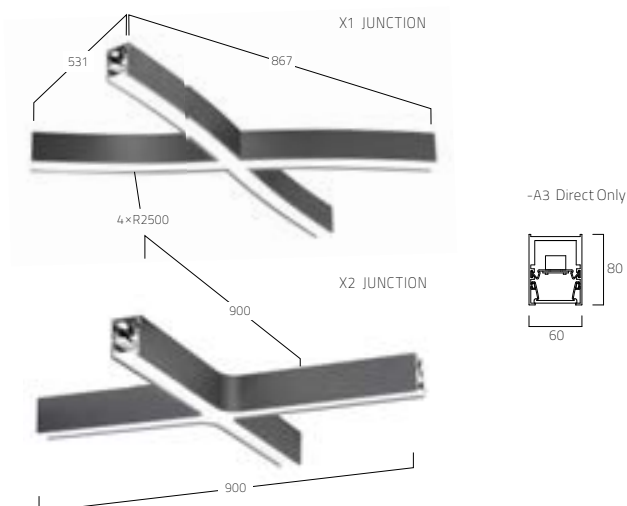

**PRODUCT-CODE:** Q A3 O S E - 8 30 M - X 1 - L1800

PRODUCT FAMILY	Q: Liquid Line
TYPE	A3: Direct Only
OPTICAL SYSTEM	A: Microprismatic, O: Opal
SURFACE FINISH	W: Snow White, V: Ivory White, S: Radiant Silver, U: Urban Graphite, B: Jet Black, H: Champagne Silver, K: Satin Copper
CONTROL GEAR	E: On/Off, L: DALI, D: 1-10V, H: Touch-Dim, C: Casambi
COLOUR REND.	8: CRI>80, 9: CRI>90, F: Full Spectrum
COLOUR TEMP.	22: 2200K, 27: 2700K, 30: 3000K, 35: 3500K, 40: 4000K, 65: 6500K
POWER	E: Low Power, M: Medium Power, H: High Power
JUNCTION FORM	X: X-Junction
JUNCTION TYPE	Type: 1, 2
LENGTH	Length in mm
ON REQUEST	Emergency Module, Tunable White



THREE PEAKS  
SURFACE | A



**DE** LED- Anbauleuchte. Rein Direktstrahlend. Leuchtenkörper aus Aluminiumprofil in unterschiedlichen Formen erhältlich. Oberfläche silber, weiß, graphit, schwarz, champagner oder kupferfarbenlackiert. Weitere Oberflächenoptionen siehe Lightnet-Surface-Collection oder RAL nach Wahl. Microprismenoptik mit optimierter Blendungsbegrenzung speziell für Office-Anwendungen. Satinierter Opaldiffusor für Allgemeinbeleuchtung. Konverter in Leuchtgehäuse integriert, wahlweise einfach schaltbar oder stufenlos dimmbar (1-10V, DALI, Touch-Dim, Casambi). Farbtemperaturen 2200K, 2700K, 3000K, 3500K, 4000K oder 6500K. Binning initial  $\leq$  MacAdam 3. Farbwiedergabe CRI>80 oder CRI>90.

**EN** LED surface-mounted luminaire. Direct only light distribution. Luminaire body made of aluminium profile available in various shapes. Surface silver, white, graphite, black, champagne or copper coated. Further surface options see Lightnet-Surface-Collection or RAL of your choice. Microprismatic with optimized glare reduction especially for workplaces. Satin opal diffuser for general lighting. Converter integrated into luminaire housing, optionally switchable or dimmable (1-10V, DALI, Touch-Dim, Casambi). Colour temperatures 2200K, 2700K, 3000K, 3500K, 4000K or 6500K. Binning initial  $\leq$  MacAdam 3. Colour rendering CRI>80 or CRI>90.

**FR** Luminaire LED en saillie. Éclairage seulement direct. Luminaire triangulaire en profilé aluminium disponible sous différentes formes. Surface laquée argent, blanc, graphite, noir, champagne ou cuivre. Autres options de finition voir Lightnet-Surface-Collection ou RAL au choix. Diffuseur microprismatique optimisé pour un éblouissement limité et adapté aux bureaux. Diffuseur opale satinée pour un éclairage général. Driver intégré dans le luminaire, au choix ON/OFF ou graduable (1-10V, DALI, Touch-Dim, Casambi). Température de couleur 2200K, 2700K, 3000K, 3500K, 4000K ou 6500K. Binning initial  $\leq$  MacAdam 3. Rendu de couleur CRI>80 ou CRI>90.

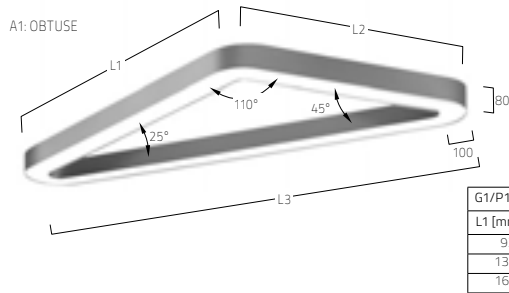

G1/P1: OBTUSE		
L1 [mm]	L2 [mm]	L3 [mm]
930	640	1140
1315	830	1630
1615	1025	2040

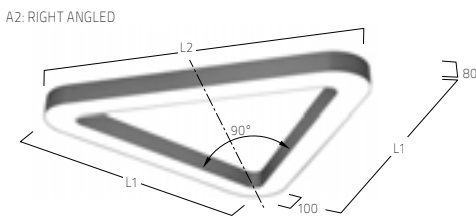

G2/P2: RIGHT ANGLED	
L1 [mm]	L2 [mm]
740	940
935	1215
1230	1625

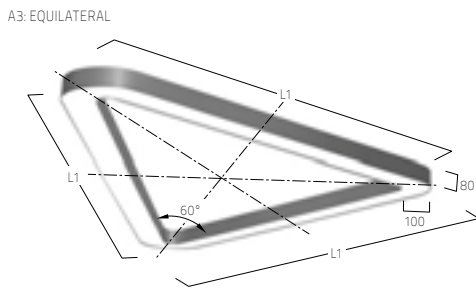

G3/P3: EQUILATERAL	
L1 [mm]	
840	
1130	
1420	

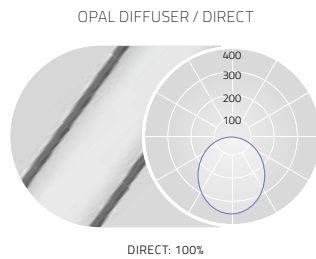
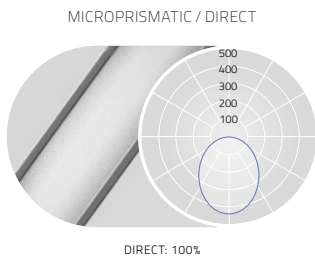

L1 mm	Lumenlm/Watt Medium Power	Lumenlm/Watt High Power
<b>A1: OBTUSE</b>		
930	6810lm/52W	9920lm/84W
1315	9810lm/74W	14290lm/121W
1615	12260lm/92W	17860lm/147W

L1 mm	Lumenlm/Watt Medium Power	Lumenlm/Watt High Power
<b>A1: OBTUSE</b>		
930	5870lm/52W	8550lm/84W
1315	8450lm/74W	12310lm/121W
1615	10570lm/92W	15390lm/147W

L1 mm	Lumenlm/Watt Medium Power	Lumenlm/Watt High Power
<b>A2: RIGHT ANGLED</b>		
740	5990lm/46W	8710lm/75W
935	7890lm/60W	11490lm/96W
1230	10620lm/80W	15460lm/130W

L1 mm	Lumenlm/Watt Medium Power	Lumenlm/Watt High Power
<b>A2: RIGHT ANGLED</b>		
740	5160lm/46W	7510lm/75W
935	6800lm/60W	9900lm/96W
1230	9150lm/80W	13320lm/130W

L1 mm	Lumenlm/Watt Medium Power	Lumenlm/Watt High Power
<b>A3: EQUILATERAL</b>		
840	6530lm/50W	9510lm/81W
1130	8980lm/68W	13080lm/107W
1420	11440lm/85W	16650lm/138W

L1 mm	Lumenlm/Watt Medium Power	Lumenlm/Watt High Power
<b>A3: EQUILATERAL</b>		
840	5630lm/50W	8190lm/81W
1130	7740lm/68W	11270lm/107W
1420	9860lm/85W	14350lm/138W

Lumen Values: Luminaire luminous flux at 4000K/CRI>80 / surface finished Snow White. Other configurations on request.

**PRODUCT-CODE:** Y A1 A S E - 8 30 M - L930

- PRODUCT FAMILY - Y: Three Peaks  
 TYPE - A1: Obtuse Direct  
 A2: Right Angled Direct  
 A3: Equilateral Direct  
 OPTICAL SYSTEM - O: Opal, A: Microprismatic  
 SURFACE FINISH - W: Snow White, S: Radiant Silver, U: Urban Graphite,  
 B: Jet Black, H: Champagne Silver, K: Satin Copper  
 CONTROL GEAR - E: On/Off, L: DALI, D: 1-10V, H: Touch-Dim, C: Casambi  
 COLOUR REND. - 8: CRI>80, 9: CRI>90, F: Full Spectrum  
 COLOUR TEMP. - 22: 2200K, 27: 2700K, 30: 3000K, 35: 3500K, 40: 4000K, 65: 6500K  
 POWER - M: Medium Power, H: High Power  
 SIZE - A1: Luminaire L1 length in mm: L930, L1315, L1615  
 A2: Luminaire L1 length in mm: L740, L935, L1230  
 A3: Luminaire L1 length in mm: L840, L1130, L1420  
 ON REQUEST - Emergency Module



CALEO INVERSE  
SURFACE | A3



**DE** LED-Anbauleuchte. Rein Direktstrahlend. Leuchtenkörper aus Aluminiumprofil. Oberfläche silber, weiß, graphit, schwarz, champagner oder kupferfarben lackiert. Weitere Oberflächenoptionen siehe Lightnet-Surface-Collection oder RAL nach Wahl. Opaldiffusor aus satiniertem Acrylglas für Allgemeinbeleuchtung. Konverter in Leuchtgehäuse integriert, wahlweise einfach schaltbar oder stufenlos dimmbar (1-10V, DALI, Touch-Dim, Casambi). Farbtemperaturen 2200K, 2700K, 3000K, 3500K, 4000K oder 6500K. Binning initial ≤ MacAdam 3. Farbwiedergabe CRI>80 oder CRI>90. Lieferung Leuchtgehäuse erfolgt als fertig montierbare Einheit für einfache Installation und durchgehend homogene Auflösung der Lichtpunkte.

**EN** LED surface-mounted luminaire. Direct only light distribution. Luminaire body made of aluminum profile. Surface silver, white, graphite, black, champagne or copper coated. Further surface options see Lightnet-Surface-Collection or RAL of your choice. Opal diffuser made of acrylic glass for general lighting. Converter integrated into luminaire housing, optionally switchable or dimmable (1-10V, DALI, Touch-Dim, Casambi). Colour temperatures 2200K, 2700K, 3000K, 3500K, 4000K or 6500K. Binning initial ≤ MacAdam 3. Colour rendering CRI>80 or CRI>90. The luminaire housing is supplied as a ready-to-mount unit for easy installation and uniform and enhanced light transmission.

**FR** Luminaire LED en saillie. Éclairage seulement direct. Corps du luminaire en profilé aluminium. Surface laquée argent, blanc, graphite, noir, champagne ou cuivre. Autres options de finition voir Lightnet-Surface-Collection ou RAL au choix. Diffuseur opale en verre acrylique pour éclairage général. Driver intégré dans le luminaire, au choix ON/OFF ou graduable (1-10V, DALI, Touch-Dim, Casambi). Température de couleur 2200K, 2700K, 3000K, 3500K, 4000K ou 6500K. Binning initial ≤ MacAdam 3. Rendu de couleur CRI>80 ou CRI>90. Le corps du luminaire est livré sous forme d'unité prête au montage pour une installation facile et une résolution homogène et continue des points lumineux.

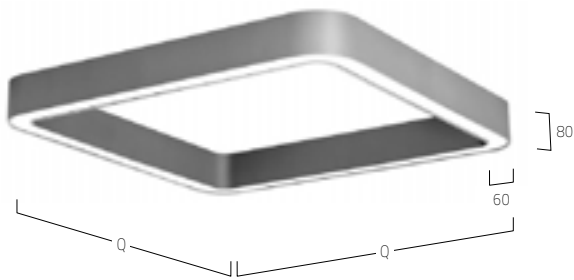

**PRODUCT-CODE:** A A3 O S E - 8 30 M - Q950

PRODUCT FAMILY	- A: Caleo
TYPE	- A3: Direct Only
OPTICAL SYSTEM	- O: Opal, A: Microprismatic
SURFACE FINISH	- W: Snow White, S: Radiant Silver, U: Urban Graphite, B: Jet Black, H: Champagne Silver, K: Satin Copper
CONTROL GEAR	- E: On/Off, L: DALI, D: 1-10V, H: Touch-Dim, C: Casambi
COLOUR REND.	- 8: CRI>80, 9: CRI>90, F: Full Spectrum
COLOUR TEMP.	- 22: 2200K, 27: 2700K, 30: 3000K, 35: 3500K, 40: 4000K, 65: 6500K, TW: Tunable White 2700-6500K
POWER	- M: Medium Power, H: High Power
SIZE	- Square Size in mm: Q950, Q1245, Q1530
ON REQUEST	- Emergency Module



MICROPRISMATIC / DIRECT

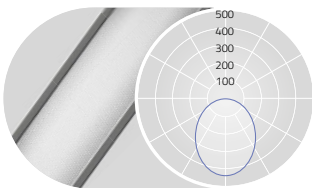

DIRECT: 100%

Q mm	Lumen/Watt Medium Power	Lumen/Watt High Power
950	5000lm/50W	7310lm/81W
1245	6670lm/66W	9750lm/104W
1530	8340lm/81W	12190lm/132W

OPAL DIFFUSER / DIRECT

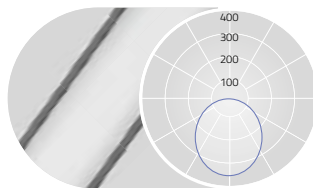

DIRECT: 100%

Q mm	Lumen/Watt Medium Power	Lumen/Watt High Power
950	4180lm/50W	6110lm/81W
1245	5570lm/66W	8150lm/104W
1530	6970lm/81W	10190lm/132W

Lumen Values: Luminaire luminous flux at 4000K/CRI>80 / surface finished Snow White. Other configurations on request.



CALEO LINEAR  
SURFACE | A3



**DE** LED-Anbauleuchte. Rein Direktstrahlend. Leuchtenkörper aus Aluminiumprofil. Oberfläche silber, weiß, graphit, schwarz, champagner oder kupferfarben lackiert. Weitere Oberflächenoptionen siehe Lightnet-Surface-Collection oder RAL nach Wahl. Microprismenoptik mit optimierter Blendungsbegrenzung speziell für Office-Anwendungen. Satinierter Opaldiffusor für Allgemeinbeleuchtung. Konverter in Leuchtengehäuse integriert, wahlweise einfach schaltbar oder stufenlos dimmbar (1-10V, DALI, Touch-Dim, Casambi). Farbtemperaturen 2200K, 2700K, 3000K, 3500K, 4000K oder 6500K. Binning initial  $\leq$  MacAdam 3. Farbwiedergabe CRI>80 oder CRI>90.

**EN** LED surface-mounted luminaire. Direct only light distribution. Luminaire body made of aluminum profile. Surface silver, white, graphite, black, champagne or copper coated. Further surface options see Lightnet-Surface-Collection or RAL of your choice. Microprismatic with optimized glare reduction especially for workplaces. Satin opal diffuser for general lighting. Converter integrated into luminaire housing, optionally switchable or dimmable (1-10V, DALI, Touch-Dim, Casambi). Colour temperatures 2200K, 2700K, 3000K, 3500K, 4000K or 6500K. Binning initial  $\leq$  MacAdam 3. Colour rendering CRI>80 or CRI>90.

**FR** Luminaire LED en saillie. Éclairage seulement direct. Corps du luminaire en profilé aluminium. Surface laquée argent, blanc, graphite, noir, champagne ou cuivre. Autres options de finition voir Lightnet-Surface-Collection ou RAL au choix. Diffuseur microprismatique optimisé pour un éblouissement limité et adapté aux bureaux. Diffuseur opale satinée pour un éclairage général. Driver intégré dans le luminaire, au choix ON/OFF ou graduable (1-10V, DALI, Touch-Dim, Casambi). Température de couleur 2200K, 2700K, 3000K, 3500K, 4000K ou 6500K. Binning initial  $\leq$  MacAdam 3. Rendu de couleur CRI>80 ou CRI>90.

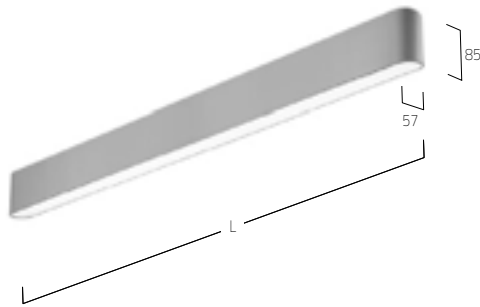

**PRODUCT-CODE:** A A3 O S E - 8 30 M - L894

PRODUCT FAMILY	- A Caleo
TYPE	- A3 Direct Only
OPTICAL SYSTEM	- O Opal, A Microprismatic
SURFACE FINISH	- W: Snow White, S: Radiant Silver, U: Urban Graphite, B: Jet Black, H: Champagne Silver, K: Satin Copper
CONTROL GEAR	- E: On/Off, L: DALI, D: 1-10V, H: Touch-Dim, C: Casambi
COLOUR REND.	- 8: CRI>80, 9: CRI>90, F: Full Spectrum
COLOUR TEMP.	- 22: 2200K, 27: 2700K, 30: 3000K, 35: 3500K, 40: 4000K, 65: 6500K, TW: Tunable White 2700-6500K [L894-L1475]
POWER	- M: Medium Power, H: High Power
SIZE	- Luminaire length in mm: L600, L894, L1182, L1475
ON REQUEST	- Emergency Module

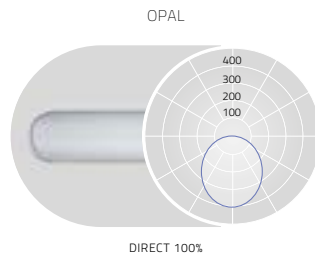
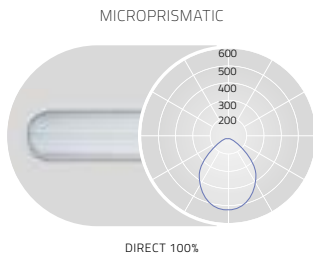

L mm	Lumen/Watt Medium Power	Lumen/Watt High Power
600	1250lm/13W	1810lm/19W
894	1870lm/19W	2720lm/28W
1182	2490lm/24W	3620lm/36W
1475	3110lm/29W	4530lm/44W

L mm	Lumen/Watt Medium Power	Lumen/Watt High Power
600	1390lm/13W	2010lm/19W
894	2080lm/19W	3020lm/28W
1182	2770lm/24W	4030lm/36W
1475	3470lm/29W	5040lm/44W

Lumen Values: Luminaire luminous flux at 4000K/CRI>80. Other configurations on request.

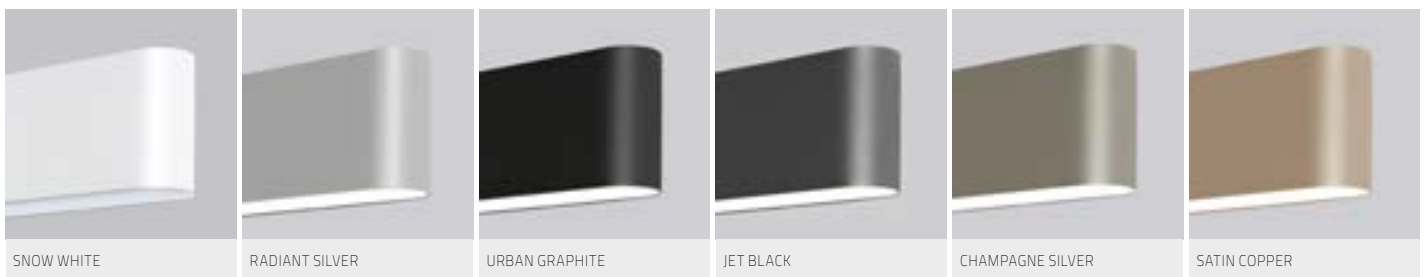



CALEO  
SURFACE | Y1/X1



**DE** LED-Anbauleuchte. Rein direkt oder Direkt-indirektstrahlend. Leuchtenkörper aus Aluminiumprofil. Oberfläche silber, weiß, graphit, schwarz, champagner oder kupferfarben lackiert. Weitere Oberflächenoptionen siehe Lightnet-Surface-Collection oder RAL nach Wahl. Microprismenoptik mit optimierter Blendungsbegrenzung speziell für Office-Anwendungen. Satinierter Opaldiffusor für Allgemeinbeleuchtung. Indirektanteil mit innovativer Linsentechnologie für breitstrahlende Deckenaufhellung. Konverter in Leuchtengehäuse integriert, wahlweise einfach schaltbar oder stufenlos dimmbar (1-10V, DALI, Touch-Dim, Casambi). Farbtemperaturen 2200K, 2700K, 3000K, 3500K, 4000K oder 6500K. Binning initial  $\leq$  MacAdam 3. Farbwiedergabe CRI>80 oder CRI>90. Auf Anfrage: Integration von Notlichtkomponenten.

**EN** LED surface-mounted luminaire. Direct only or direct-indirect light distribution. Luminaire body made of aluminum profile. Surface silver, white, graphite, black, champagne or copper coated. Further surface options see Lightnet-Surface-Collection or RAL of your choice. Microprismatic with optimized glare reduction especially for workplaces. Satin opal diffuser for general lighting. Indirect light with innovative lens technology for wide-angle ceiling illumination. Converter integrated into luminaire housing, optionally switchable or dimmable (1-10V, DALI, Touch-Dim, Casambi). Colour temperatures 2200K, 2700K, 3000K, 3500K, 4000K or 6500K. Binning initial  $\leq$  MacAdam 3. Colour rendering CRI>80 or CRI>90. On request: Integration of emergency lighting components.

**FR** Luminaire LED en saillie. Éclairage uniquement direct ou direct/indirect. Corps du luminaire en profilé aluminium. Surface laquée argent, blanc, graphite, noir, champagne ou cuivre. Autres options de finition voir Lightnet-Surface-Collection ou RAL au choix. Diffuseur microprismatique optimisé pour un éblouissement limité et adapté aux bureaux. Diffuseur opale satinée pour un éclairage général. Composants indirects avec une technologie de lentille innovante pour un éclairage grand angle du plafond. Driver intégré dans le luminaire, au choix ON/OFF ou graduable (1-10V, DALI, Touch-Dim, Casambi). Température de couleur 2200K, 2700K, 3000K, 3500K, 4000K ou 6500K. Binning initial  $\leq$  MacAdam 3. Rendu de couleur CRI>80 ou CRI>90. Sur demande: Intégration de composants d'éclairage de secours.

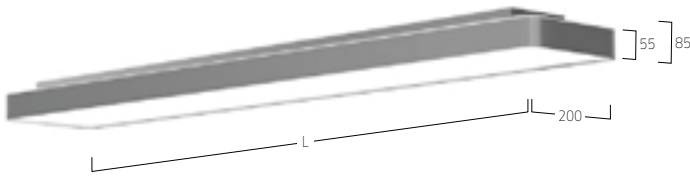

**PRODUCT-CODE: A X1 O S E - 8 30 M - L900**

PRODUCT FAMILY	- A: Caleo
TYPE	- X1: Direct-Indirect, Y1: Direct Only
OPTICAL SYSTEM	- O: Opal, A: Microprismatic
SURFACE FINISH	- W: Snow White, S: Radiant Silver, U: Urban Graphite, B: Jet Black, H: Champagne Silver, K: Satin Copper
CONTROL GEAR	- E: On/Off, L: DALI, D: 1-10V, H: Touch-Dim, C: Casambi
COLOUR REND.	- 8: CRI>80, 9: CRI>90
COLOUR TEMP.	- 22: 2200K, 27: 2700K, 30: 3000K, 35: 3500K, 40: 4000K, 65: 6500K, TW: Tunable White 2700-6500K
POWER	- M: Medium Power, H: High Power
SIZE	- Luminaire length in mm: L900, L1200, L1500
ON REQUEST	- Emergency Module



MICROPRISMATIC / DIRECT-INDIRECT



UGR $\leq$ 19 (X=4H, Y=8H, S=0.25H)  
DIRECT: ca. 65% INDIRECT ca. 35%

L mm	Lumen/Watt Medium Power	Lumen/Watt High Power
900	3470lm/30W	4920lm/42W
1200	4620lm/38W	6560lm/55W
1500	5780lm/46W	8210lm/67W

MICROPRISMATIC / DIRECT

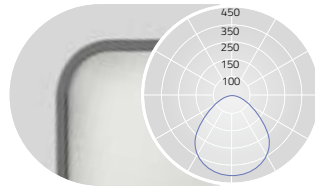

UGR $\leq$ 19 for Medium Power (X=4H, Y=8H, S=0.25H)  
DIRECT: 100%

L mm	Lumen/Watt Medium Power	Lumen/Watt High Power
900	2170lm/18W	3320lm/27W
1200	2890lm/23W	4430lm/36W
1500	3610lm/28W	5540lm/44W

OPAL DIFFUSER / DIRECT-INDIRECT

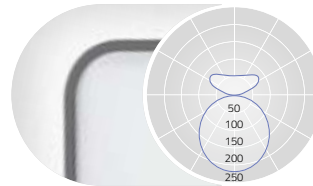

DIRECT: ca. 65% INDIRECT ca. 35%

L mm	Lumen/Watt Medium Power	Lumen/Watt High Power
900	3560lm/30W	5090lm/42W
1200	4750lm/38W	6780lm/55W
1500	5940lm/46W	8480lm/67W

OPAL DIFFUSER / DIRECT

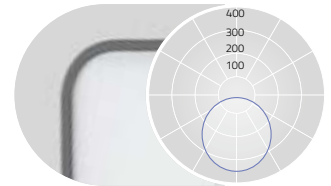

DIRECT: 100%

L mm	Lumen/Watt Medium Power	Lumen/Watt High Power
900	2260lm/18W	3490lm/27W
1200	3020lm/23W	4650lm/36W
1500	3770lm/28W	5810lm/44W

Lumen Values: Luminaire luminous flux at 4000K/CRI>80. Other configurations on request.

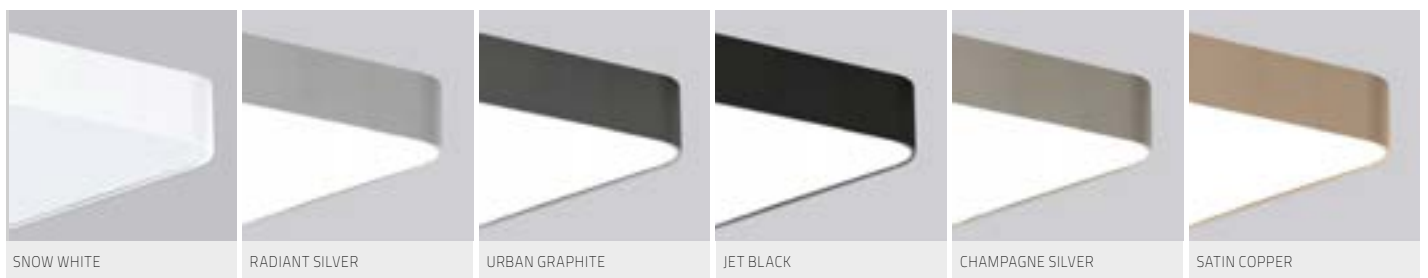

CALEO  
SURFACE | A2



**DE** LED-Anbauleuchte für Wand- oder Deckenmontage. Rein Direktstrahlend. Leuchtenkörper aus Aluminiumprofil. Oberfläche silber, weiß, graphit, schwarz, champagner oder kupferfarben lackiert. Weitere Oberflächenoptionen siehe Lightnet-Surface-Collection oder RAL nach Wahl. Microprismenoptik mit optimierter Blendungsbegrenzung speziell für Office-Anwendungen. Konverter in Leuchtgehäuse integriert, wahlweise einfach schaltbar oder stufenlos dimmbar (1-10V, DALI, Touch-Dim, Casambi). Farbtemperaturen 2200K, 2700K, 3000K, 3500K, 4000K oder 6500K. Binning initial ≤ MacAdam 3. Farbwiedergabe CRI>80 oder CRI>90. Auf Anfrage: Integration von Notlichtkomponenten.

**EN** LED surface-mounted luminaire for walls or ceilings. Direct only light distribution. Luminaire body made of aluminum profile. Surface silver, white, graphite, black, champagne or copper coated. Further surface options see Lightnet-Surface-Collection or RAL of your choice. Microprismatic with optimized glare reduction especially for workplaces. Satin opal diffuser for general lighting. Driver integrated into luminaire housing, optionally switchable or dimmable (1-10V, DALI, Touch-Dim, Casambi). Colour temperatures 2200K, 2700K, 3000K, 3500K, 4000K or 6500K. Binning initial ≤ MacAdam 3. Colour rendering CRI>80 or CRI>90. On request: Integration of emergency lighting components.

**FR** Luminaire LED en saillie pour murs et plafonds. Éclairage seulement direct. Corps du luminaire en profilé aluminium. Surface laquée argent, blanc, graphite, noir, champagne ou cuivre. Autres options de finition voir Lightnet-Surface-Collection ou RAL au choix. Diffuseur microprismatique optimisé pour un éblouissement limité et adapté aux bureaux. Diffuseur opale satinée pour un éclairage général. Driver intégré dans le luminaire, au choix ON/OFF ou graduable (1-10V, DALI, Touch-Dim, Casambi). Température de couleur 2200K, 2700K, 3000K, 3500K, 4000K ou 6500K. Binning initial ≤ MacAdam 3. Rendu de couleur CRI>80 ou CRI>90. Sur demande: Intégration de composants d'éclairage de secours.

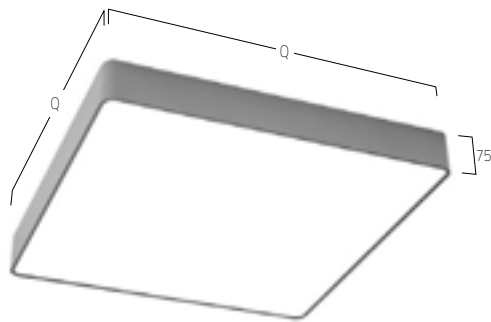

**PRODUCT-CODE:** **A A2 O S E - 8 30 M - Q430**

PRODUCT FAMILY	- A Caleo
TYPE	- A2 Direct Only
OPTICAL SYSTEM	- O Opal, A Microprismatic
SURFACE FINISH	- W: Snow White, S: Radiant Silver, U: Urban Graphite, B: Jet Black, H: Champagne Silver, K: Satin Copper
CONTROL GEAR	- E: On/Off, L: DALI, D: 1-10V, H: Touch-Dim, C: Casambi
COLOUR REND.	- 8: CRI>80, 9: CRI>90, F: Full Spectrum
COLOUR TEMP.	- 22: 2200K, 27: 2700K, 30: 3000K, 35: 3500K, 40: 4000K, 65: 6500K, TW: Tunable White 2700-6500K
POWER	- M: Medium Power, H: High Power
SIZE	- Square Size in mm: Q330, Q430, Q530, Q630, Q900
ON REQUEST	- Emergency Module, Radar Sensor



MICROPRISMATIC / DIRECT

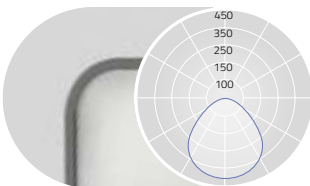

UGR≤19 for Medium Power (X=4H, Y=8H, S=0.25H)  
DIRECT: 100%

OPAL DIFFUSER / DIRECT

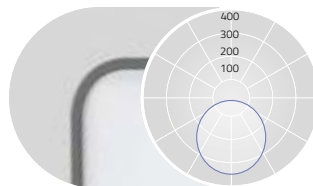

DIRECT: 100%

Q mm	Lumen/Watt Medium Power	Lumen/Watt High Power
330	1360lm/12W	2010lm/18W
430	2370lm/20W	3450lm/29W
530	3630lm/27W	6790lm/51W
630	5200lm/40W	8500lm/65W
900	7910lm/67W	13240lm/129W

Q mm	Lumen/Watt Medium Power	Lumen/Watt High Power
330	1400lm/12W	2070lm/18W
430	2440lm/20W	3550lm/29W
530	3740lm/27W	6990lm/51W
630	5360lm/40W	8760lm/65W
900	8150lm/67W	13640lm/129W

Lumen Values: Luminaire luminous flux at 4000K/CRI>80 / surface finished Snow White. Other configurations on request.



CALEO  
SURFACE | Y2/X2



**DE** LED-Anbauleuchte für Wand- oder Deckenmontage. Direkt-indirektstrahlend oder rein direktstrahlend. Leuchtenkörper aus Aluminiumprofil. Oberfläche silber, weiß, graphit, schwarz, champagner oder kupferfarben lackiert. Weitere Oberflächenoptionen siehe Lightnet-Surface-Collection oder RAL nach Wahl. Microprismenoptik mit optimierter Blendungsbegrenzung speziell für Office-Anwendungen. Satinierter Opaldiffusor für Allgemeinbeleuchtung. Konverter in Leuchtgehäuse integriert, wahlweise einfach schaltbar oder stufenlos dimmbar (1-10V, DALI, Touch-Dim, Casambi). Farbtemperaturen 2200K, 2700K, 3000K, 3500K, 4000K oder 6500K. Binning initial ≤ MacAdam 3. Farbwiedergabe CRI>80 oder CRI>90. Auf Anfrage: Integration von Notlichtkomponenten.

**EN** LED surface-mounted luminaire for walls or ceilings. Direct-indirect or Direct Only light distribution. Luminaire body made of aluminum profile. Surface silver, white, graphite, black, champagne or copper coated. Further surface options see Lightnet-Surface-Collection or RAL of your choice. Microprismatic with optimized glare reduction especially for workplaces. Satin opal diffuser for general lighting. Converter integrated into luminaire housing, optionally switchable or dimmable (1-10V, DALI, Touch-Dim, Casambi). Colour temperatures 2200K, 2700K, 3000K, 3500K, 4000K or 6500K. Binning initial ≤ MacAdam 3. Colour rendering CRI>80 or CRI>90. On request: Integration of emergency lighting components.

**FR** Luminaire LED en saillie pour murs et plafonds. Éclairage seulement direct. Corps du luminaire en profilé aluminium. Surface laquée argent, blanc, graphite, noir, champagne ou cuivre. Autres options de finition voir Lightnet-Surface-Collection ou RAL au choix. Diffuseur microprismatique optimisé pour un éblouissement limité et adapté aux bureaux. Diffuseur opale satinée pour un éclairage général. Driver intégré dans le luminaire, au choix ON/OFF ou graduable (1-10V, DALI, Touch-Dim, Casambi). Température de couleur 2200K, 2700K, 3000K, 3500K, 4000K ou 6500K. Binning initial ≤ MacAdam 3. Rendu de couleur CRI>80 ou CRI>90. Sur demande: Intégration de composants d'éclairage de secours.

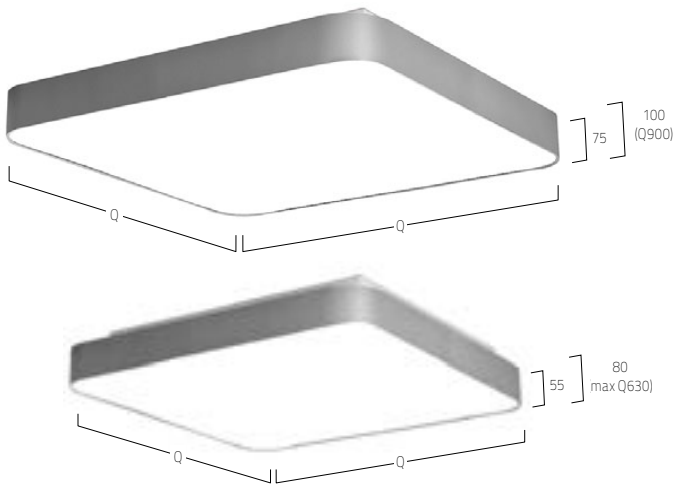

**PRODUCT-CODE:** A X2 O S E - 8 30 M - Q430

PRODUCT FAMILY	- A Caleo
TYPE	- X2 Direct-Indirect, Y2 Direct Only
OPTICAL SYSTEM	- O Opal, A Microprismatic
SURFACE FINISH	- W Snow White, S Radiant Silver, U Urban Graphite, B Jet Black, H Champagne Silver, K Satin Copper
CONTROL GEAR	- E On/Off, L DALI, D 1-10V, H Touch-Dim, C Casambi
COLOUR REND.	- 8 CRI>80, 9 CRI>90, F Full Spectrum
COLOUR TEMP.	- 22 2200K, 27 2700K, 30 3000K, 35 3500K, 40 4000K, 65 6500K, TW Tunable White 2700-6500K [Q430-Q900]
POWER	- M Medium Power, H High Power
SIZE	- Square Size in mm: Q330, Q430, Q530, Q630, Q900
ON REQUEST	- Emergency Module, Radar Sensor

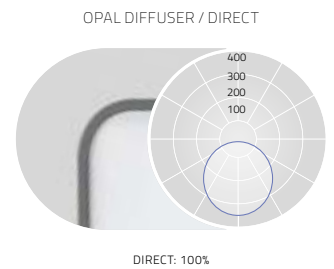
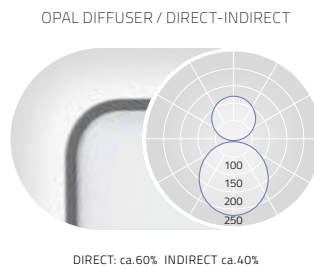
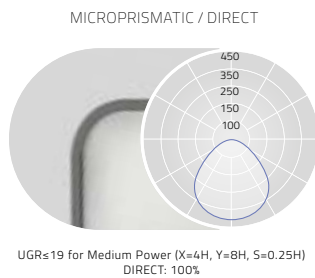
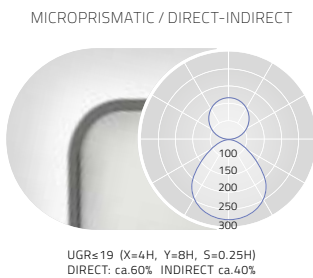

Q mm	Lumen/Watt Medium Power	Lumen/Watt High Power
330	2470lm/19W	3640lm/28W
430	4360lm/31W	6300lm/45W
530	6000lm/40W	11170lm/80W
630	9610lm/68W	14270lm/103W
900	11790lm/96W	19040lm/173W

Q mm	Lumen/Watt Medium Power	Lumen/Watt High Power
330	1360lm/12W	2010lm/18W
430	2370lm/20W	3450lm/29W
530	3630lm/27W	6790lm/51W
630	5200lm/40W	8500lm/65W
900	7910lm/67W	13240lm/129W

Q mm	Lumen/Watt Medium Power	Lumen/Watt High Power
330	2510lm/19W	3700lm/28W
430	4430lm/31W	6400lm/45W
530	6110lm/40W	11370lm/80W
630	9770lm/68W	14530lm/103W
900	12030lm/96W	19440lm/173W

Q mm	Lumen/Watt Medium Power	Lumen/Watt High Power
330	1400lm/12W	2070lm/18W
430	2440lm/20W	3550lm/29W
530	3740lm/27W	6990lm/51W
630	5360lm/40W	8760lm/65W
900	8150lm/67W	13640lm/129W

Lumen Values: Luminaire luminous flux at 4000K/CRI>80 / surface finished Snow White. Other configurations on request.



CUBIC EVOLUTION  
SURFACE | Y4/X4



**DE** LED-Anbauleuchte für Wand- oder Deckenmontage. Direktstrahlend mit indirekter Lichtkorona oder rein direktstrahlend. Gestufter Leuchtenkörper aus Aluminiumprofil mit lediglich 25mm sichtbarem Rahmenprofil. Oberfläche natureloxiert oder weiß, graphit, schwarz bzw. champagnerfarben lackiert sowie Alu poliert. Weitere Oberflächenoptionen siehe Lightnet-Surface-Collection oder RAL nach Wahl. Microprismenoptik mit optimierter Blendungsbegrenzung speziell für Office-Anwendungen. Satinierter Opaldiffusor für Allgemeinbeleuchtung mit max. Transmissionsgrad und homogener Lichtpunktauflösung. Indirekanteil mit innovativer Linsentechnologie für breitstrahlende Deckenaufhellung. Konverter in Leuchtgehäuse integriert, wahlweise einfach schaltbar oder stufenlos dimmbar (1-10V, DALI, Touch-Dim, Casambi). Farbtemperaturen 2700K, 3000K, 3500K oder 4000K. Binning initial ≤ MacAdam 3. Farbwiedergabe CRI>80 oder CRI>90. Durchdachtes Montagesystem für einfache Installation und stabilen Halt. Auf Anfrage: Integration von Notlichtkomponenten, Sensortechnologie.

**EN** LED surface-mounted luminaire for walls or ceilings. Direct light distribution and indirect lighting corona or direct only light distribution. Tiered luminaire body made of aluminium profile with only 25mm visible frame. Surface natural anodised or white, graphite, black or champagne coated as well as polished aluminium. Further surface options see Lightnet-Surface-Collection or RAL of your choice. Microprismatic with optimized glare reduction especially for workplaces. Satin opal diffuser for general lighting with maximum transmittance and homogeneous lighting. Indirect light with innovative lens technology for wide-angle ceiling illumination. Driver integrated into luminaire housing, optionally switchable or dimmable (1-10V, DALI, Touch-Dim, Casambi). Colour temperature 2700K, 3000K, 3500K or 4000K. Binning initial ≤ MacAdam 3. Colour rendering CRI>80 or CRI>90. Sophisticated mounting system for easy installation and stable hold. On request: Integration of emergency lighting components, sensor technology.

**FR** Luminaire LED en saillie pour murs et plafonds. Éclairage direct avec colerette de lumière indirecte ou uniquement éclairage direct. Corps du luminaire étagé en profilé aluminium avec cadre visible de seulement 25mm. Surface anodisée ou laquée blanc, graphite, noir, champagne ou polie. Autres options de finition voir Lightnet-Surface-Collection ou RAL au choix. Diffuseur microprismatique optimisé pour un éblouissement limité et adapté aux bureaux. Diffuseur opale satiné pour un éclairage général et une transmission maximale et homogène. Composants indirects avec une technologie de lentille innovante pour un éclairage grand angle du plafond. Driver intégré dans le luminaire, au choix ON/OFF ou graduable (1-10V, DALI, Touch-Dim, Casambi). Température de couleur 2700K, 3000K, 3500K ou 4000K. Binning initial ≤ MacAdam 3. Rendu de couleur CRI>80 ou CRI>90. Système de montage sophistiqué pour une installation facile et stable. Sur demande: Intégration de composants d'éclairage de secours ou de capteurs.

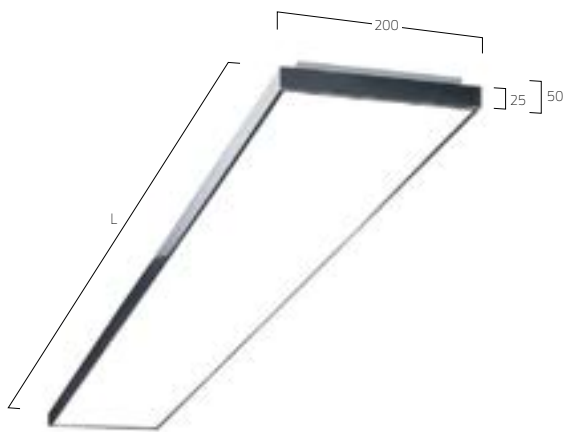

**PRODUCT-CODE:** C X4 A B E - 8 30 M - L900

PRODUCT FAMILY	- C: Cubic
TYPE	- X4: Surface Direct-Indirect
	- Y4: Surface Direct Only
OPTICAL SYSTEM	- A: Microprismatic, O: Opal Diffuser
SURFACE FINISH	- W: Snow White, E: Silver Anodised, U: Urban Graphite,
	- B: Jet Black, H: Champagne Silver, P: Polished Aluminum
	- C: Casambi
CONTROL GEAR	- E: On/Off, L: DALI, D: 1-10V, H: Touch-Dim, C: Casambi
COLOUR REND.	- 8: CRI>80, 9: CRI>90
COLOUR TEMP.	- 27: 2700K, 30: 3000K, 35: 3500K, 40: 4000K, TW: Tunable White 2700-6500K
POWER	- M: Medium Power, H: High Power
SIZE	- Luminaire Length in mm L900, L1200, L1500
ON REQUEST	- Emergency Module, Multisensor, Radar Sensor

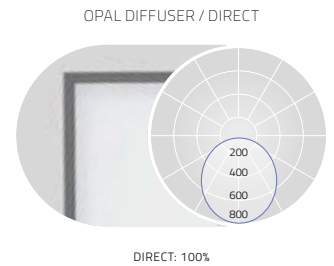
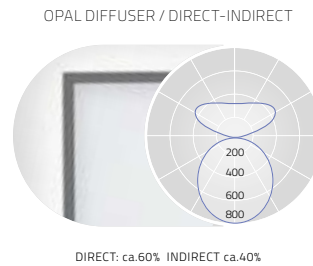
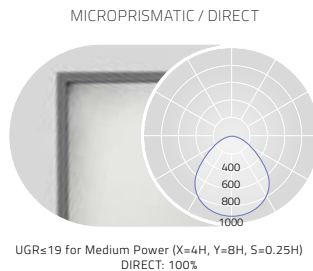
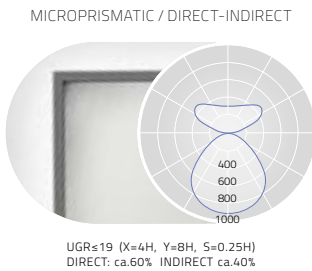

L mm	Lumen/Watt Medium Power	Lumen/Watt High Power
900	3990lm/33W	5010lm/42W
1200	5170lm/43W	6490lm/55W
1500	6400lm/53W	8000lm/68W

L mm	Lumen/Watt Medium Power	Lumen/Watt High Power
900	2330lm/19W	2990lm/26W
1200	2960lm/26W	3800lm/33W
1500	3640lm/32W	4630lm/41W

L mm	Lumen/Watt Medium Power	Lumen/Watt High Power
900	3780lm/33W	4730lm/42W
1200	5000lm/43W	6240lm/55W
1500	6110lm/53W	7630lm/68W

L mm	Lumen/Watt Medium Power	Lumen/Watt High Power
900	2120lm/19W	2710lm/26W
1200	2790lm/26W	3550lm/33W
1500	3350lm/32W	4260lm/41W

Lumen Values: Luminaire luminous flux at 4000K/CRI>80. Other configurations on request.





# CUBIC EVOLUTION SURFACE | Y5/X5



**DE** LED-Anbauleuchte für Wand- oder Deckenmontage. Direktstrahlend mit indirekter Lichtkorona oder rein direktstrahlend. Gestufter Leuchtenkörper aus Aluminiumprofil mit lediglich 25mm sichtbarem Rahmenprofil. Oberfläche natureloxiert oder weiß, graphit, schwarz bzw. champagnerfarben lackiert sowie Alu poliert. Weitere Oberflächenoptionen siehe Lightnet-Surface-Collection oder RAL nach Wahl. Microprismenoptik mit optimierter Blendungsbegrenzung speziell für Office-Anwendungen. Satinierter Opaldiffusor für Allgemeinbeleuchtung mit max. Transmissionsgrad und homogener Lichtpunktauflösung. Indirektanteil mit innovativer Linsentechnologie für breitstrahlende Deckenaufhellung. Konverter in Leuchtgehäuse integriert, wahlweise einfach schaltbar oder stufenlos dimmbar (1-10V, DALI, Touch-Dim, Casambi). Farbtemperaturen 2700K, 3000K, 3500K oder 4000K. Binning initial  $\leq$  MacAdam 3. Farbwiedergabe CRI>80 oder CRI>90. Durchdachtes Montagesystem für einfache Installation und stabilen Halt. Auf Anfrage: Integration von Notlichtkomponenten, Sensortechnologie.

**EN** LED surface-mounted luminaire for walls or ceilings. Direct light distribution and indirect lighting corona or direct only light distribution. Tiered luminaire body made of aluminium profile with only 25mm visible frame. Surface natural anodised or white, graphite, black or champagne coated as well as polished aluminium. Further surface options see Lightnet-Surface-Collection or RAL of your choice. Microprismatic with optimized glare reduction especially for workplaces. Satin opal diffuser for general lighting with maximum transmittance and homogeneous lighting. Indirect light with innovative lens technology for wide-angle ceiling illumination. Converter integrated into luminaire housing, optionally switchable or dimmable (1-10V, DALI, Touch-Dim, Casambi). Colour temperature 2700K, 3000K, 3500K or 4000K. Binning initial  $\leq$  MacAdam 3. Colour rendering CRI>80 or CRI>90. Sophisticated mounting system for easy installation and stable hold. On request: Integration of emergency lighting components, sensor technology.

**FR** Luminaire LED en saillie pour murs et plafonds. Éclairage direct avec colerette de lumière indirecte ou uniquement éclairage direct. Corps du luminaire étagé en profilé aluminium avec cadre visible de seulement 25mm. Surface anodisée ou laquée blanc, graphite, noir, champagne ou polie. Autres options de finition voir Lightnet-Surface-Collection ou RAL au choix. Diffuseur microprismatique optimisé pour un éblouissement limité et adapté aux bureaux. Diffuseur opale satiné pour un éclairage général et une transmission maximale et homogène. Composants indirects avec une technologie de lentille innovante pour un éclairage grand angle du plafond. Driver intégré dans le luminaire, au choix ON/OFF ou graduable (1-10V, DALI, Touch-Dim, Casambi). Température de couleur 2700K, 3000K, 3500K ou 4000K. Binning initial  $\leq$  MacAdam 3. Rendu de couleur CRI>80 ou CRI>90. Système de montage sophistiqué pour une installation facile et stable. Sur demande: Intégration de composants d'éclairage de secours ou de capteurs.

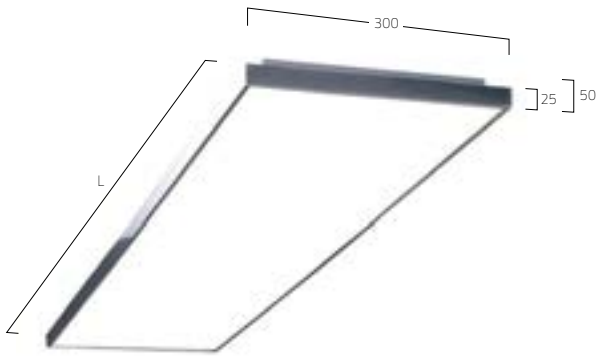

**PRODUCT-CODE:** C X5 A B E - 8 30 M - L900

PRODUCT FAMILY	- C: Cubic
TYPE	- X5: Surface Direct-Indirect
	- Y5: Surface Direct Only
OPTICAL SYSTEM	- A: Microprismatic, O: Opal Diffuser
SURFACE FINISH	- W: Snow White, E: Silver Anodised, U: Urban Graphite,
	- B: Jet Black, H: Champagne Silver, P: Polished Aluminium
CONTROL GEAR	- E: On/Off, L: DALI, D: 1-10V, H: Touch-Dim,
	- C: Casambi, M: Multisensor
COLOUR REND.	- 8: CRI>80, 9: CRI>90
COLOUR TEMP.	- 27: 2700K, 30: 3000K, 35: 3500K, 40: 4000K, TW: Tunable White 2700-6500K
POWER	- M: Medium Power, H: High Power
SIZE	- Luminaire Length in mm: L900, L1200, L1500
ON REQUEST	- Emergency Module, Radar Sensor



MICROPRISMATIC / DIRECT-INDIRECT		MICROPRISMATIC / DIRECT		OPAL DIFFUSER / DIRECT-INDIRECT		OPAL DIFFUSER / DIRECT		
UGR $\leq$ 19 (X=4H, Y=8H, S=0.25H) DIRECT: ca.60% INDIRECT ca.40%	UGR $\leq$ 19 for Medium Power (X=4H, Y=8H, S=0.25H) DIRECT: 100%	DIRECT: ca.60% INDIRECT ca.40%	DIRECT: 100%					
L mm	Lumen/Watt Medium Power	Lumen/Watt High Power	L mm	Lumen/Watt Medium Power	Lumen/Watt High Power	L mm	Lumen/Watt Medium Power	Lumen/Watt High Power
900	4950lm/41W	6700lm/56W	900	3230lm/26W	4610lm/37W	900	4670lm/41W	6290lm/56W
1200	6750lm/53W	9110lm/73W	1200	4460lm/33W	6320lm/48W	1200	6650lm/53W	8980lm/73W
1500	8540lm/65W	11580lm/90W	1500	5680lm/41W	8090lm/59W	1500	8120lm/65W	10970lm/90W

Lumen Values: Luminaire luminous flux at 4000K/CRI>80. Other configurations on request.



CUBIC EVOLUTION  
SURFACE | Y6/X6



**DE** LED-Anbauleuchte für Wand- oder Deckenmontage. Direktstrahlend mit indirekter Lichtkorona oder rein direktstrahlend. Gestufter Leuchtenkörper aus Aluminiumprofil mit lediglich 25mm sichtbarem Rahmenprofil. Oberfläche natureloxiert oder weiß, graphit, schwarz bzw. champagnerfarben lackiert sowie Alu poliert. Weitere Oberflächenoptionen siehe Lightnet-Surface-Collection oder RAL nach Wahl. Microprismenoptik mit optimierter Blendungsbegrenzung speziell für Office-Anwendungen. Satinierter Opaldiffusor für Allgemeinbeleuchtung mit max. Transmissionsgrad und homogener Lichtpunktauflösung. Indirektanteil mit innovativer Linsentechnologie für breitstrahlende Deckenaufhellung. Konverter in Leuchtengehäuse integriert, wahlweise einfach schaltbar oder stufenlos dimmbar (1-10V, DALI, Touch-Dim, Casambi). Farbtemperaturen 2700K, 3000K, 3500K oder 4000K. Binning initial  $\leq$  MacAdam 3. Farbwiedergabe CRI>80 oder CRI>90. Durchdachtes Montagesystem für einfache Installation und stabilen Halt. Auf Anfrage: Integration von Notlichtkomponenten, Sensortechnologie.

**EN** LED surface-mounted luminaire for walls or ceilings. Direct light distribution and indirect lighting corona or direct only light distribution. Tiered luminaire body made of aluminium profile with only 25mm visible frame. Surface natural anodised or white, graphite, black or champagne coated as well as polished aluminium. Further surface options see Lightnet-Surface-Collection or RAL of your choice. Microprismatic with optimized glare reduction especially for workplaces. Satin opal diffuser for general lighting with maximum transmittance and homogeneous lighting. Indirect light with innovative lens technology for wide-angle ceiling illumination. Driver integrated into luminaire housing, optionally switchable or dimmable (1-10V, DALI, Touch-Dim, Casambi). Colour temperature 2700K, 3000K, 3500K or 4000K. Binning initial  $\leq$  MacAdam 3. Colour rendering CRI>80 or CRI>90. Sophisticated mounting system for easy installation and stable hold. On request: Integration of emergency lighting components, sensor technology.

**FR** Luminaire LED en saillie pour murs et plafonds. Éclairage direct avec colerette de lumière indirecte ou uniquement éclairage direct. Corps du luminaire étagé en profilé aluminium avec cadre visible de seulement 25mm. Surface anodisée ou laquée blanc, graphite, noir, champagne ou polie. Autres options de finition voir Lightnet-Surface-Collection ou RAL au choix. Diffuseur microprismatique optimisé pour un éblouissement limité et adapté aux bureaux. Diffuseur opale satiné pour un éclairage général et une transmission maximale et homogène. Composants indirects avec une technologie de lentille innovante pour un éclairage grand angle du plafond. Driver intégré dans le luminaire, au choix ON/OFF ou graduable (1-10V, DALI, Touch-Dim, Casambi). Température de couleur 2700K, 3000K, 3500K ou 4000K. Binning initial  $\leq$  MacAdam 3. Rendu de couleur CRI>80 ou CRI>90. Système de montage sophistiqué pour une installation facile et stable. Sur demande: Intégration de composants d'éclairage de secours ou de capteurs.

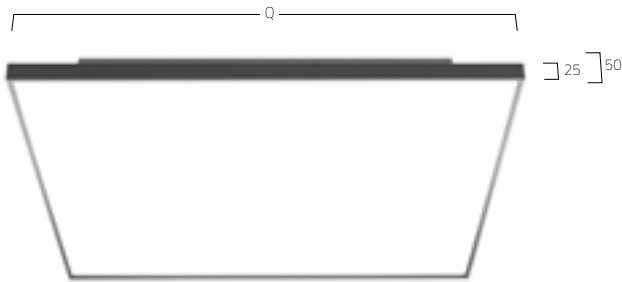

**PRODUCT-CODE:** C X6 A B E - 8 30 M - Q600

- PRODUCT FAMILY – C: Cubic
- TYPE – X6: Surface Direct-Indirect  
Y6: Surface Direct Only
- OPTICAL SYSTEM – A: Microprismatic, O: Opal Diffuser
- SURFACE FINISH – W: Snow White, E: Silver Anodised, U: Urban Graphite, B: Jet Black, H: Champagne Silver, P: Polished Aluminium
- CONTROL GEAR – E: On/Off, L: DALI, D: 1-10V, H: Touch-Dim, C: Casambi
- COLOUR REND. – 8: CRI>80, 9: CRI>90
- COLOUR TEMP. – 27: 2700K, 30: 3000K, 35: 3500K, 40: 4000K, TW: Tunable White 2700-6500K [Q400-Q600]
- POWER – M: Medium Power, H: High Power
- SIZE – Square Size in mm: Q300, Q400, Q500, Q600
- ON REQUEST – Emergency Module, Multisensor, Radar Sensor



MICROPRISMATIC / DIRECT-INDIRECT

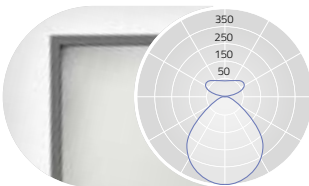

UGR $\leq$ 19 (X=4H, Y=8H, S=0.25H)  
DIRECT: ca.60% INDIRECT ca.40%

L mm	Lumen/Watt Medium Power	Lumen/Watt High Power
300	1600lm/13W	2360lm/20W
400	2590lm/19W	3570lm/27W
500	4490lm/33W	5860lm/44W
600	6670lm/46W	9240lm/66W

MICROPRISMATIC / DIRECT

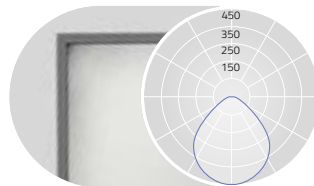

UGR $\leq$ 19 for Medium Power (X=4H, Y=8H, S=0.25H)  
DIRECT: 100%

L mm	Lumen/Watt Medium Power	Lumen/Watt High Power
300	1250lm/11W	1820lm/16W
400	2150lm/16W	2950lm/24W
500	3330lm/26W	4350lm/34W
600	4810lm/35W	6630lm/50W

OPAL DIFFUSER / DIRECT-INDIRECT



DIRECT: ca.70% INDIRECT ca.30%

L mm	Lumen/Watt Medium Power	Lumen/Watt High Power
300	1560lm/13W	2300lm/20W
400	2560lm/19W	3530lm/27W
500	4450lm/33W	5800lm/44W
600	6610lm/46W	9110lm/66W

OPAL DIFFUSER / DIRECT

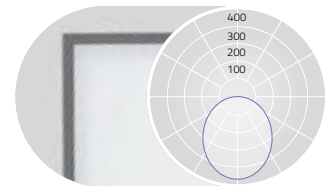

DIRECT 100%

L mm	Lumen/Watt Medium Power	Lumen/Watt High Power
300	1210lm/11W	1760lm/16W
400	2120lm/16W	2910lm/24W
500	3290lm/26W	4290lm/34W
600	4750lm/35W	6500lm/50W

Lumen Values: Luminaire luminous flux at 4000K/CRI>80. Other configurations on request.



MULTISENSOR CONTROL

EMERGENCY MODULE



SNOW WHITE

SILVER ANODISED

URBAN GRAPHITE

JET BLACK

CHAMPAGNE SILVER

POLISHED ALUMINIUM

CUBIC MAX  
SURFACE | A2



**DE** LED-Anbauleuchte für Wand- oder Deckenmontage. Rein direktstrahlend. Leuchtenkörper aus Aluminiumprofil. Oberfläche naturel oxidiert oder weiß, graphit, schwarz bzw. champagnerfarben lackiert sowie Alu poliert. Weitere Oberflächenoptionen siehe Lightnet-Surface-Collection oder RAL nach Wahl. Microprismenoptik mit optimierter Blendungsbegrenzung speziell für Office-Anwendungen. Satinierter Opaldiffusor für Allgemeinbeleuchtung mit max. Transmissionsgrad und homogener Lichtpunktauflösung. Konverter in Leuchtgehäuse integriert, wahlweise einfach schaltbar oder stufenlos dimmbar (1-10V, DALI, Touch-Dim, Casambi). Farbtemperaturen 2700K, 3000K, 3500K oder 4000K. Binning initial ≤ MacAdam 3. Farbwiedergabe CRI>80 oder CRI>90. Durchdachtes Montagesystem für einfache Installation und stabilen Halt. Auf Anfrage: Integration von Notlichtkomponenten, Sensortechnologie.

**EN** LED surface-mounted luminaire for walls or ceilings. Direct only light distribution. Luminaire body made of aluminum profile. Surface natural anodised or white, graphite, black or champagne coated as well as polished aluminium. Further surface options see Lightnet-Surface-Collection or RAL of your choice. Microprismatic with optimized glare reduction especially for workplaces. Satin opal diffuser for general lighting with maximum transmittance and homogeneous lighting. Converter integrated into luminaire housing, optionally switchable or dimmable (1-10V, DALI, Touch-Dim, Casambi). Colour temperatures 2700K, 3000K, 3500K or 4000K. Binning initial ≤ MacAdam 3. Colour rendering CRI>80 or CRI>90. Sophisticated mounting system for easy installation and stable hold. On request: Integration of emergency lighting components, sensor technology.

**FR** Luminaire LED en saillie pour murs et plafonds. Éclairage seulement direct. Corps du luminaire en profilé aluminium. Surface anodisée ou laquée blanc, graphite, noir, champagne ou polie. Autres options de finition voir Lightnet-Surface-Collection ou RAL au choix. Diffuseur microprismatique optimisé pour un éblouissement limité et adapté aux bureaux. Diffuseur opale satiné pour un éclairage général et une transmission maximale et homogène. Driver intégré dans le luminaire, au choix ON/OFF ou graduable (1-10V, DALI, Touch-Dim, Casambi). Température de couleur 2700K, 3000K, 3500K ou 4000K. Binning initial ≤ MacAdam 3. Rendu de couleur CRI>80 ou CRI>90. Système de montage sophistiqué pour une installation facile et stable. Sur demande: Intégration de composants d'éclairage de secours ou de capteurs.

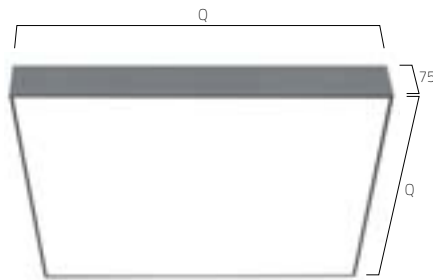

**PRODUCT-CODE:** C A2 A E E - 8 30 M - Q330

PRODUCT FAMILY	- C: Cubic
TYPE	- A2: Direct Only
OPTICAL SYSTEM	- A: Microprismatic, O: Opal
SURFACE FINISH	- W: Snow White, E: Silver Anodised, U: Urban Graphite, B: Jet Black, H: Champagne Silver, P: Polished Aluminium
CONTROL GEAR	- E: On/Off, L: DALI, D: 1-10V, H: Touch-Dim, C: Casambi
COLOUR REND.	- 8: CRI>80, 9: CRI>90, F: Full Spectrum
COLOUR TEMP.	- 27: 2700K, 30: 3000K, 35: 3500K, 40: 4000K, TW: Tunable White 2700-6500K
POWER	- M: Medium Power, H: High Power
SIZE	- Square Size in mm: Q330, Q430, Q530, Q630, Q900, Q1200
ON REQUEST	- Emergency Module, Radar Sensor



MICROPRISMATIC / DIRECT

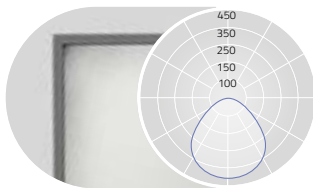

UGR≤19 for Medium Power (X=4H, Y=8H, S=0.25H)  
DIRECT: 100%

OPAL DIFFUSER / DIRECT

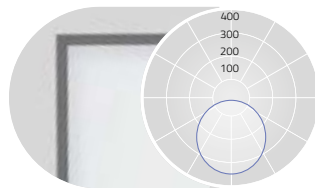

DIRECT: 100%

Q mm	Lumen/Watt Medium Power	Lumen/Watt High Power
330	1360lm/12W	2010lm/18W
430	2370lm/20W	3450lm/29W
530	3630lm/27W	6790lm/51W
630	5200lm/40W	8500lm/65W
900	7910lm/67W	13240lm/129W
1200	14100lm/122W	23550lm/228W

Q mm	Lumen/Watt Medium Power	Lumen/Watt High Power
330	1400lm/12W	2070lm/18W
430	2440lm/20W	3550lm/29W
530	3740lm/27W	6990lm/51W
630	5360lm/40W	8760lm/65W
900	8150lm/67W	13640lm/129W
1200	14520lm/122W	24260lm/228W

Lumen Values: Luminaire luminous flux at 4000K/CRI>80. Other configurations on request.



CUBIC  
SURFACE | Y2/X2



**DE** LED-Anbauleuchte für Wand- oder Deckenmontage. Direktstrahlend und indirekte Lichtkorona oder rein direktstrahlend. Leuchtenkörper aus Aluminiumprofil. Oberfläche natureloxiert oder weiß, graphit, schwarz bzw. champagnerfarben lackiert sowie Alu poliert. Weitere Oberflächenoptionen siehe Lightnet-Surface-Collection oder RAL nach Wahl. Microprismenoptik mit optimierter Blendungsbegrenzung speziell für Office-Anwendungen. Satinierter Opaldiffusor für Allgemeinbeleuchtung mit max. Transmissionsgrad und homogener Lichtpunktauflösung. Konverter in Leuchtgehäuse integriert, wahlweise einfach schaltbar oder stufenlos dimmbar (1-10V, DALI, Touch-Dim, Casambi). Farbtemperaturen 2700K, 3000K, 3500K, 4000K. Binning initial  $\leq$  MacAdam 3. Farbwiedergabe CRI>80 oder CRI>90. Durchdachtes Montagesystem für einfache Installation und stabilen Halt. Auf Anfrage: Integration von Notlichtkomponenten, Sensortechnologie.

**EN** LED surface-mounted luminaire for walls or ceilings. Direct light distribution and Indirect lighting corona or Direct only light distribution. Luminaire body made of aluminum profile. Surface natural anodised or white, graphite, black or champagne coated as well as polished aluminium. Further surface options see Lightnet-Surface-Collection or RAL of your choice. Microprismatic with optimized glare reduction especially for workplaces. Satin opal diffuser for general lighting with maximum transmittance and homogeneous lighting. Driver integrated into luminaire housing, optionally switchable or dimmable (1-10V, DALI, Touch-Dim, Casambi). Colour temperatures 2700K, 3000K, 3500K, 4000K. Binning initial  $\leq$  MacAdam 3. Colour rendering CRI>80 or CRI>90. Sophisticated mounting system for easy installation and stable hold. On request: Integration of emergency lighting components, sensor technology.

**FR** Luminaire LED en saillie pour murs et plafonds. Éclairage directe et corona d'éclairage indirect ou éclairage seulement direct. Corps du luminaire en profilé aluminium. Surface anodisée ou laquée blanc, graphite, noir, champagne ou polie. Autres options de finition voir Lightnet-Surface-Collection ou RAL au choix. Diffuseur microprismatique optimisé pour un éblouissement limité et adapté aux bureaux. Diffuseur opale satiné pour un éclairage général et une transmission maximale et homogène. Driver intégré dans le luminaire, au choix ON/OFF ou graduable (1-10V, DALI, Touch-Dim, Casambi). Température de couleur 2700K, 3000K, 3500K, 4000K. Binning initial  $\leq$  MacAdam 3. Rendu de couleur CRI>80 ou CRI>90. Système de montage sophistiqué pour une installation facile et stable. Sur demande: Intégration de composants d'éclairage de secours ou de capteurs.

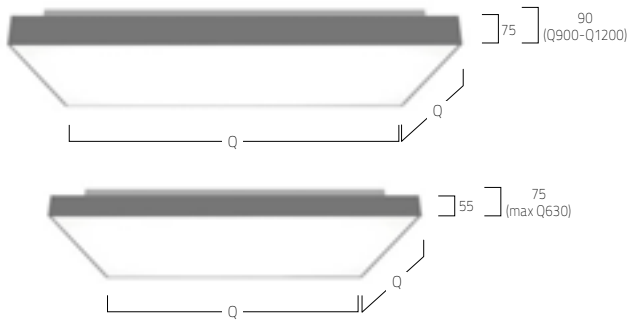

**PRODUCT-CODE:** C X2 O E E - 8 30 M - Q430

PRODUCT FAMILY	- C: Cubic
TYPE	- X2: Direct-Indirect, Y2: Direct Only
OPTICAL SYSTEM	- O: Opal, A: Microprismatic
SURFACE FINISH	- W: Snow White, E: Silver Anodised, U: Urban Graphite, B: Jet Black, H: Champagne Silver, K: Satin Copper
CONTROL GEAR	- E: On/Off, L: DALI, D: 1-10V, H: Touch-Dim, C: Casambi
COLOUR REND.	- 8: CRI>80, 9: CRI>90, F: Full Spectrum
COLOUR TEMP.	- 27: 2700K, 30: 3000K, 35: 3500K, 40: 4000K, TW: Tunable White 2700-6500K [Q430-Q1200]
POWER	- M: Medium Power, H: High Power
SIZE	- Square Size in mm: Q330, Q430, Q530, Q630, Q900, Q1200
ON REQUEST	- Emergency Module, Radar Sensor



MICROPRISMATIC / DIRECT-INDIRECT

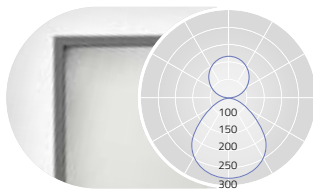

UGR $\leq$ 19 (X=4H, Y=8H, S=0.25H)  
DIRECT: ca.60% INDIRECT ca.40%

Q mm	Lumen/Watt Medium Power	Lumen/Watt High Power
330	2470lm/19W	3640lm/28W
430	4360lm/31W	6300lm/45W
530	6000lm/40W	11170lm/80W
630	9610lm/68W	14270lm/103W
900	11790lm/96W	19040lm/173W
1200	19520lm/161W	31640lm/288W

MICROPRISMATIC / DIRECT

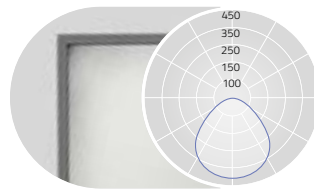

UGR $\leq$ 19 for Medium Power (X=4H, Y=8H, S=0.25H)  
DIRECT: 100%

Q mm	Lumen/Watt Medium Power	Lumen/Watt High Power
330	1360lm/12W	2010lm/18W
430	2370lm/20W	3450lm/29W
530	3630lm/27W	6790lm/51W
630	5200lm/40W	8500lm/65W
900	7910lm/67W	13240lm/129W
1200	14100lm/122W	23550lm/228W

OPAL DIFFUSER / DIRECT-INDIRECT

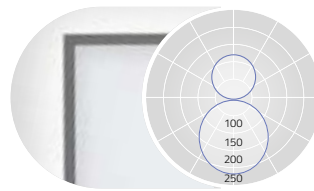

DIRECT: ca.60% INDIRECT ca.40%

Q mm	Lumen/Watt Medium Power	Lumen/Watt High Power
330	2510lm/19W	3700lm/28W
430	4430lm/31W	6400lm/45W
530	6110lm/40W	11370lm/80W
630	9770lm/68W	14530lm/103W
900	12030lm/96W	19440lm/173W
1200	19940lm/161W	32350lm/288W

OPAL DIFFUSER / DIRECT

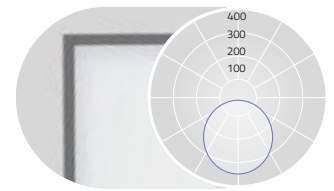

DIRECT: 100%

Q mm	Lumen/Watt Medium Power	Lumen/Watt High Power
330	1400lm/12W	2070lm/18W
430	2440lm/20W	3550lm/29W
530	3740lm/27W	6990lm/51W
630	5360lm/40W	8760lm/65W
900	8150lm/67W	13640lm/129W
1200	14520lm/122W	24260lm/228W

Lumen Values: Luminaire luminous flux at 4000K/CRI>80. Other configurations on request.





CUBIC AMBIENT  
SURFACE | A7



**DE** LED- Anbauleuchte. Direkt-rundumstrahlend für dezente Deckenaufhellung. Leuchtenkörper aus Aluminium. Oberfläche natureloxiert oder weiß, graphit, schwarz bzw. champagnerfarben lackiert. Weitere Oberflächeoptionen siehe Lightnet-Surface-Collection oder RAL nach Wahl. Ambientdiffusor aus satiniertem Acrylglas für Allgemeinbeleuchtung. Konverter in Leuchtengehäuse integriert, wahlweise einfach schaltbar oder stufenlos dimmbar (1-10V, DALI, Touch-Dim, Casambi). Farbtemperaturen 2700K, 3000K, 3500K oder 4000K. Binning initial ≤ MacAdam 3. Farbwiedergabe CRI>80 oder CRI>90. Auf Anfrage: Integration von Notlichtkomponenten, Sensortechnologie.

**EN** LED surface-mounted luminaire. Omnidirectional light distribution for discreet illumination of the ceiling. Luminaire body made of aluminium. Surface natural anodised or white, graphite, black or champagne coated. Further surface options see Lightnet-Surface-Collection or RAL of your choice. Ambient diffuser made of frosted acrylic glass for general lighting. Driver integrated into luminaire housing, optionally switchable or dimmable (1-10V, DALI, Touch-Dim, Casambi). Colour temperature 2700K, 3000K, 3500K or 4000K. Binning initial ≤ MacAdam 3. Colour rendering CRI>80 or CRI>90. On request: Integration of emergency lighting components, sensor technology.

**FR** Luminaire LED en saillie. Cadre de montage périphérique avec une hauteur totale visible de seulement 18 mm. Corps du luminaire en aluminium. Surface anodisée ou laquée blanc, graphite, noir ou champagne. Autres options de finition voir Lightnet-Surface-Collection ou RAL au choix. Diffuseur AMBIENT en verre satiné acrylique pour diverses applications d'éclairage. Driver intégré dans le luminaire, au choix ON/OFF ou graduable (1-10V, DALI, Touch-Dim, Casambi). Température de couleur 2700K, 3000K, 3500K ou 4000K. Binning initial ≤ MacAdam 3. Rendu de couleur CRI>80 ou CRI>90. Sur demande: Intégration de composants d'éclairage de secours ou de capteurs.



**PRODUCT-CODE:** C A7 F B E - 8 30 M - Q300

- PRODUCT FAMILY – C: Cubic
- TYPE – A7: Surface Direct Only
- OPTICAL SYSTEM – F: Ambient
- SURFACE FINISH – W: Snow White, S: Radiant Silver, U: Urban Graphite, B: Jet Black, H: Champagne Silver
- CONTROL GEAR – E: On/Off, L: DALI, D: 1-10V, H: Touch-Dim, C: Casambi
- COLOUR REND. – 8: CRI>80, 9: CRI>90, F: Full Spectrum
- COLOUR TEMP. – 27: 2700K, 30: 3000K, 35: 3500K, 40: 4000K
- POWER – M: Medium Power, H: High Power
- SIZE – Square Size in mm: Q300, Q400, Q500, Q600
- ON REQUEST – Emergency Module, Radar Sensor



AMBIENT DIFFUSER / DIRECT



DIRECT: ca.98% INDIRECT: ca.2%

Q mm	Lumen/Watt Medium Power	Lumen/Watt High Power
300	1460lm/12W	2150lm/18W
400	2510lm/20W	3660lm/29W
500	3810lm/27W	7130lm/51W
600	5410lm/40W	8850lm/65W

Lumen Values: Luminaire luminous flux at 4000K/CRI>80. Other configurations on request.

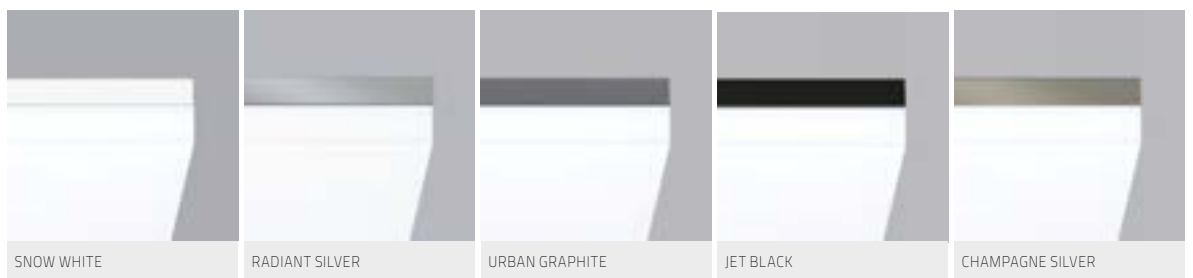

MATRIC 38<sub>MM</sub> SQUARE  
SURFACE | A1



**DE** LED-Anbauleuchte. Rein direktstrahlend. Lichtkanal aus Aluminiumprofil mit 38mm Lichtspur-Breite. Oberfläche silber, weiß, graphit, schwarz, champagner oder kupferfarben lackiert. Weitere Oberflächenoptionen siehe Lightnet-Surface-Collection oder RAL nach Wahl. Microprismenoptik mit optimierter Blendungsbegrenzung speziell für Office-Anwendungen. Satiniertes Opaldiffusor für Allgemeinbeleuchtung. Konverter in Leuchtengehäuse integriert, wahlweise einfach schaltbar oder stufenlos dimmbar (1-10V, DALI, Touch-Dim, Casambi). Farbtemperaturen 2200K, 2700K, 3000K, 3500K, 4000K oder 6500K. Binning initial  $\leq$  MacAdam 3. Farbwiedergabe CRI>80 oder CRI>90. Lieferung erfolgt als fertig montierbare Einheit mit laser-verschweißten Ecken und durchgehend homogener Auflösung der Lichtpunkte. Auf Anfrage: Integration von Notlichtkomponenten, Sensortechnologie sowie Vielzahl weiterer Optionen.

**EN** LED surface-mounted luminaire. Direct only light distribution. Light channel made of aluminium profile with 38mm profile width. Surface silver, white, graphite, black, champagne or copper coated. Further surface options see Lightnet-Surface-Collection or RAL of your choice. Microprismatic with optimized glare reduction especially for workplaces. Satin opal diffuser for general lighting. Driver integrated into luminaire housing, optionally switchable or dimmable (1-10V, DALI, Touch-Dim, Casambi). Colour temperatures 2200K, 2700K, 3000K, 3500K, 4000K or 6500K. Binning initial  $\leq$  Mac Adam 3. Colour rendering CRI>80 or CRI>90. Supplied as a ready-to-mount unit with laser-welded corners and uniform and enhanced light transmission. On request: Integration of emergency lighting components, sensor technology as well as many other options.

**FR** Applique murale LED. Éclairage seulement direct. Rail lumineux en profilé d'aluminium avec une largeur d'éclairage de 38 mm. Surface laquée argent, blanc, graphite, noir, champagne ou cuivre. Autres options de finition voir Lightnet-Surface-Collection ou RAL au choix. Diffuseur microprismatique optimisé pour un éblouissement limité et adapté aux bureaux. Diffuseur opale satinée pour un éclairage général. Driver intégré dans le luminaire, au choix ON/OFF ou graduable (1-10V, DALI, Touch-Dim, Casambi). Température de couleur 2200K, 2700K, 3000K, 3500K, 4000K ou 6500K. Binning initial  $\leq$  MacAdam 3. Rendu de couleur CRI>80 ou CRI>90. Livraison sous forme d'unité prête au montage avec angles soudés au laser et distribution homogène et continue des points lumineux. Sur demande: Intégration de composants d'éclairage de secours ou de capteurs ainsi qu'une multitude d'autres options.

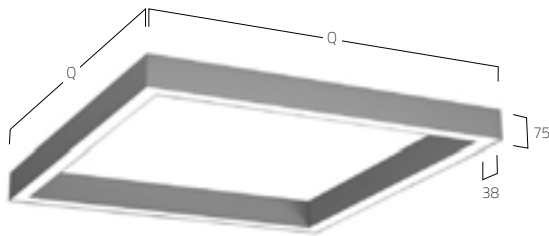

**PRODUCT-CODE: L A I A S E - 8 30 M - Q920**

- PRODUCT FAMILY – L: Matrix
- TYPE – A1: Surface Direct Only
- OPTICAL SYSTEM – O: Opal, A: Microprismatic
- SURFACE FINISH – W: Snow White, S: Radiant Silver, U: Urban Graphite, B: Jet Black, H: Champagne Silver, K: Satin Copper
- CONTROL GEAR – E: On/Off, L: DALI, D: 1-10V, H: Touch-Dim, A: Casambi Micro
- COLOUR REND. – 8: CRI>80, 9: CRI>90, F: Full Spectrum
- COLOUR TEMP. – 22: 2200K, 27: 2700K, 30: 3000K, 35: 3500K, 40: 4000K, 65: 6500K, TW: Tunable White 2700-6500K
- POWER – M: Medium Power, H: High Power
- SIZE – Luminaire length in mm: Q630, Q920, Q1210, Q1500
- ON REQUEST – Magnetic Track, 3-Phase Track, Midpin Spotlights, Lens Louver-Inset, Emergency Module, Multisensor

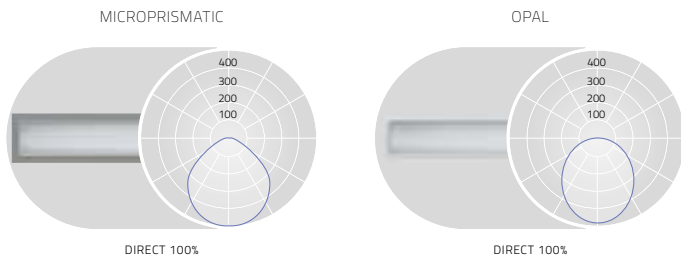

L mm	Lumen/Watt	
	Medium Power	High Power
630	3350lm/29W	4540lm/40W
920	5030lm/43W	6800lm/59W
1210	6710lm/56W	9070lm/78W
1500	8390lm/69W	11340lm/99W

L mm	Lumen/Watt	
	Medium Power	High Power
630	3610lm/29W	4880lm/40W
920	5420lm/43W	7320lm/59W
1210	7220lm/56W	9760lm/78W
1500	9020lm/69W	12200lm/99W

Lumen Values: Luminaire luminous flux at 4000K/CRI>80. Other configurations on request.



# MATRIC SURFACE





HUMBOLDT UNIVERSITÄT, SCHLACHTERHALLE, BERLIN, GERMANY  
MTRIC A1

# MATRIC SURFACE



GRUNDSCHULE RAHEWINKEL, HAMBURG, GERMANY  
MATRIC-A5  
PHOTOS: ULRICH HOPPE



GALERIE LAING, MÜNSTER, GERMANY  
MATRIC-A3



THE HUB, DUBLIN CITY UNIVERSITY, IRELAND  
MATRIC-A5



# MATRIC SURFACE



VISIRON, MUNICH, GERMANY  
MATRIC-A3  
PHOTOS: MARTIN KREUZER



# MATRIC 38 MM LENS LOUVER SURFACE | A1



**DE** LED-Anbauleuchte. Rein direktstrahlend. Lichtkanal aus Aluminiumprofil mit 38mm Lichtspur-Breite. Millimetergenaue Längenfertigung nach Vorgabe möglich. Oberfläche natureloxiert oder weiß, graphit, schwarz, champagner oder kupferfarben lackiert. Weitere Oberflächenoptionen siehe Lightnet-Surface-Collection oder RAL nach Wahl. Präzisionslinsen mit Abblendraster für breite rotationssymmetrische Lichtstärkeverteilung bei gleichzeitig hoher Blendungsbegrenzung (UGR<16). Raster in verschiedenen Farbausführung erhältlich. Konverter in Leuchtgehäuse integriert, wahlweise einfach schaltbar oder stufenlos dimmbar (1-10V, DALI, Touch-Dim, Casambi). Farbtemperaturen 2700K, 3000K oder 4000K. Binning initial ≤ MacAdam 3. Farbwiedergabe CRI>80.

**EN** LED surface-mounted luminaire. Direct only light distribution. Light channel made of aluminium profile with 38mm profile width. Precise length production according to specifications possible. Surface natural anodised or white, graphite, black, champagne or copper coated. Further surface options see Lightnet-Surface-Collection or RAL of your choice. Precision lenses with louvre for wide rotationally symmetrical light distribution with high glare limitation (UGR<16). Louvre available in various colour combinations. Driver integrated into luminaire housing, optionally switchable or dimmable (1-10V, DALI, Touch-Dim, Casambi). Colour temperature 2700K, 3000K or 4000K. Binning initial ≤ MacAdam 3. Colour rendering CRI>80.

**FR** Luminaire LED en saillie. Éclairage seulement direct. Rail lumineux en profilé d'aluminium avec une largeur d'éclairage de 38 mm. Fabrication au millimètre près des longueurs selon les spécifications. Surface anodisée ou laquée blanc, graphite, noir, champagne ou cuivre. Autres options de finition voir Lightnet-Surface-Collection ou RAL au choix. Lentilles de précision avec grille antiéblouissement pour une large répartition symétrique de l'intensité lumineuse et facteur d'antiéblouissement très bas (UGR<16). Grille antiéblouissement disponible en plusieurs combinaisons de couleurs. Driver intégré dans le luminaire, au choix ON /OFF ou graduable (1-10V, DALI, Touch-Dim, Casambi). Température de couleur 2700K, 3000K ou 4000K. Binning initial ≤ MacAdam 3. Rendu de couleur CRI>80.

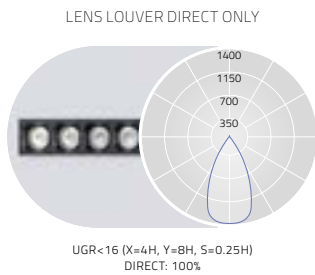
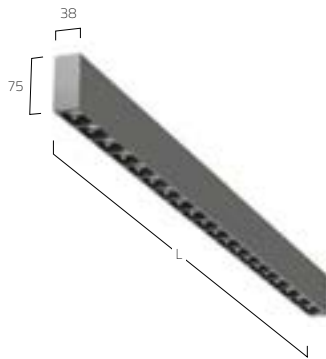

L mm	Lumen/Watt Low Power	Lumen/Watt Medium Power
669	1260lm/15W	2030lm/24W
953	1800lm/20W	2900lm/33W
1237	2340lm/25W	3770lm/42W
1521	2880lm/31W	4640lm/52W
1805	3420lm/36W	5510lm/61W

**PRODUCT-CODE:** L A1 L E L - 8 30 M - L1805 - B

PRODUCT FAMILY	L: Matric
TYPE	A1: Direct Only
OPTICAL SYSTEM	L: Lens Louver
SURFACE FINISH	W: Snow White, V: Ivory White, E: Silver Anodised, U: Urban Graphite, B: Jet Black, H: Champagne Silver, K: Satin Copper, A: Satin Silver
CONTROL GEAR	E: On/Off, L: DALI, D: 1-10V, H: Touch-Dim, A: Casambi Micro
COLOUR REND.	8: CRI>80
COLOUR TEMP.	27: 2700K, 30: 3000K, 40: 4000K
POWER	E: Low Power, M: Medium Power
SIZE	Luminaire Length in mm: L669, L953, L1237, L1521, L1805
REFLECTOR	W: Snow White, C: Specular Chrome, B: Jet Black, A: Satin Silver, H: Champagne Silver, K: Satin Copper, N: Satin Platinum, G: Satin Gold



MATRIC 38 MM  
SURFACE | A1

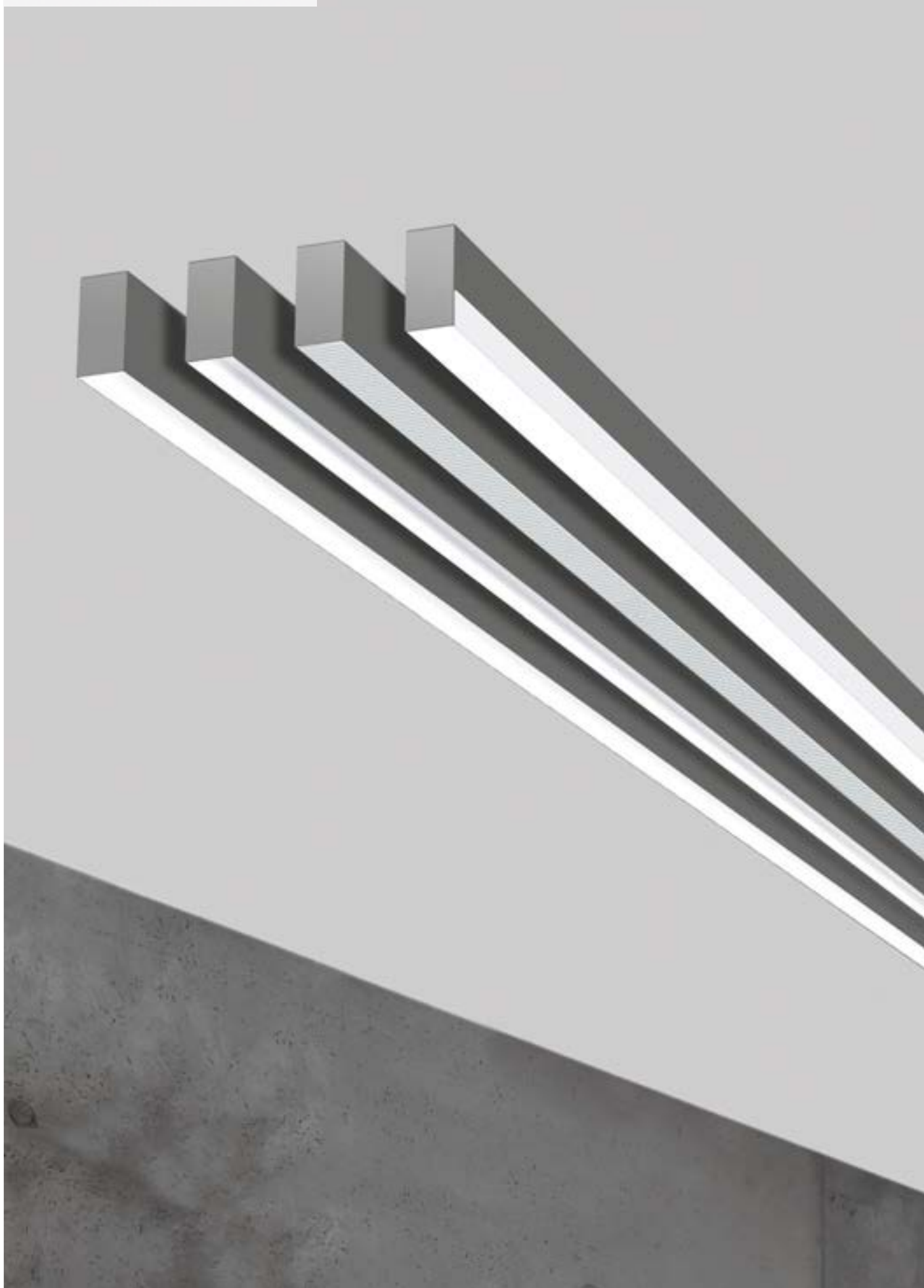

**DE** LED-Anbauleuchte. Rein direktstrahlend. Lichtkanal aus Aluminiumprofil mit 38mm Lichtspur-Breite. Millimetergenaue Längenfertigung nach Vorgabe möglich. Oberfläche natureloxiert oder weiß, graphit, schwarz, champagner oder kupferfarben lackiert. Weitere Oberflächenoptionen siehe Lightnet-Surface-Collection oder RAL nach Wahl. Microprismenoptik mit optimierter Blendungsbegrenzung speziell für Office-Anwendungen. Opaldiffusor aus satiniertem Acrylglas sowie Ambientdiffusor rundumstrahlend für Allgemeinbeleuchtung. Wallwasher für homogene vertikale Beleuchtung. Konverter in Leuchtgehäuse integriert, wahlweise einfach schaltbar oder stufenlos dimmbar (1-10V, DALI, Touch-Dim, Casambi). Farbtemperaturen 2200K, 2700K, 3000K, 3500K, 4000K oder 6500K. Binning initial ≤ MacAdam 3. Farbwiedergabe CRI>80 oder CRI>90. Auf Anfrage: Integration von Notlichtkomponenten, Sensortechnologie sowie Vielzahl weiterer Optionen.

**EN** LED surface-mounted luminaire. Direct only light distribution. Light channel made of aluminium profile with 38mm track width. Precise length production according to specifications possible. Surface natural anodised or white, graphite, black, champagne or copper coated. Further surface options see Lightnet-Surface-Collection or RAL of your choice. Microprismatic screen with optimized glare reduction especially for workplaces, optionally switchable or dimmable (1-10V, DALI, Touch-Dim, Casambi). Colour temperatures 2200K, 2700K, 3000K, 3500K, 4000K or 6500K. Binning initial ≤ MacAdam 3. Colour rendering CRI>80 or CRI>90. On request: Integration of emergency lighting components, sensor technology as well as many other options.

**FR** Luminaire LED en saillie. Éclairage seulement direct. Rail lumineux en profilé d'aluminium avec une largeur d'éclairage de 38 mm. Fabrication au millimètre près des longueurs selon les spécifications. Surface anodisée ou laquée blanc, graphite, noir, champagne ou cuivre. Autres options de finition voir Lightnet-Surface-Collection ou RAL au choix. Diffuseur microprismatique optimisé pour un éblouissement limité et adapté aux bureaux. Diffuseur opale en verre acrylique satiné et diffuseur ambiant avec répartition lumineuse latérale pour diverses applications d'éclairage. Wallwasher pour un éclairage vertical homogène. Driver intégré dans le luminaire, au choix ON/OFF ou graduable (1-10V, DALI, Touch-Dim, Casambi). Température de couleur 2200K, 2700K, 3000K, 3500K, 4000K ou 6500K. Binning initial ≤ MacAdam 3. Rendu de couleur CRI>80 ou CRI>90. Sur demande: Intégration de composants d'éclairage de secours ou de capteurs ainsi qu'une multitude d'autres options.

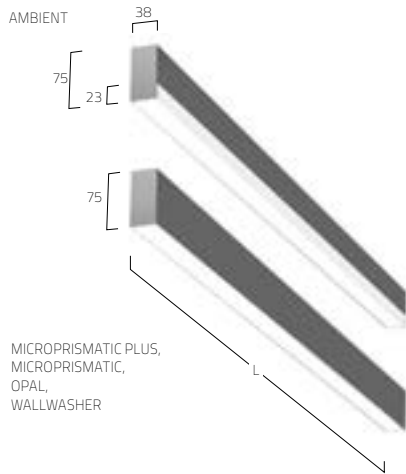

**PRODUCT-CODE:** L A 1 A E E - 8 30 M - L1182

PRODUCT FAMILY	- L: Matric
TYPE	- A1: Surface Direct Only
OPTICAL SYSTEM	- H: Microprismatic Plus, A: Microprismatic, O: Opal, F: Ambient, G: Wallwasher
SURFACE FINISH	- W: Snow White, E: Silver Anodised, U: Urban Graphite, B: Jet Black, H: Champagne Silver, K: Satin Copper
CONTROL GEAR	- E: On/Off, L: DALI, D: 1-10V, H: Touch-Dim, A: Casambi Micro
COLOUR REND.	- 8: CRI>80, 9: CRI>90, F: Full Spectrum
COLOUR TEMP.	- 22: 2200K, 27: 2700K, 30: 3000K, 35: 3500K, 40: 4000K, 65: 6500K, TW: Tunable White 2700-6500K (L890-L2055)
POWER	- M: Medium Power, H: High Power
SIZE	- Luminaire length in mm: L600, L890, L1182, L1475, L1765, L2055
ON REQUEST	- Special Length Versions, 90°-Corner, Curve-Elements, Magnetic Track, 3-Phase Track, Midpin Spotlights, Lens Louver-Inset, Emergency Module, Multisensor

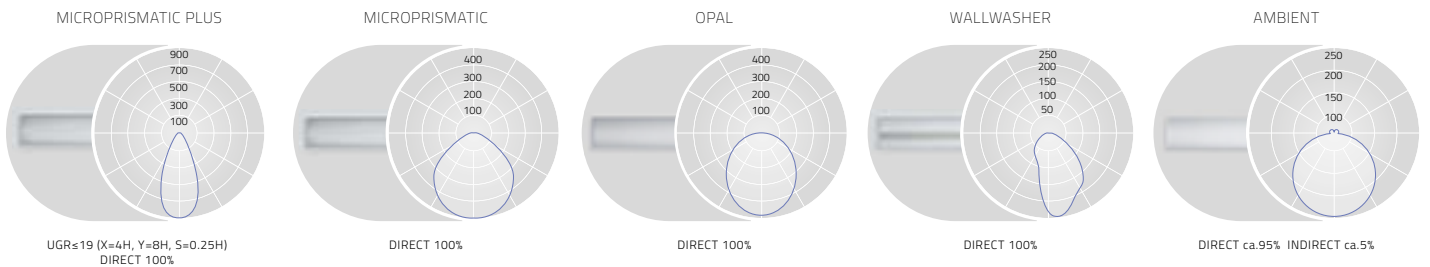

L mm	Lumen/Watt Medium Power	Lumen/Watt Medium Power	Lumen/Watt High Power	L mm	Lumen/Watt Medium Power	Lumen/Watt Medium Power	Lumen/Watt High Power	L mm	Lumen/Watt Medium Power	Lumen/Watt Medium Power	Lumen/Watt High Power	L mm	Lumen/Watt Medium Power	Lumen/Watt Medium Power	Lumen/Watt High Power	L mm	Lumen/Watt Medium Power	Lumen/Watt Medium Power	Lumen/Watt High Power
600	820lm/8W	840lm/9W	1130lm/12W	600	900lm/9W	1220lm/12W	1220lm/12W	600	880lm/9W	1180lm/12W	1180lm/12W	600	1140lm/9W	1540lm/12W	1540lm/12W	600	1140lm/9W	1540lm/12W	1540lm/12W
890	1240lm/12W	1260lm/13W	1700lm/17W	890	1350lm/13W	1830lm/17W	1830lm/17W	890	1310lm/13W	1780lm/17W	1780lm/17W	890	1710lm/13W	2310lm/17W	2310lm/17W	890	1710lm/13W	2310lm/17W	2310lm/17W
1182	1650lm/15W	1680lm/16W	2270lm/22W	1182	1810lm/16W	2440lm/22W	2440lm/22W	1182	1750lm/16W	2370lm/22W	2370lm/22W	1182	2280lm/16W	3080lm/22W	3080lm/22W	1182	2280lm/16W	3080lm/22W	3080lm/22W
1475	2060lm/17W	2100lm/20W	2840lm/26W	1475	2260lm/20W	3050lm/26W	3050lm/26W	1475	2190lm/20W	2960lm/26W	2960lm/26W	1475	2850lm/20W	3850lm/26W	3850lm/26W	1475	2850lm/20W	3850lm/26W	3850lm/26W
1765	2480lm/20W	2520lm/23W	3400lm/31W	1765	2710lm/23W	3660lm/31W	3660lm/31W	1765	2630lm/23W	3550lm/31W	3550lm/31W	1765	3420lm/23W	4620lm/31W	4620lm/31W	1765	3420lm/23W	4620lm/31W	4620lm/31W
2055	2880lm/23W	2940lm/26W	3970lm/35W	2055	3160lm/26W	4270lm/35W	4270lm/35W	2055	3070lm/26W	4140lm/35W	4140lm/35W	2055	3990lm/26W	5390lm/35W	5390lm/35W	2055	3990lm/26W	5390lm/35W	5390lm/35W

Lumen Values: Luminaire luminous flux at 4000K/CRI>80. Other configurations on request.



MATRIC 55 MM  
SURFACE | A3

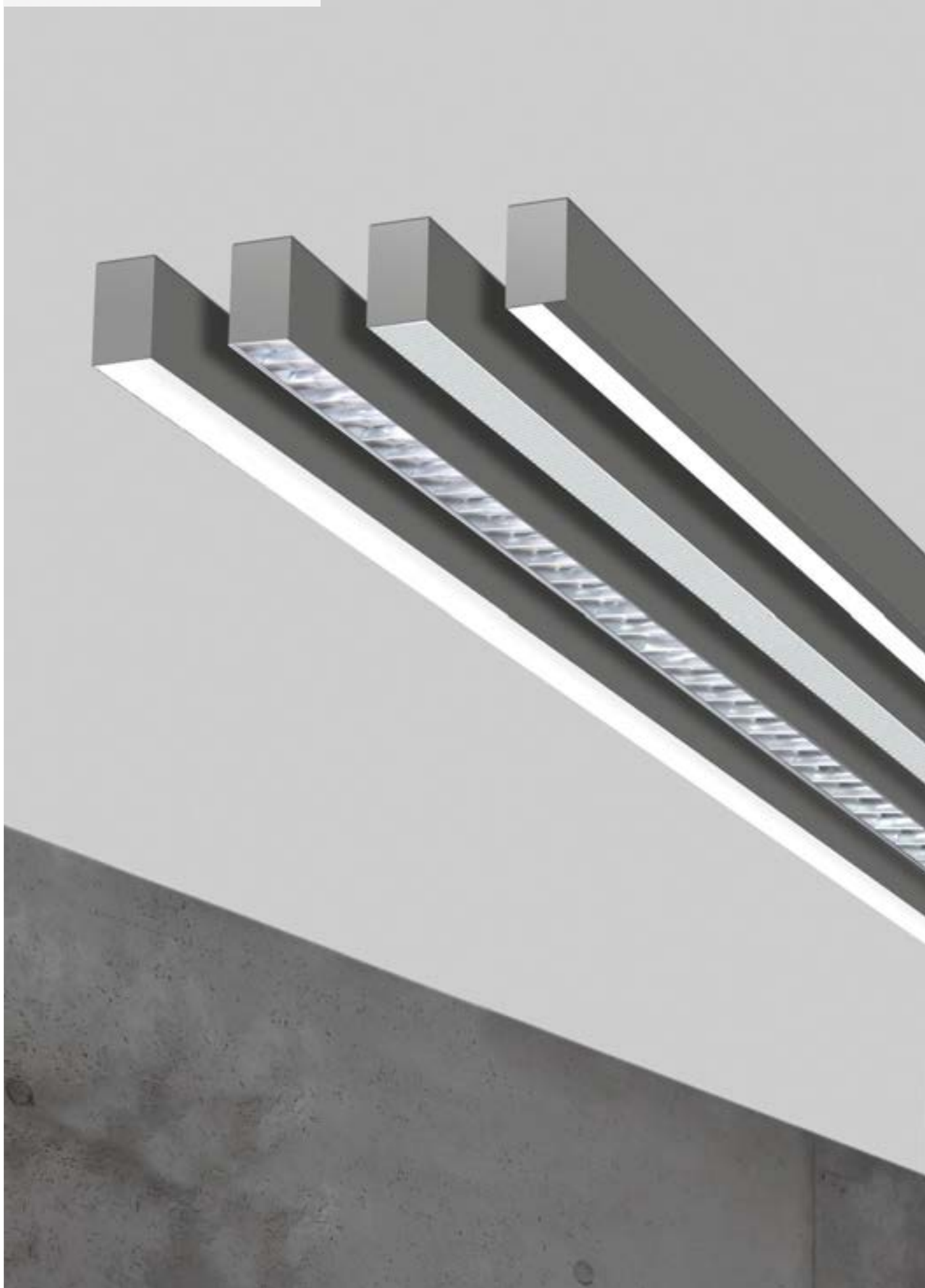

**DE** LED-Anbauleuchte. Rein direktstrahlend. Lichtkanal aus Aluminiumprofil mit 55mm Lichtspur-Breite. Millimetergenaue Längenfertigung nach Vorgabe möglich. Oberfläche natureloxiert oder weiß, graphit, schwarz, champagner oder kupferfarben lackiert. Weitere Oberflächenoptionen siehe Lightnet-Surface-Collection oder RAL nach Wahl. Microprismenoptik und Satin-Louver mit optimierter Blendungsbegrenzung speziell für Office-Anwendungen. Opaldiffusor aus satiniertem Acrylglas für Allgemeinbeleuchtung. Wallwasher für homogene vertikale Beleuchtung. Konverter in Leuchtgehäuse integriert, wahlweise einfach schaltbar oder stufenlos dimmbar (1-10V, DALI, Touch-Dim, Casambi). Farbtemperaturen 2200K, 2700K, 3000K, 3500K, 4000K oder 6500K. Binning initial ≤ MacAdam 3. Farbwiedergabe CRI>80 oder CRI>90. Auf Anfrage: Integration von Notlichtkomponenten, Sensortechnologie sowie Vielzahl weiterer Optionen.

**EN** LED surface-mounted luminaire. Direct only light distribution. Light channel made of aluminium profile with 55mm track width. Precise length production according to specifications possible. Surface natural anodised or white, graphite, black, champagne or copper coated. Further surface options see Lightnet-Surface-Collection or RAL of your choice. Microprismatic and satin louver with optimized glare limitation especially for office purposes. Opal diffuser made of acrylic glass for general lighting. Wallwasher for homogeneous vertical illuminance. Converter integrated into luminaire housing, optionally switchable or dimmable (1-10V, DALI, Touch-Dim, Casambi). Colour temperatures 2200K, 2700K, 3000K, 3500K, 4000K or 6500K. Binning initial ≤ MacAdam 3. Colour rendering CRI>80 or CRI>90. On request: Integration of emergency lighting components, sensor technology as well as many other options.

**FR** Luminaire LED en saillie. Éclairage seulement direct. Rail lumineux en profilé d'aluminium avec une largeur d'éclairage de 55mm. Fabrication au millimètre près des longueurs selon les spécifications. Surface anodisée ou laquée blanc, graphite, noir, champagne ou cuivre. Autres options de finition voir Lightnet-Surface-Collection ou RAL au choix. Diffuseur microprismatique ou Satin-Louver avec une limitation optimisée de l'éblouissement pour les postes de travail. Diffuseur opale en verre acrylique pour éclairage général. Wallwasher pour un éclairage vertical homogène. Driver intégré dans le luminaire, au choix ON/OFF ou graduable (1-10V, DALI, Touch-Dim, Casambi). Température de couleur 2200K, 2700K, 3000K, 3500K, 4000K ou 6500K. Binning initial ≤ MacAdam 3. Rendu de couleur CRI>80 ou CRI>90. Sur demande: Intégration de composants d'éclairage de secours ou de capteurs ainsi qu'une multitude d'autres options.

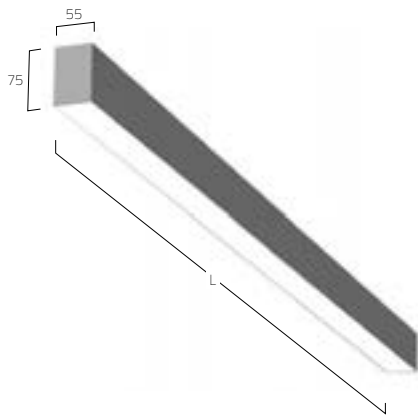

**PRODUCT-CODE:** L A3 A E E - 8 30 M - L890

- PRODUCT FAMILY – L: Matrix
- TYPE – A3: Surface Direct Only
- OPTICAL SYSTEM – O: Opal, A: Microprismatic, M: Satin Louver, G: Wallwasher
- SURFACE FINISH – W: Snow White, E: Silver Anodised, U: Urban Graphite, B: Jet Black, H: Champagne Silver, K: Satin Copper
- CONTROL GEAR – E: On/Off, L: DALI, D: 1-10V, H: Touch-Dim, C: Casambi
- COLOUR REND. – 8: CRI>80, 9: CRI>90, F: Full Spectrum
- COLOUR TEMP. – 22: 2200K, 27: 2700K, 30: 3000K, 35: 3500K, 40: 4000K, 65: 6500K, TW: Tunable White 2700-6500K [L890-L2055]
- POWER – E: Low Power, M: Medium Power, H: High Power
- SIZE – Luminaire length in mm: L600, L890, L1182, L1475, L1765, L2055
- ON REQUEST – Special Length Versions, 90° Corner, 3-Phase Track, Midpin/Midpoint Spotlights/Downlights, Emergency Module, Multisensor

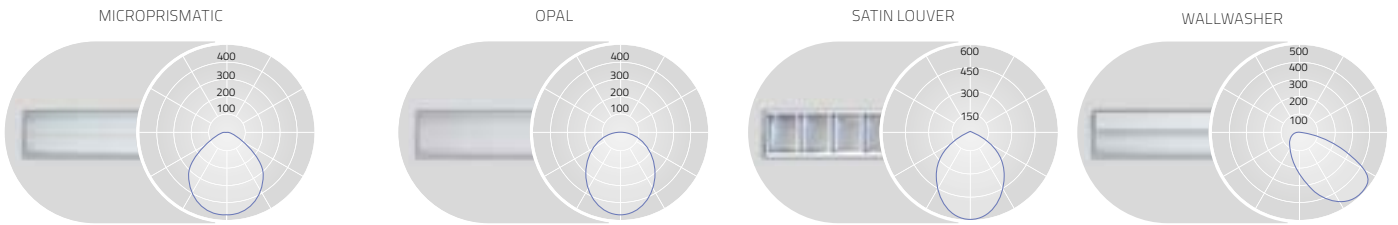

UGR<19 for Low Power (X=4H, Y=8H, S=0.25H) DIRECT 100%

DIRECT 100%

UGR<19 for Medium Power (X=4H, Y=8H, S=0.25H) DIRECT 100%

DIRECT 100%

L mm	Lumen/Watt Low Power	Lumen/Watt Medium Power	Lumen/Watt High Power
600	780lm/8W	1300lm/13W	1890lm/19W
890	1170lm/12W	1950lm/19W	2830lm/28W
1182	1560lm/15W	2600lm/24W	3780lm/36W
1475	1950lm/17W	3250lm/29W	4720lm/44W
1765	2340lm/20W	3900lm/34W	5670lm/52W
2055	2730lm/23W	4550lm/39W	6610lm/58W

L mm	Lumen/Watt Low Power	Lumen/Watt Medium Power	Lumen/Watt High Power
600	830lm/8W	1390lm/13W	2010lm/19W
890	1250lm/12W	2080lm/19W	3020lm/28W
1182	1660lm/15W	2770lm/24W	4030lm/36W
1475	2080lm/17W	3470lm/29W	5040lm/44W
1765	2490lm/20W	4160lm/34W	6040lm/52W
2055	2910lm/23W	4850lm/39W	7050lm/58W

L mm	Lumen/Watt Medium Power	Lumen/Watt High Power
600	940lm/13W	1360lm/19W
890	1400lm/19W	2040lm/28W
1182	1870lm/24W	2720lm/36W
1475	2340lm/29W	3400lm/44W
1765	2810lm/34W	4080lm/52W
2055	3270lm/39W	4760lm/58W

L mm	Lumen/Watt Medium Power	Lumen/Watt High Power
600	780lm/11W	1070lm/15W
890	1170lm/16W	1600lm/21W
1182	1560lm/20W	2140lm/27W
1475	1950lm/24W	2670lm/33W
1765	2340lm/28W	3210lm/39W
2055	2730lm/31W	3740lm/44W

Lumen Values: Luminaire luminous flux at 4000K/CRI>80. Other configurations on request.





# MATRIC 81 MM SURFACE | A5

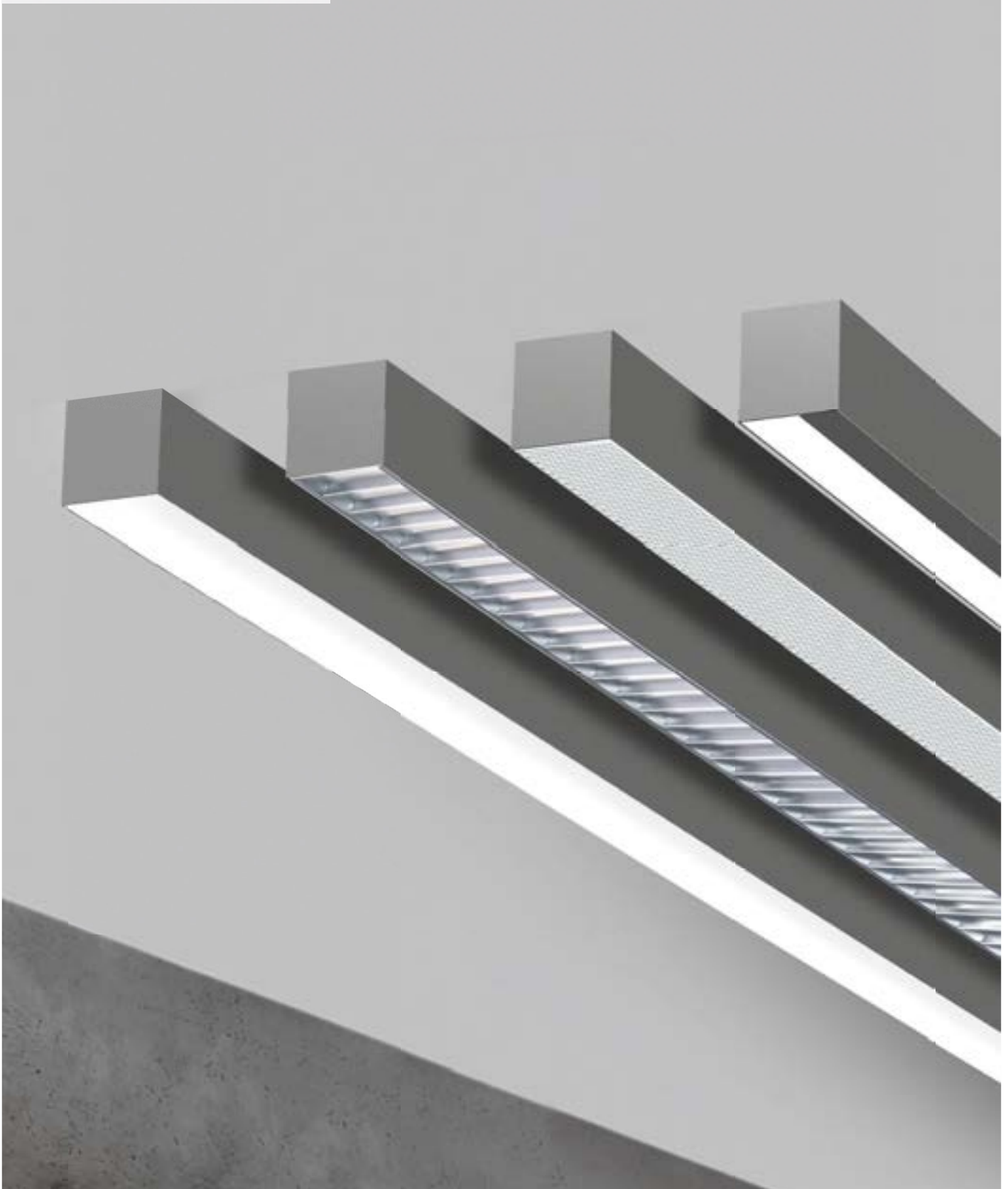

**DE** LED-Anbauleuchte. Rein direktstrahlend. Lichtkanal aus Aluminiumprofil mit 81mm Lichtspur-Breite. Millimetergenaue Längenfertigung nach Vorgabe möglich. Oberfläche naturelxiert oder weiß, graphit, schwarz, champagner oder kupferfarben lackiert. Weitere Oberflächenoptionen siehe Lightnet-Surface-Collection oder RAL nach Wahl. Microprismenoptik und Satin-Louver mit optimierter Blendungsbegrenzung speziell für Office-Anwendungen. Opaldiffusor aus satiniertem Acrylglas für Allgemeinbeleuchtung. Wallwasher für homogene vertikale Beleuchtung. Konverter in Leuchtgehäuse integriert, wahlweise einfach schaltbar oder stufenlos dimmbar (1-10V, DALI, Touch-Dim, Casambi). Farbtemperaturen 2200K, 2700K, 3000K, 3500K, 4000K oder 6500K. Binning initial  $\leq$  MacAdam 3. Farbwiedergabe CRI>80 oder CRI>90. Auf Anfrage: Integration von Notlichtkomponenten, Sensortechnologie sowie Vielzahl weiterer Optionen.

**EN** LED surface-mounted luminaire. Direct only light distribution. Light channel made of aluminium profile with 81mm track width. Precise length production according to specifications possible. Surface natural anodised or white, graphite, black, champagne or copper coated. Further surface options see Lightnet-Surface-Collection or RAL of your choice. Microprismatic and satin louver with optimized glare limitation especially for office purposes. Opal diffuser made of acrylic glass for general lighting. Wallwasher for homogeneous vertical illuminance. Converter integrated into luminaire housing, optionally switchable or dimmable (1-10V, DALI, Touch-Dim, Casambi). Colour temperatures 2200K, 2700K, 3000K, 3500K, 4000K or 6500K. Binning initial  $\leq$  MacAdam 3. Colour rendering CRI>80 or CRI>90. On request: Integration of emergency lighting components, sensor technology as well as many other options.

**FR** Luminaire LED en saillie. Éclairage seulement direct. Rail lumineux en profilé d'aluminium avec une largeur d'éclairage de 81mm. Fabrication au millimètre près des longueurs selon les spécifications. Surface anodisée ou laquée blanc, graphite, noir, champagne ou cuivre. Autres options de finition voir Lightnet-Surface-Collection ou RAL au choix. Diffuseur microprismatique ou Satin-Louver avec une limitation optimisée de l'éblouissement pour les postes de travail. Diffuseur opale en verre acrylique pour éclairage général. Wallwasher pour un éclairage vertical homogène. Driver intégré dans le luminaire, au choix ON/OFF ou graduable (1-10V, DALI, Touch-Dim, Casambi). Température de couleur 2200K, 2700K, 3000K, 3500K, 4000K ou 6500K. Binning initial  $\leq$  MacAdam 3. Rendu de couleur CRI>80 ou CRI>90. Sur demande: Intégration de composants d'éclairage de secours ou de capteurs ainsi qu'une multitude d'autres options.

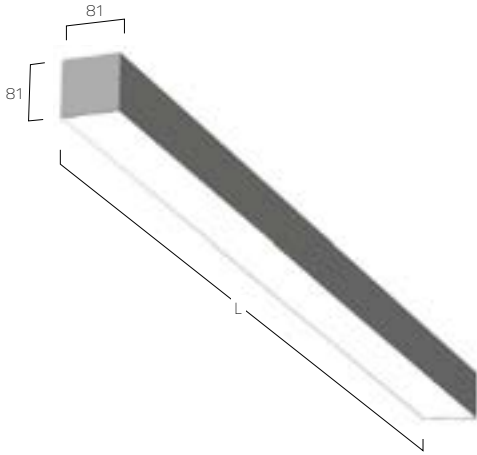

**PRODUCT-CODE:** L A5 A E E - 8 30 M - L890

- PRODUCT FAMILY – L: Matric
- TYPE – A5: Surface Direct Only
- OPTICAL SYSTEM – A: Microprismatic, O: Opal, M: Satin Louver, G: Wallwasher 1, J: Wallwasher 2
- SURFACE FINISH – W: Snow White, E: Silver Anodised, U: Urban Graphite, B: Jet Black, H: Champagne Silver, K: Satin Copper
- CONTROL GEAR – E: On/Off, L: DALI, D: 1-10V, H: Touch-Dim, C: Casambi
- COLOUR REND. – 8: CRI>80, 9: CRI>90, F: Full Spectrum
- COLOUR TEMP. – 22: 2200K, 27: 2700K, 30: 3000K, 35: 3500K, 40: 4000K, 65: 6500K, TW: Tunable White 2700-6500K [L890-L2055]
- POWER – E: Low Power, M: Medium Power, H: High Power
- SIZE – Luminaire length in mm: L600, L890, L1182, L1475, L1765, L2055
- ON REQUEST – Special Length Versions, 90°-Corner, Midpin and Midpoint Spotlights/Downlights, Emergency Module, Multisensor



MICROPRISMATIC

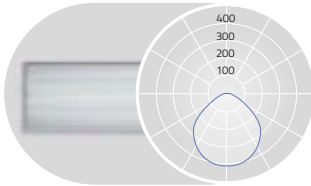

UGR $\leq 19$  for Low Power (X=4H, Y=8H, S=0.25H)  
DIRECT 100%

OPAL

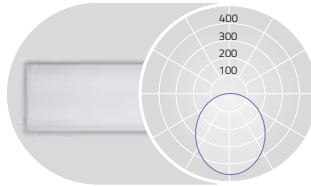

DIRECT 100%

SATIN LOUVER

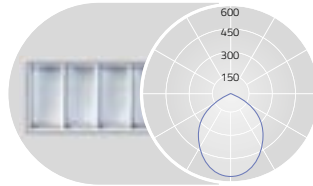

UGR $\leq 19$  for Medium Power (X=4H, Y=8H, S=0.25H)  
DIRECT 100%

WALLWASHER 1

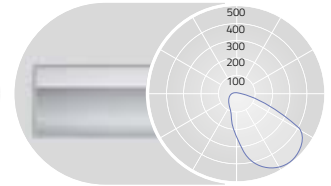

DIRECT 100%

L mm	Lumen/Watt Low Power	Lumen/Watt Medium Power	Lumen/Watt High Power
600	1080lm/10W	1650lm/14W	2190lm/19W
890	1620lm/14W	2470lm/21W	3280lm/29W
1182	2160lm/18W	3290lm/27W	4370lm/38W
1475	2710lm/22W	4110lm/33W	5470lm/46W
1765	3250lm/25W	4940lm/39W	6560lm/54W
2055	3790lm/29W	5760lm/45W	7650lm/61W

L mm	Lumen/Watt Low Power	Lumen/Watt Medium Power	Lumen/Watt High Power
600	1130lm/10W	1720lm/14W	2280lm/19W
890	1690lm/14W	2570lm/21W	3420lm/29W
1182	2260lm/18W	3430lm/27W	4560lm/38W
1475	2820lm/22W	4290lm/33W	5700lm/46W
1765	3390lm/25W	5150lm/39W	6840lm/54W
2055	3950lm/29W	6010lm/45W	7980lm/61W

L mm	Lumen/Watt Medium Power	Lumen/Watt High Power
600	1290lm/14W	1720lm/19W
890	1920lm/21W	2570lm/29W
1182	2550lm/27W	3430lm/38W
1475	3190lm/33W	4290lm/46W
1765	3820lm/39W	5150lm/54W
2055	4450lm/45W	6000lm/61W

L mm	Lumen/Watt High Power
600	1220lm/15W
890	1840lm/21W
1182	2450lm/27W
1475	3060lm/33W
1765	3670lm/39W
2055	4280lm/44W

WALLWASHER 2

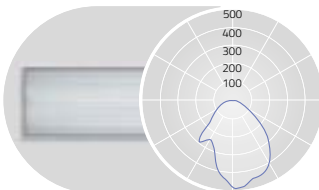

DIRECT: 100%

L mm	Lumen/Watt Medium Power	Lumen/Watt High Power
600	1550lm/14W	2050lm/19W
890	2320lm/21W	3080lm/29W
1182	3090lm/27W	4110lm/38W
1475	3860lm/33W	5130lm/46W
1765	4630lm/39W	6160lm/54W
2055	5410lm/45W	7180lm/61W



90° CORNER  
OPAL / PRISMATIC

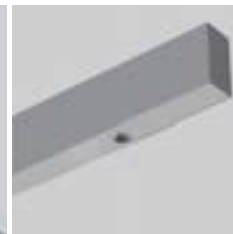

MIDPIN-DOWNLIGHT  
770lm / 11W /  $\varnothing 37$ mm

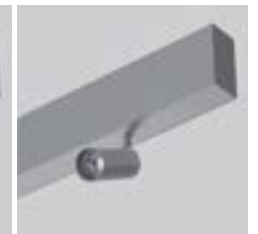

MIDPIN-SINGLE SPOTLIGHT  
770lm / 11W /  $\varnothing 37$ mm



MIDPOINT-SINGLE SPOTLIGHT  
Max. 3000lm/30W/  $\varnothing 90$ mm



MULTISENSOR  
DAYLIGHT & PRESENCE

Lumen Values: Luminaire luminous flux at 4000K/CRI>80. Other configurations on request.

MATRIC 81 MM  
SURFACE | A6



**DE** LED-Anbauleuchte. Rein direktstrahlend. Lichtkanal aus Aluminiumprofil mit 81mm Lichtspur-Breite. Millimetergenaue Längenfertigung nach Vorgabe möglich. Oberfläche naturelxiert oder weiß, graphit, schwarz, champagner oder kupferfarben lackiert. Weitere Oberflächenoptionen siehe Lightnet-Surface-Collection oder RAL nach Wahl. Microprismenoptik mit optimierter Blendungsbegrenzung speziell für Office-Anwendungen. Satiniertes Opaldiffusor für Allgemeinbeleuchtung. Konverter in Leuchtgehäuse integriert, wahlweise einfach schaltbar oder stufenlos dimmbar (1-10V, DALI, Touch-Dim, Casambi). Farbtemperaturen 2200K, 2700K, 3000K, 3500K, 4000K oder 6500K. Binning initial  $\leq$  MacAdam 3. Farbwiedergabe CRI>80 oder CRI>90. Auf Anfrage: Integration von Notlichtkomponenten, Sensortechnologie sowie Vielzahl weiterer Optionen.

**EN** LED surface-mounted luminaire. Direct only light distribution. Light channel made of aluminium profile with 81mm track width. Precise length production according to specifications possible. Surface natural anodised or white, graphite, black, champagne or copper coated. Further surface options see Lightnet-Surface-Collection or RAL of your choice. Microprismatic with optimized glare reduction especially for workplaces. Satin opal diffuser for general lighting. Converter integrated into luminaire housing, optionally switchable or dimmable (1-10V, DALI, Touch-Dim, Casambi). Colour temperatures 2200K, 2700K, 3000K, 3500K, 4000K or 6500K. Binning initial  $\leq$  MacAdam 3. Colour rendering CRI>80 or CRI>90. On request: Integration of emergency lighting components, sensor technology as well as many other options.

**FR** Luminaire LED en saillie. Éclairage seulement direct. Rail lumineux en profilé d'aluminium avec une largeur d'éclairage de 81mm. Fabrication au millimètre près des longueurs selon les spécifications. Surface anodisée ou laquée blanc, graphite, noir, champagne ou cuivre. Autres options de finition voir Lightnet-Surface-Collection ou RAL au choix. Diffuseur microprismatique optimisé pour un éblouissement limité et adapté aux bureaux. Driver intégré dans le luminaire, au choix ON/OFF ou graduable (1-10V, DALI, Touch-Dim, Casambi). Température de couleur 2200K, 2700K, 3000K, 3500K, 4000K ou 6500K. Binning initial  $\leq$  MacAdam 3. Rendu de couleur CRI>80 ou CRI>90. Sur demande: Intégration de composants d'éclairage de secours ou de capteurs ainsi qu'une multitude d'autres options.

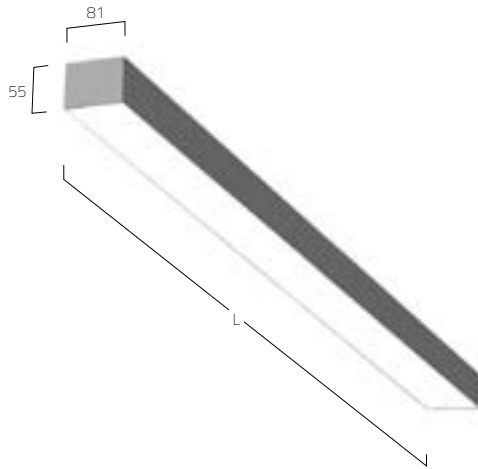

**PRODUCT-CODE:** L A6 A E E - 8 30 M - L890

- PRODUCT FAMILY - L: Matric
- TYPE - A6: Surface Direct Only
- OPTICAL SYSTEM - O: Opal, A: Microprismatic
- SURFACE FINISH - W: Snow White, E: Silver Anodised, U: Urban Graphite, B: Jet Black, H: Champagne Silver, K: Satin Copper
- CONTROL GEAR - E: On/Off, L: DALI, D: 1-10V, H: Touch-Dim, C: Casambi
- COLOUR REND. - 8: CRI>80, 9: CRI>90, F: Full Spectrum
- COLOUR TEMP. - 22: 2200K, 27: 2700K, 30: 3000K, 35: 3500K, 40: 4000K, 65: 6500K, TW: Tunable White 2700-6500K [L890-L2055]
- POWER - E: Low Power, M: Medium Power, H: High Power
- SIZE - Luminaire length in mm: L600, L890, L1182, L1475, L1765, L2055
- ON REQUEST - Special Length Versions, 90°-Corner (Blind), Midpin and Midpoint Spotlights/Downlights, Emergency Module, Multisensor



MICROPRISMATIC

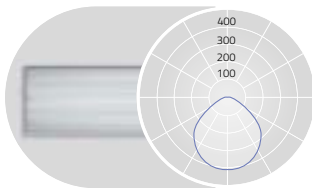

UGR $\leq$ 19 for Low Power (X=4H, Y=8H, S=0.25H)  
DIRECT 100%

OPAL

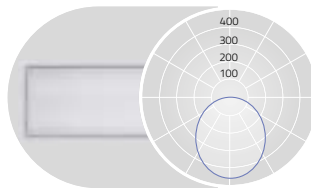

DIRECT 100%

L mm	MICROPRISMATIC			OPAL		
	Lumen/Watt Low Power	Lumen/Watt Medium Power	Lumen/Watt High Power	Lumen/Watt Low Power	Lumen/Watt Medium Power	Lumen/Watt High Power
600	1090lm/10W	1660lm/14W	2210lm/19W	1190lm/10W	1830lm/14W	2440lm/19W
890	1630lm/14W	2490lm/21W	3300lm/29W	1790lm/14W	2740lm/21W	3660lm/29W
1182	2170lm/18W	3320lm/27W	4440lm/37W	2390lm/18W	3650lm/27W	4890lm/37W
1475	2720lm/22W	4150lm/33W	5510lm/45W	2990lm/22W	4570lm/33W	6110lm/45W
1765	3260lm/25W	4980lm/38W	6630lm/53W	3580lm/25W	5480lm/38W	7330lm/53W
2055	3800lm/28W	5810lm/44W	7750lm/60W	4180lm/28W	6390lm/44W	8550lm/60W

Lumen Values: Luminaire luminous flux at 4000K/CRI>80. Other configurations on request.



# VISION SURFACE | A2



**DE** LED-Anbauleuchte. Rein direktstrahlend. Lichtkanal aus Aluminiumprofil mit 130mm Breite. Millimetergenaue Längenfertigung nach Vorgabe möglich. Oberfläche naturreloxiert oder weiß, graphit, schwarz, champagner oder kupferfarben lackiert. Weitere Oberflächenoptionen siehe Lightnet-Surface-Collection oder RAL nach Wahl. Microprismenoptik und Satin Louver für Office-Anwendungen. Opal diffuser made of acrylic glass for general illumination. Wallwasher für homogene vertikale Beleuchtung. Konverter integriert in Leuchtengehäuse integriert, wahlweise einfach schaltbar oder stufenlos dimmbar (1-10V, DALI, Touch-Dim, Casambi). Farbtemperaturen 2200K, 2700K, 3000K, 3500K, 4000K oder 6500K. Binning initial  $\leq$  MacAdam 3. Farbwiedergabe CRI>80 oder CRI>90. Auf Anfrage: Integration von Notlichtkomponenten.

**EN** LED surface-mounted luminaire. Direct only light distribution. Light channel made of aluminium profile with 130mm width. Precise length production according to specifications possible. Surface natural anodised or white, graphite, black, champagne or copper coated. Further surface options see Lightnet-Surface-Collection or RAL of your choice. Microprismatic and satin louver for office purposes. Opal diffuser made of acrylic glass for general illumination. Wallwasher for homogeneous vertical illuminance. Converter integrated into luminaire housing, optionally switchable or dimmable (1-10V, DALI, Touch-Dim, Casambi). Colour temperatures 2200K, 2700K, 3000K, 3500K, 4000K or 6500K. Binning initial  $\leq$  MacAdam 3. Colour rendering CRI>80 or CRI>90. On request: Integration of emergency lighting components.

**FR** Luminaire LED en saillie. Éclairage seulement direct. Rail lumineux en profilé d'aluminium avec largeur de 130mm. Fabrication au millimètre près des longueurs selon les spécifications. Surface anodisée ou laquée blanc, graphite, noir, champagne ou cuivre. Autres options de finition voir Lightnet-Surface-Collection ou RAL au choix. Optique microprismatique et satin louver pour postes de travail. Diffuseur opale en verre acrylique pour éclairage général. Wallwasher pour un éclairage vertical homogène. Driver intégré dans le luminaire, au choix ON/OFF ou graduable (1-10V, DALI, Touch-Dim, Casambi). Température de couleur 2200K, 2700K, 3000K, 3500K, 4000K ou 6500K. Binning initial  $\leq$  MacAdam 3. Rendu de couleur CRI>80 ou CRI>90. Sur demande: Intégration de composants d'éclairage de secours.



**PRODUCT-CODE:** VA2 A E E - 8 30 M - L890

PRODUCT FAMILY	- V: Vision
TYPE	- A2 Surface Direct Only
OPTICAL SYSTEM	- O: Opal, A: Microprismatic, M: Satin Louver, G: Wallwasher
SURFACE FINISH	- W: Snow White, E: Silver Anodised, U: Urban Graphite, B: Jet Black, H: Champagne Silver, K: Satin Copper
CONTROL GEAR	- E: On/Off, L: DALI, D: 1-10V, H: Touch-Dim, C: Casambi
COLOUR REND.	- 8: CRI>80, 9: CRI>90, F: Full Spectrum
COLOUR TEMP.	- 22: 2200K, 27: 2700K, 30: 3000K, 35: 3500K, 40: 4000K, 65: 6500K, TW: Tunable White 2700-6500K
POWER	- M: Medium Power, H: High Power
SIZE	- Luminaire length in mm: L890, L1182, L1475, L1765, L2055
ON REQUEST	- Special Length Versions, 90°-Corner, Midpin Spotlights/Downlights, Emergency Module, Multisensor

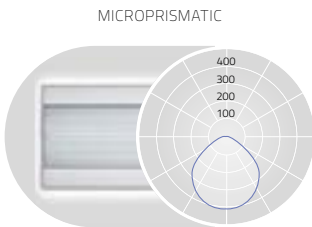

DIRECT 100%

L mm	Lumenlm/Watt Medium Power	Lumenlm/Watt High Power
890	2820lm/33W	3650lm/44W
1182	3760lm/42W	4870lm/57W
1475	4700lm/51W	6080lm/69W
1765	5640lm/60W	7300lm/81W
2055	6580lm/75W	8520lm/101W

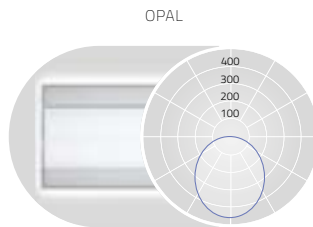

DIRECT 100%

L mm	Lumenlm/Watt Medium Power	Lumenlm/Watt High Power
890	3040lm/33W	3930lm/44W
1182	4050lm/42W	5240lm/57W
1475	5060lm/51W	6560lm/69W
1765	6080lm/60W	7870lm/81W
2055	7090lm/75W	9180lm/101W

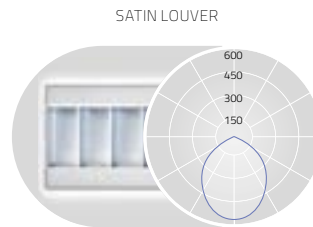

DIRECT 100%

L mm	Lumenlm/Watt Medium Power	Lumenlm/Watt High Power
890	3170lm/33W	4110lm/44W
1182	4230lm/42W	5480lm/57W
1475	5290lm/51W	6850lm/69W
1765	6350lm/60W	8220lm/81W
2055	7400lm/75W	9590lm/101W

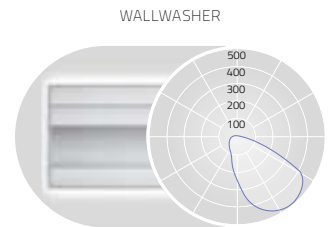

DIRECT 100%

L mm	Lumenlm/Watt Medium Power	Lumenlm/Watt High Power
890	1340lm/16W	1840lm/21W
1182	1780lm/20W	2450lm/27W
1475	2230lm/24W	3060lm/33W
1765	2670lm/28W	3670lm/39W
2055	3120lm/31W	4280lm/44W

Lumen Values: Luminaire luminous flux at 4000K/CRI>80. Other configurations on request.





MIDPIN RECESSED | M2 416



MIDPOINT SEMI-RECESSED | E6 418



MIDPOINT RECESSED | F7 420



MIDPOINT RECESSED | M6 422



MIDPOINT RECESSED | K6 424



MIDPOINT RECESSED | D6 430



BASIC SUPERFLAT SEMI-RECESSED | L7 432



BASIC MAX RECESSED AURA | N1 434



BASIC MAX RECESSED FRAMELESS | M2 440



BASIC MAX RECESSED FRAME | M4 442



BASIC MAX RECESSED MODULE | M8 446



RINGO STAR 100MM RECESSED | F1 448



LIQUID LINE RECESSED | F3 458

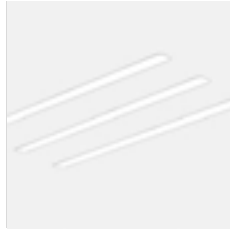

CALEO LINEAR RECESSED | L3 460



CALEO RECESSED | M2 462



CUBIC MAX RECESSED FRAMELESS | M2 466



CUBIC MAX RECESSED FRAME | M4 468



CUBIC AMBIENT SEMI-RECESSED | M7 470



CUBIC MAX RECESSED MODULE | M8 476



CUBIC MAX RECESSED MODULE | M9 478



MATRIC 38MM RECESSED FRAMELESS | M1 484



MATRIC 38MM LENS LOUVER RECESSED FRAME | F1 486



MATRIC 38MM RECESSED FRAME | F1 488



MATRIC 55MM RECESSED FRAMELESS | M3 490



MATRIC 55MM RECESSED FRAME | F3 492



MATRIC 81MM RECESSED FRAME | F5 496



MIDPOINT  
RECESSED | O6 426



BASIC AMBIENT  
SEMI-RECESSED | M6 444



CUBIC MAX  
RECESSED AURA | N2 464



MATRIC 38MM LENS LOUVER  
RECESSED FRAMELESS | M1 482



MATRIC 81MM  
RECESSED FRAMELESS | M5 494

—■— EINBAU | RECESSED | ENCASTRÉ



MIDPIN  
RECESSED | M2



**DE** LED-Einbaustrahler mit umlaufendem Rahmen für Montage in gesägten Deckenöffnungen. Rein direktstrahlend. Oberfläche schwarz oder weiß lackiert. 350° drehbar und 90° schwenkbar. Farbtemperaturen wahlweise 2700K, 3000K oder 4000K. Binning initial ≤ MacAdam 3. Farbwiedergabe CRI>90. Austauschbare Linsenoptiken mit Ausstrahlwinkel 20° (Spot), 30° (Medium) oder 40° (Flood). Separater Konverter im Lieferumfang enthalten, wahlweise einfach schaltbar oder stufenlos dimmbar (DALI).

**EN** LED recessed spotlight with surrounding frame for installation in ceilings with cut-out openings. Direct only light distribution. Surface black or white coated. 350° rotatable and 90° tiltable. Colour temperatures optionally 2700K, 3000K or 4000K. Binning initial ≤ MacAdam 3. Colour rendering CRI>90. Changeable lens optics with beam angle 20° (spot), 30° (medium) or 40° (flood). Separate converter included, optionally switchable or dimmable (DALI).

**FR** Spot LED encastré LED avec cadre-colerette pour montage dans plafonds à découpes. Éclairage seulement direct. Surface laquée noir ou blanc. Orientable à 350° et pivotant à 90°. Température de couleur 2700K, 3000K ou 4000K. Binning initial ≤ MacAdam 3. Rendu de couleur CRI>90. Optique de lentilles interchangeables avec faisceau/angle d'ouverture 20° (spot), 30° (medium) ou 40° (flood). Convertisseur inclus mais livré séparément, au choix avec alimentation simple ON/OFF ou dimmable (DALI).



**PRODUCT-CODE:** **D M2 A B E - 9 27 M**

PRODUCT FAMILY	- D: Midpin
TYPE	- M2: Recessed
BEAM ANGLE	- A: Spot 20°, B: Medium 30°, C: Flood 40°
SURFACE FINISH	- W: Snow White, B: Jet Black
CONTROL GEAR	- E: On/Off, L: DALI
COLOUR RENDER.	- 9: CRI>90
COLOUR TEMP.	- 27: 2700K, 30: 3000K, 40: 4000K
POWER	- M: Medium Power



SPOT 20° LED ENGINE ECO, MEDIUM POWER

Mounting Height	Average Illuminance [Lux] center/side	Beam Diameter
1 m	3700/1756	0.41 m
2 m	925/439	0.83 m
3 m	411/195	1.20 m
4 m	231/110	1.70 m

LED Engine	2700K	3000K	3500K	4000K
11,0W	620	720	760	760

MEDIUM 30° LED ENGINE ECO, MEDIUM POWER

Mounting Height	Average Illuminance [Lux] center/side	Beam Diameter
1 m	2079/929	0.57 m
2 m	520/232	1.10 m
3 m	231/103	1.70 m
4 m	130/58	2.30 m

LED Engine	2700K	3000K	3500K	4000K
11,0W	610	710	750	750

FLOOD 40° LED ENGINE ECO, MEDIUM POWER

Mounting Height	Average Illuminance [Lux] center/side	Beam Diameter
1 m	1454/591	0.77 m
2 m	364/148	1.50 m
3 m	162/66	2.30 m
4 m	91/37	3.10 m

LED Engine	2700K	3000K	3500K	4000K
11,0W	620	730	770	770

MIDPOINT  
SEMI-RECESSED | E6



**DE** LED-Einbaustrahler für gesägte Deckenöffnungen. 350° drehbar und 90° schwenkbar. LED Engine wahlweise XICATO ARTIST für höchste Lichtqualität mit bester Farbwiedergabe und 5 Jahre Garantie für Farbkonstanz (MacAdams $\leq$ 3) oder ECO für höchste Energieeffizienz bei optimalem Preis-Leistungsverhältnis und CRI>90. Farbtemperaturen 2700K, 3000K oder 4000K. Austauschbare Linsen-Reflektoroptiken mit sphärischer Facettenoptik. Ausstrahlwinkel: 10° (Spot), 20° (Medium), 35° (Flood) oder 50° (Wide Flood). Separater Konverter im Lieferumfang enthalten, wahlweise einfach schaltbar oder stufenlos dimmbar (DALI). Standardmäßig klare Abdeckung. Optional zusätzliche Filter oder Wabenraster. Gehäuse aus Aluminium in weiß, silber, schwarz oder champagnerfarben lackiert. Reflektoring zusätzlich in gold- oder kupferfarben erhältlich.

**EN** LED recessed spotlight for ceilings with cut-out openings. 350° rotatable and 90° tiltable. LED Engine with XICATO ARTIST for highest light quality and colour rendering, including 5 year warranty for colour consistency (MacAdams 3). Alternatively ECO for highest energy efficiency with optimal price-performance ratio and CRI > 90. Colour temperature 2700K, 3000K or 4000K. Replaceable lens reflector optics with spherical faceted optics. Beam angle: 10° (Spot), 20° (Medium), 35° (Flood) or 50° (Wide Flood). Separate Driver included, optionally switchable or dimmable (DALI). Standard clear cover. Optional additional filters or honeycomb grid. Housing made of white, silver, black or champagne coated aluminum. Reflector ring also available in gold or copper colours.

**FR** Spot LED encastré pour plafonds avec ouvertures sciées. Orientable à 350° et pivotant à 90°. Module/COB LED XICATO ARTIST en option pour une qualité d'éclairage maximale et un rendu des couleurs exceptionnel + 5 ans de garantie sur le niveau des couleurs (MacAdams 3) ou ECO pour une efficacité énergétique et un rapport qualité-prix optimal + IRC supérieur à 90 inclus. Température de couleur 2700K, 3000K ou 4000K. Réflecteur avec optique de lentille interchangeable et facettes de réflexion sphérique. Angle d'ouverture/faisceau: 10° (Spot), 20° (Medium), 35° (Flood) ou 50° (Wide Flood). Convertisseur inclus mais livré séparément, au choix avec alimentation simple ON/OFF ou dimmable (DALI). Verre de protection et de fermeture standard. Filtres divers supplémentaires et/ou filtre nid d'abeilles en option. Boîtier en aluminium couleurs blanc, argent, noir ou titane laqué.



**PRODUCT-CODE:** P E 6 B S E - 9 27 F M - B K

- PRODUCT FAMILY - P: Midpoint
- TYPE - E6: Recessed
- BEAM ANGLE - A: Spot 10°, B: Medium 20°, C: Flood 35°, D: Wide Flood 50°
- SURFACE FINISH - W: Snow White, V: Ivory White, S: Radiant Silver, B: Jet Black, H: Champagne Silver
- CONTROL GEAR - E: On/Off, L: DALI
- COLOUR RENDER. - 9: CRI>90
- COLOUR TEMP. - 27: 2700K, 30: 3000K, 40: 4000K
- LED-ENGINE - F: Eco [Ra > 90], A: Artist [Ra > 97, Xicato]
- POWER - E: Low Power M: Medium Power
- OPTIC RING - W: Snow White, V: Ivory White, S: Radiant Silver, B: Jet Black, H: Champagne Silver, G: Satin Gold, K: Satin Copper
- COVER - K: Clear Cover [Standard], P: Prismatic Lens, H: Honeycomb Louver, B: Dichroic Filter [Bread], M: Dichroic Filter [Meat]

**SPOT 10° LED ENGINE ECO, MEDIUM POWER**

Mounting Height	Illuminance [Lux] center/side	Beam Diameter
1 m	25250/12700	0.24 m
2 m	6312/3175	0.48 m
3 m	2806/1411	0.72 m
4 m	1578/794	0.95 m

LED Engine	2700K	3000K	4000K
Eco Low Power [20W]	1230	1350	1440
Eco Medium Power [31W]	1660	1860	2020
Artist Low Power [21W]	1040	1090	1190
Artist Medium Power [33W]	1400	1480	1560

**MEDIUM 20° LED ENGINE ECO, MEDIUM POWER**

Mounting Height	Illuminance [Lux] center/side	Beam Diameter
1 m	17447/8455	0.32 m
2 m	4362/2114	0.64 m
3 m	1939/939	0.96 m
4 m	1090/528	1.30 m

LED Engine	2700K	3000K	4000K
Eco Low Power [20W]	1580	1740	1850
Eco Medium Power [31W]	2360	2640	2870
Artist Low Power [21W]	1330	1390	1510
Artist Medium Power [33W]	1980	2110	2220

**FLOOD 35° LED ENGINE ECO, MEDIUM POWER**

Mounting Height	Illuminance [Lux] center/side	Beam Diameter
1 m	6251/2731	0.63 m
2 m	1563/683	1.30 m
3 m	695/303	1.90 m
4 m	391/171	2.50 m

LED Engine	2700K	3000K	4000K
Eco Low Power [20W]	1530	1680	1790
Eco Medium Power [31W]	2280	2550	2780
Artist Low Power [21W]	1290	1350	1470
Artist Medium Power [33W]	1930	2060	2160

**WIDE FLOOD 50° LED ENGINE ECO, MEDIUM POWER**

Mounting Height	Illuminance [Lux] center/side	Beam Diameter
1 m	3550/1319	0.94 m
2 m	887/330	1.90 m
3 m	394/147	2.80 m
4 m	222/82	3.80 m

LED Engine	2700K	3000K	4000K
Eco Low Power [20W]	1440	1580	1680
Eco Medium Power [31W]	2230	2490	2710
Artist Low Power [21W]	1250	1310	1430
Artist Medium Power [33W]	1910	2040	2140

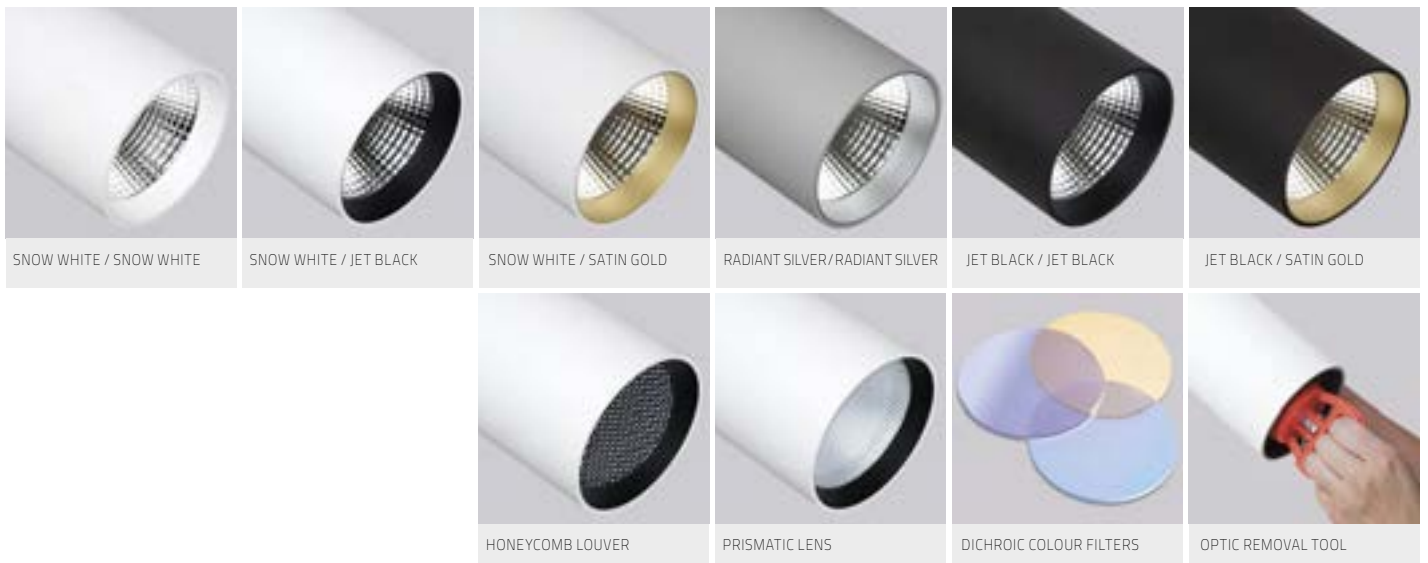

MIDPOINT  
RECESSED | F7



**DE** LED-Einbaustrahler mit umlaufendem Rahmen für Montage in gesägten Deckenöffnungen. LED Engine wahlweise XICATO ARTIST für höchste Lichtqualität mit bester Farbwiedergabe und 5 Jahre Garantie für Farbkonstanz (MacAdams $\leq$ 3) oder ECO für höchste Energieeffizienz bei optimalem Preis-Leistungsverhältnis und CRI>90. Farbtemperaturen 2700K, 3000K oder 4000K. Austauschbare Linsen-Reflektoroptiken mit sphärischer Facettenoptik. Ausstrahlwinkel: 10° (Spot), 20° (Medium), 35° (Flood) oder 50° (Wide Flood). Separater Konverter im Lieferumfang enthalten, wahlweise einfach schaltbar oder stufenlos dimmbar (DALI). Standardmäßig klare Abdeckung. Optional zusätzliche Filter oder Wabenraster. Gehäuse aus Aluminium in weiß, silber, schwarz oder champagnerfarben lackiert. Reflektoring zusätzlich in gold- oder kupferfarben erhältlich.

**EN** LED recessed spotlight with surrounding frame for installation in ceilings with cut-out openings. LED Engine with XICATO ARTIST for highest light quality and colour rendering, including 5 year warranty for colour consistency (MacAdams 3). Alternatively ECO for highest energy efficiency with optimal price-performance ratio and CRI> 90. Colour temperature 2700K, 3000K or 4000K. Replaceable lens reflector optics with spherical faceted optics. Beam angle: 10° (Spot), 20° (Medium), 35° (Flood) oder 50° (Wide Flood). Separate Driver included, optionally switchable or dimmable (DALI). Standard clear cover. Optional additional filters or honeycomb grid. Housing made of white, silver, black or champagne coated aluminum. Reflector ring also available in gold or copper colours.

**FR** Spot LED encastré LED avec cadre-colerette pour montage dans plafonds à découpes. Module/COB LED XICATO ARTIST en option pour une qualité d'éclairage maximale et un rendu des couleurs exceptionnel + 5 ans de garantie sur le niveau des couleurs (MacAdams 3) ou ECO pour une efficacité énergétique et un rapport qualité-prix optimal + IRC supérieur à 90 inclus. Température de couleur 2700K, 3000K ou 4000K. Réflecteur avec optique de lentille interchangeable et facettes de réflexion sphérique. Angle d'ouverture/faisceau: 10° (Spot), 20° (Medium), 35° (Flood) oder 50° (Wide Flood). Convertisseur inclus mais livré séparément, au choix avec alimentation simple ON/OFF ou dimmable (DALI). Verre de protection et de fermeture standard. Filtrés divers supplémentaires et/ou filtre nid d'abeilles en option. Boîtier en aluminium couleurs blanc, argent, noir ou titane laqué. Bague décorative du réflecteur également disponible en or ou en cuivre.



**PRODUCT-CODE:** P F 7 B S E - 9 27 F M - B K

- PRODUCT FAMILY - P: Midpoint
- TYPE - F7: Recessed mounted fix
- BEAM ANGLE - A: Spot 10°, B: Medium 20°, C: Flood 35°, D: Wide Flood 50°
- SURFACE FINISH - W: Snow White, V: Ivory White, S: Radiant Silver, B: Jet Black, H: Champagne Silver
- CONTROL GEAR - E: On/Off, L: DALI
- COLOUR RENDER. - 9: CRI>90
- COLOUR TEMP. - 27: 2700K, 30: 3000K, 40: 4000K
- LED-ENGINE - F: Eco [Ra> 90], A: Artist [Ra> 97, Xicato]
- POWER - E: Low Power M: Medium Power
- OPTIC RING - W: Snow White, V: Ivory White, S: Radiant Silver, B: Jet Black, H: Champagne Silver, G: Satin Gold, K: Satin Copper
- COVER - K: Clear Cover [Standard], P: Prismatic Lens, H: Honeycomb Louver, B: Dichroic Filter [Bread], M: Dichroic Filter [Meat]



**SPOT 10° LED ENGINE ECO, MEDIUM POWER**

Mounting Height	Illuminance [Lux] center/side	Beam Diameter
1 m	25250/12700	0.24 m
2 m	6312/3175	0.48 m
3 m	2806/1411	0.72 m
4 m	1578/794	0.95 m

**MEDIUM 20° LED ENGINE ECO, MEDIUM POWER**

Mounting Height	Illuminance [Lux] center/side	Beam Diameter
1 m	17447/8455	0.32 m
2 m	4362/2114	0.64 m
3 m	1939/939	0.96 m
4 m	1090/528	1.30 m

**FLOOD 35° LED ENGINE ECO, MEDIUM POWER**

Mounting Height	Illuminance [Lux] center/side	Beam Diameter
1 m	6251/2731	0.63 m
2 m	1563/683	1.30 m
3 m	695/303	1.90 m
4 m	391/171	2.50 m

**WIDE FLOOD 50° LED ENGINE ECO, MEDIUM POWER**

Mounting Height	Illuminance [Lux] center/side	Beam Diameter
1 m	3550/1319	0.94 m
2 m	887/330	1.90 m
3 m	394/147	2.80 m
4 m	222/82	3.80 m

LED Engine	2700K	3000K	4000K
Eco Low Power [20W]	1230	1350	1440
Eco Medium Power [31W]	1660	1860	2020
Artist Low Power [21W]	1040	1090	1190
Artist Medium Power [33W]	1400	1480	1560

LED Engine	2700K	3000K	4000K
Eco Low Power [20W]	1580	1740	1850
Eco Medium Power [31W]	2360	2640	2870
Artist Low Power [21W]	1330	1390	1510
Artist Medium Power [33W]	1980	2110	2220

LED Engine	2700K	3000K	4000K
Eco Low Power [20W]	1530	1680	1790
Eco Medium Power [31W]	2280	2550	2780
Artist Low Power [21W]	1290	1350	1470
Artist Medium Power [33W]	1930	2060	2160

LED Engine	2700K	3000K	4000K
Eco Low Power [20W]	1440	1580	1680
Eco Medium Power [31W]	2230	2490	2710
Artist Low Power [21W]	1250	1310	1430
Artist Medium Power [33W]	1910	2040	2140



MIDPOINT  
RECESSED | M6



**DE** LED-Einbaustrahler mit umlaufendem Rahmen für Montage in gesägten Deckenöffnungen. 350° drehbar und 90° schwenkbar. LED Engine wahlweise XICATO ARTIST für höchste Lichtqualität mit bester Farbwiedergabe und 5 Jahre Garantie für Farbkonstanz (MacAdam<sub>3</sub>) oder ECO für höchste Energieeffizienz bei optimalem Preis-Leistungsverhältnis und CRI>90. Farbtemperaturen 2700K, 3000K oder 4000K. Austauschbare Linsen-Reflektoroptiken mit sphärischer Facettenoptik. Ausstrahlwinkel: 10° (Spot), 20° (Medium), 35° (Flood) oder 50° (Wide Flood). Separater Konverter im Lieferumfang enthalten, wahlweise einfach schaltbar oder stufenlos dimmbar (DALI). Standardmäßig klare Abdeckung. Optional zusätzliche Filter oder Wabenraster. Gehäuse und umlaufender Rahmen aus Aluminium in weiß, silber, schwarz oder champagnerfarben lackiert. Reflektorring zusätzlich in gold- oder kupferfarben erhältlich.

**EN** LED recessed spotlight with surrounding frame for installation in ceilings with cut-out openings. 350° rotatable and 90° tilttable. LED Engine with XICATO ARTIST for highest light quality and colour rendering, including 5 year warranty for colour consistency (MacAdams 3). Alternatively ECO for highest energy efficiency with optimal price-performance ratio and CRI> 90. Colour temperature 2700K, 3000K or 4000K. Replaceable lens reflector optics with spherical faceted optics. Beam angle: 10° (Spot), 20° (Medium), 35° (Flood) oder 50° (Wide Flood). Separate Driver included, optionally switchable or dimmable (DALI). Standard clear cover. Optional additional filters or honeycomb grid. Housing and surrounding frame made of aluminium, white, silver, black or champagne coated. Reflector ring also available in gold or copper colours.

**FR** Spot LED encastré LED avec cadre-colerette pour montage dans plafonds à découpes. Orientable à 350° et pivotant à 90°. Module/COB LED XICATO ARTIST en option pour une qualité d'éclairage maximale et un rendu des couleurs exceptionnel + 5 ans de garantie sur le niveau des couleurs (MacAdams 3) ou ECO pour une efficacité énergétique et un rapport qualité-prix optimal + IRC supérieur à 90 inclus. Température de couleur 2700K, 3000K ou 4000K. Réflecteur avec optique de lentille interchangeable et facettes de réflexion sphérique. Angle d'ouverture/faisceau: 10° (Spot), 20° (Medium), 35° (Flood) oder 50° (Wide Flood). Convertisseur inclus mais livré séparément, au choix avec alimentation simple ON/OFF ou dimmable (DALI). Verre de protection et de fermeture standard. Filtres divers supplémentaires et/ou filtre nid d'abeilles en option.

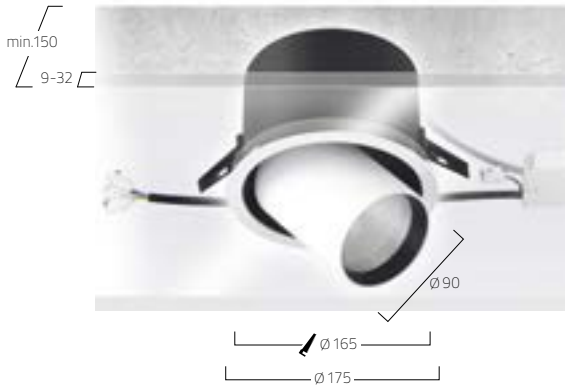

**PRODUCT-CODE:** **P M 6 B S E - 9 27 F M - B K**

PRODUCT FAMILY	- P: Midpoint
TYPE	- M6 Recessed
BEAM ANGLE	- A: Spot 10°, B: Medium 20°, C: Flood 35°, D: Wide Flood 50°
SURFACE FINISH	- W: Snow White, V: Ivory White, S: Radiant Silver, B: Jet Black, H: Champagne Silver
CONTROL GEAR	- E: On/Off, L: DALI
COLOUR RENDER.	- 9: CRI>90
COLOUR TEMP.	- 27: 2700K, 30: 3000K, 40: 4000K
LED-ENGINE	- F: Eco [Ra> 90], A: Artist [Ra> 97, Xicato]
POWER	- E: Low Power M: Medium Power
OPTIC RING	- W: Snow White, V: Ivory White, S: Radiant Silver, B: Jet Black, H: Champagne Silver, G: Satin Gold, K: Satin Copper
COVER	- K: Clear Cover [Standard], P: Prismatic Lens, H: Honeycomb Louver, B: Dichroic Filter [Bread], M: Dichroic Filter [Meat]

**SPOT 10° LED ENGINE ECO, MEDIUM POWER**

Mounting Height	Illuminance [Lux] center/side	Beam Diameter
1 m	25250/12700	0.24 m
2 m	6312/3175	0.48 m
3 m	2806/1411	0.72 m
4 m	1578/794	0.95 m

LED Engine	2700K	3000K	4000K
Eco Low Power [20W]	1230	1350	1440
Eco Medium Power [31W]	1660	1860	2020
Artist Low Power [21W]	1040	1090	1190
Artist Medium Power [33W]	1400	1480	1560

**MEDIUM 20° LED ENGINE ECO, MEDIUM POWER**

Mounting Height	Illuminance [Lux] center/side	Beam Diameter
1 m	17447/8455	0.32 m
2 m	4362/2114	0.64 m
3 m	1939/939	0.96 m
4 m	1090/528	1.30 m

LED Engine	2700K	3000K	4000K
Eco Low Power [20W]	1580	1740	1850
Eco Medium Power [31W]	2360	2640	2870
Artist Low Power [21W]	1330	1390	1510
Artist Medium Power [33W]	1980	2110	2220

**FLOOD 35° LED ENGINE ECO, MEDIUM POWER**

Mounting Height	Illuminance [Lux] center/side	Beam Diameter
1 m	6251/2731	0.63 m
2 m	1563/683	1.30 m
3 m	695/303	1.90 m
4 m	391/171	2.50 m

LED Engine	2700K	3000K	4000K
Eco Low Power [20W]	1530	1680	1790
Eco Medium Power [31W]	2280	2550	2780
Artist Low Power [21W]	1290	1350	1470
Artist Medium Power [33W]	1930	2060	2160

**WIDE FLOOD 50° LED ENGINE ECO, MEDIUM POWER**

Mounting Height	Illuminance [Lux] center/side	Beam Diameter
1 m	3550/1319	0.94 m
2 m	887/330	1.90 m
3 m	394/147	2.80 m
4 m	222/82	3.80 m

LED Engine	2700K	3000K	4000K
Eco Low Power [20W]	1440	1580	1680
Eco Medium Power [31W]	2230	2490	2710
Artist Low Power [21W]	1250	1310	1430
Artist Medium Power [33W]	1910	2040	2140





MIDPOINT  
RECESSED | K6



**DE** LED-Einbaustrahler mit umlaufendem Rahmen für Montage in gesägten Deckenöffnungen. 350° drehbar und 90° schwenkbar. LED Engine wahlweise XICATO ARTIST für höchste Lichtqualität mit bester Farbwiedergabe und 5 Jahre Garantie für Farbkonstanz (MacAdams<sub>3</sub>) oder ECO für höchste Energieeffizienz bei optimalem Preis-Leistungsverhältnis und CRI>90. Farbtemperaturen 2700K, 3000K oder 4000K. Austauschbare Linsen-Reflektoroptiken mit sphärischer Facettenoptik. Ausstrahlwinkel: 10° (Spot), 20° (Medium), 35° (Flood) oder 50° (Wide Flood). Separater Konverter im Lieferumfang enthalten, wahlweise einfach schaltbar oder stufenlos dimmbar (DALI). Standardmäßig klare Abdeckung. Optional zusätzliche Filter oder Wabenraaster. Gehäuse und umlaufender Rahmen aus Aluminium in weiß, silber, schwarz oder champagnerfarben lackiert. Reflektoring zusätzlich in gold- oder kupferfarben erhältlich.

**EN** LED recessed spotlight with surrounding frame for installation in ceilings with cut-out openings. 350° rotatable and 90° tiltable. LED Engine with XICATO ARTIST for highest light quality and colour rendering, including 5 year warranty for colour consistency (MacAdams 3). Alternatively ECO for highest energy efficiency with optimal price-performance ratio and CRI>90. Colour temperature 2700K, 3000K or 4000K. Replaceable lens reflector optics with spherical faceted optics. Beam angle: 10° (Spot), 20° (Medium), 35° (Flood) oder 50° (Wide Flood). Separate Driver included, optionally switchable or dimmable (DALI). Standard clear cover. Optional additional filters or honeycomb grid. Housing and surrounding frame made of aluminium, white, silver, black or champagne coated. Reflector ring also available in gold or copper colours.

**FR** Spot LED encastré LED avec cadre-colerette pour montage dans plafonds à découpes. Orientable à 350° et pivotant à 90°. Module/COB LED XICATO ARTIST en option pour une qualité d'éclairage maximale et un rendu des couleurs exceptionnel + 5 ans de garantie sur le niveau des couleurs (MacAdams 3) ou ECO pour une efficacité énergétique et un rapport qualité-prix optimal + IRC supérieur à 90 inclus. Température de couleur 2700K, 3000K ou 4000K. Réflecteur avec optique de lentille interchangeable et facettes de réflexion sphérique. Angle d'ouverture/faisceau: 10° (Spot), 20° (Medium), 35° (Flood) oder 50° (Wide Flood). Convertisseur inclus mais livré séparément, au choix avec alimentation simple ON/OFF ou dimmable (DALI). Verre de protection et de fermeture standard. Filtrés divers supplémentaires et/ou filtre nid d'abeilles en option. Corps du luminaire/boîtier et colerette en aluminium, couleur blanc, argent, noir ou champagne thermoлаqué.

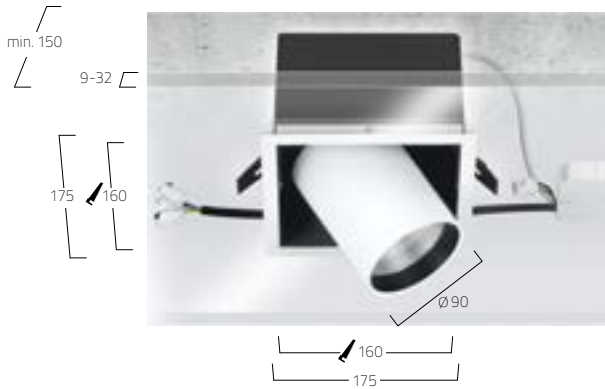

**PRODUCT-CODE:** P K6 B S E - 9 27 F M - B K

PRODUCT FAMILY – P: Midpoint  
 TYPE – K6: Recessed  
 BEAM ANGLE – A: Spot 10°, B: Medium 20°, C: Flood 35°, D: Wide Flood 50°  
 SURFACE FINISH – W: Snow White, V: Ivory White, S: Radiant Silver, B: Jet Black, H: Champagne Silver  
 CONTROL GEAR – E: On/Off, L: DALI  
 COLOUR RENDER – 9: CRI>90  
 COLOUR TEMP. – 27: 2700K, 30: 3000K, 40: 4000K  
 LED-ENGINE – F: Eco [Ra>90], A: Artist [Ra>97, Xicato]  
 POWER – E: Low Power M: Medium Power  
 OPTIC RING – W: Snow White, V: Ivory White, S: Radiant Silver, B: Jet Black, H: Champagne Silver, G: Satin Gold, K: Satin Copper  
 COVER – K: Clear Cover [Standard], P: Prismatic Lens, H: Honeycomb Louver, B: Dichroic Filter [Bread], M: Dichroic Filter [Meat]

**SPOT 10° LED ENGINE ECO, MEDIUM POWER**

Mounting Height	Illuminance [Lux] center/side	Beam Diameter
1 m	25250/12700	0.24 m
2 m	6312/3175	0.48 m
3 m	2806/1411	0.72 m
4 m	1578/794	0.95 m

**MEDIUM 20° LED ENGINE ECO, MEDIUM POWER**

Mounting Height	Illuminance [Lux] center/side	Beam Diameter
1 m	17447/8455	0.32 m
2 m	4362/2114	0.64 m
3 m	1939/939	0.96 m
4 m	1090/528	1.30 m

**FLOOD 35° LED ENGINE ECO, MEDIUM POWER**

Mounting Height	Illuminance [Lux] center/side	Beam Diameter
1 m	6251/2731	0.63 m
2 m	1563/683	1.30 m
3 m	695/303	1.90 m
4 m	391/171	2.50 m

**WIDE FLOOD 50° LED ENGINE ECO, MEDIUM POWER**

Mounting Height	Illuminance [Lux] center/side	Beam Diameter
1 m	3550/1319	0.94 m
2 m	887/330	1.90 m
3 m	394/147	2.80 m
4 m	222/82	3.80 m

LED Engine	2700K	3000K	4000K
Eco Low Power [20W]	1230	1350	1440
Eco Medium Power [31W]	1660	1860	2020
Artist Low Power [21W]	1040	1090	1190
Artist Medium Power [33W]	1400	1480	1560

LED Engine	2700K	3000K	4000K
Eco Low Power [20W]	1580	1740	1850
Eco Medium Power [31W]	2360	2640	2870
Artist Low Power [21W]	1330	1390	1510
Artist Medium Power [33W]	1980	2110	2220

LED Engine	2700K	3000K	4000K
Eco Low Power [20W]	1530	1680	1790
Eco Medium Power [31W]	2280	2550	2780
Artist Low Power [21W]	1290	1350	1470
Artist Medium Power [33W]	1930	2060	2160

LED Engine	2700K	3000K	4000K
Eco Low Power [20W]	1440	1580	1680
Eco Medium Power [31W]	2230	2490	2710
Artist Low Power [21W]	1250	1310	1430
Artist Medium Power [33W]	1910	2040	2140



MIDPOINT  
RECESSED | Q6



**DE** LED-Einbastrahler mit umlaufendem Rahmen für Montage in gesägten Deckenöffnungen. 350° drehbar und 90° schwenkbar. LED Engine wahlweise XICATO ARTIST für höchste Lichtqualität mit bester Farbwiedergabe und 5 Jahre Garantie für Farbkonstanz (Mac Adams 3) oder ECO für höchste Energieeffizienz bei optimalem Preis-Leistungsverhältnis und CRI>90. Farbtemperaturen 2700K, 3000K oder 4000K. Austauschbare Linsen-Reflektoroptiken mit sphärischer Facettenoptik. Ausstrahlwinkel: 10° (Spot), 20° (Medium), 35° (Flood) oder 50° (Wide Flood). Separater Konverter im Lieferumfang enthalten, wahlweise einfach schaltbar oder stufenlos dimmbar (DALI). Standardmäßig klare Abdeckung. Optional zusätzliche Filter oder Wabenraster. Gehäuse und kardanisch umlaufender Rahmen aus Aluminium in weiß, silber, schwarz oder champagnerfarben lackiert. Reflektoring zusätzlich in gold- oder kupferfarben erhältlich.

**EN** LED recessed spotlight with surrounding frame for installation in ceilings with cut-out openings. 350° rotatable and 90° tilttable. LED Engine with XICATO ARTIST for highest light quality and colour rendering, including 5 year warranty for colour consistency (MacAdams 3). Alternatively ECO for highest energy efficiency with optimal price-performance ratio and CRI>90. Colour temperature 2700K, 3000K or 4000K. Replaceable lens reflector optics with spherical faceted optics. Beam angle: 10° (Spot), 20° (Medium), 35° (Flood) oder 50° (Wide Flood). Separate Driver included, optionally switchable or dimmable (DALI). Standard clear cover. Optional additional filters or honeycomb grid. Housing and cardan surrounding frame made of aluminium, white, silver, black or champagne coated. Reflector ring also available in gold or copper colours.

**FR** Spot LED encastré LED avec cadre-colerette pour montage dans plafonds à découpes. Orientable à 350° et pivotant à 90°. Module/COB LED XICATO ARTIST en option pour une qualité d'éclairage maximale et un rendu des couleurs exceptionnel + 5 ans de garantie sur le niveau des couleurs (MacAdams 3) ou ECO pour une efficacité énergétique et un rapport qualité-prix optimal + IRC supérieur à 90 inclus. Température de couleur 2700K, 3000K ou 4000K. Réflecteur avec optique de lentille interchangeable et facettes de réflexion sphérique. Angle d'ouverture/faisceau: 10° (Spot), 20° (Medium), 35° (Flood) oder 50° (Wide Flood). Convertisseur inclus mais livré séparément, au choix avec alimentation simple ON /OFF ou dimmable (DALI). Verre de protection et de fermeture standard. Filtrés divers supplémentaires et/ou filtre nid d'abeilles en option. Corps et cadre cardanique en aluminium laqué blanc, argent, noir ou champagne.

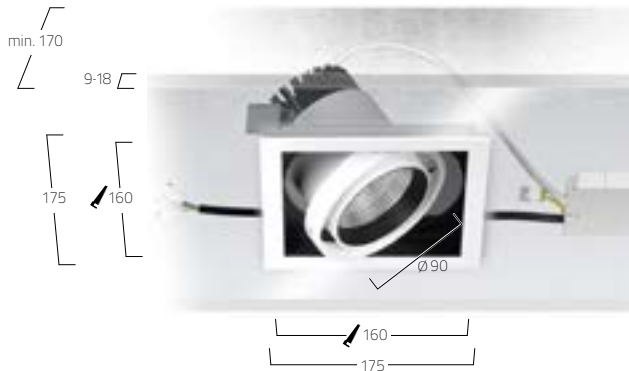

**PRODUCT-CODE:** P Q6 B S E - 9 27 F M - B K

PRODUCT FAMILY	- P: Midpoint
TYPE	- Q6: Recessed
BEAM ANGLE	- A: Spot 10°, B: Medium 20°, C: Flood 35°, D: Wide Flood 50°
SURFACE FINISH	- W: Snow White, V: Ivory White, S: Radiant Silver, B: Jet Black, H: Champagne Silver
CONTROL GEAR	- E: On/Off, L: DALI
COLOUR RENDER	- 9: CRI>90
COLOUR TEMP.	- 27: 2700K, 30: 3000K, 40: 4000K
LED-ENGINE	- F: Eco [Ra>90], A: Artist [Ra>97, Xicato]
POWER	- E: Low Power M: Medium Power
OPTIC RING	- W: Snow White, V: Ivory White, S: Radiant Silver, B: Jet Black, H: Champagne Silver, G: Satin Gold, L: Satin Copper
COVER	- K: Clear Cover [Standard], P: Prismatic Lens, H: Honeycomb Louver, B: Dichroic Filter [Bread], M: Dichroic Filter [Meat]

**SPOT 10° LED ENGINE ECO, MEDIUM POWER**

Mounting Height	Illuminance [Lux] center/side	Beam Diameter
1 m	25250/12700	0.24 m
2 m	6312/3175	0.48 m
3 m	2806/1411	0.72 m
4 m	1578/794	0.95 m

**MEDIUM 20° LED ENGINE ECO, MEDIUM POWER**

Mounting Height	Illuminance [Lux] center/side	Beam Diameter
1 m	17447/8455	0.32 m
2 m	4362/2114	0.64 m
3 m	1939/939	0.96 m
4 m	1090/528	1.30 m

**FLOOD 35° LED ENGINE ECO, MEDIUM POWER**

Mounting Height	Illuminance [Lux] center/side	Beam Diameter
1 m	6251/2731	0.63 m
2 m	1563/683	1.30 m
3 m	695/303	1.90 m
4 m	391/171	2.50 m

**WIDE FLOOD 50° LED ENGINE ECO, MEDIUM POWER**

Mounting Height	Illuminance [Lux] center/side	Beam Diameter
1 m	3550/1319	0.94 m
2 m	887/330	1.90 m
3 m	394/147	2.80 m
4 m	222/82	3.80 m

LED Engine	2700K	3000K	4000K
Eco Low Power [20W]	1230	1350	1440
Eco Medium Power [31W]	1660	1860	2020
Artist Low Power [21W]	1040	1090	1190
Artist Medium Power [33W]	1400	1480	1560

LED Engine	2700K	3000K	4000K
Eco Low Power [20W]	1580	1740	1850
Eco Medium Power [31W]	2360	2640	2870
Artist Low Power [21W]	1330	1390	1510
Artist Medium Power [33W]	1980	2110	2220

LED Engine	2700K	3000K	4000K
Eco Low Power [20W]	1530	1680	1790
Eco Medium Power [31W]	2280	2550	2780
Artist Low Power [21W]	1290	1350	1470
Artist Medium Power [33W]	1930	2060	2160

LED Engine	2700K	3000K	4000K
Eco Low Power [20W]	1440	1580	1680
Eco Medium Power [31W]	2230	2490	2710
Artist Low Power [21W]	1250	1310	1430
Artist Medium Power [33W]	1910	2040	2140



# MIDPOINT RECESSED

CAFE MÉLANIE LAMBERTZ, EUPEN, BELGIUM  
MIDPOINT-Q5





# MIDPOINT RECESSED FRAMELESS | D6



**DE** LED-Einbaustrahler für rahmenlose Montage in Gipskartondecken. Rein direktstrahlend. 350° drehbar und 90° schwenkbar. Leuchtenkörper aus Aluminium. LED Engine wahlweise XICATO ARTIST für höchste Lichtqualität mit bester Farbwiedergabe und 5 Jahre Garantie für Farbkonstanz (MacAdam $\leq$ 3) oder ECO für höchste Energieeffizienz bei optimalem Preis-Leistungsverhältnis und CRI>90. Farbtemperaturen 2700K, 3000K oder 4000K. Austauschbare Linsen-Reflektoroptiken mit sphärischer Facettenoptik. Ausstrahlwinkel: 10° (Spot), 20° (Medium), 35° (Flood) oder 50° (Wide Flood). Separater Konverter im Lieferumfang enthalten, wahlweise einfach schaltbar oder stufenlos dimmbar (DALI). Standardmäßig klare Abdeckung. Optional zusätzliche Filter oder Wabenraster. Äußerer Gehäusering aus Aluminium in weiß, silber, schwarz oder champagnerfarben lackiert. Reflektorring zusätzlich in gold- oder kupferfarben erhältlich.

**EN** LED recessed spotlight for frameless installation in plasterboard ceilings. Direct only light distribution. 350° rotatable and 90° tiltable. Luminaire body made of aluminium. LED Engine with XICATO ARTIST for highest light quality and colour rendering, including 5 year warranty for colour consistency (MacAdams 3). Alternatively ECO for highest energy efficiency with optimal price-performance ratio and CRI> 90. Colour temperature 2700K, 3000K or 4000K. Replaceable lens/reflector optics with spherical faceted optics. Beam angle: 10° (Spot), 20° (Medium), 35° (Flood) oder 50° (Wide Flood). Separate Driver included, optionally switchable or dimmable (DALI). Standard clear cover. Optional additional filters or honeycomb grid. Outer casing ring made of aluminium, white, silver, black or champagne coated. Reflector ring also available in gold or copper colours.

**FR** Spot LED encastré sans cadre pour plafonds en plaqué. Éclairage seulement direct. Orientable à 350° et pivotant à 90°. Corps du luminaire en aluminium. Module/COB LED XICATO ARTIST en option pour une qualité d'éclairage maximale et un rendu des couleurs exceptionnel + 5 ans de garantie sur le niveau des couleurs (Mac Adams 3) ou ECO pour une efficacité énergétique et un rapport qualité-prix optimal + IRC supérieur à 90 inclus. Température de couleur 2700K, 3000K ou 4000K. Réflecteur avec optique de lentille interchangeable et facettes de réflexion sphérique. Angle d'ouverture/faisceau: 10° (Spot), 20° (Medium), 35° (Flood) oder 50° (Wide Flood). Convertisseur inclus mais livré séparément, au choix avec alimentation simple ON/OFF ou dimmable (DALI). Verre de protection et de fermeture standard. Filtrés supplémentaires et/ou filtre nid d'abeilles en option. Bague extérieure en aluminium laquée blanc, argent, noir ou champagne.

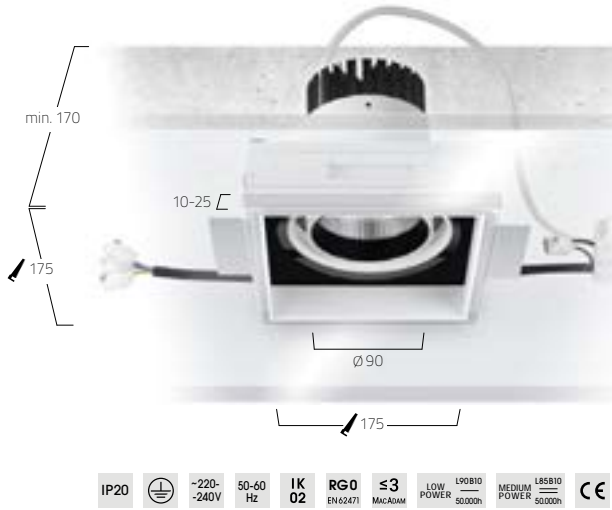

**PRODUCT-CODE:** P D6 B S E - 9 27 F M - B K

PRODUCT FAMILY	- P: Midpoint
TYPE	- D6: Recessed
BEAM ANGLE	- A: Spot 10°, B: Medium 20°, C: Flood 35°, D: Wide Flood 50°
SURFACE FINISH	- W: Snow White, V: Ivory White, S: Radiant Silver, B: Jet Black, H: Champagne Silver
CONTROL GEAR	- E: On/Off, L: DALI
COLOUR RENDER	- 9: CRI>90
COLOUR TEMP.	- 27: 2700K, 30: 3000K, 40: 4000K
LED-ENGINE	- F: Eco [Ra>90], A: Artist [Ra>97, Xicato]
POWER	- E: Low Power M: Medium Power
OPTIC RING	- W: Snow White, V: Ivory White, S: Radiant Silver, B: Jet Black, H: Champagne Silver, G: Satin Gold, K: Satin Copper
COVER	- K: Clear Cover [Standard], P: Prismatic Lens, H: Honeycomb Louver, B: Dichroic Filter [Bread], M: Dichroic Filter [Meat]

**SPOT 10° LED ENGINE ECO, MEDIUM POWER**

Mounting Height	Illuminance [Lux] center/side	Beam Diameter
1 m	25250/12700	0.24 m
2 m	6312/3175	0.48 m
3 m	2806/1411	0.72 m
4 m	1578/794	0.95 m

LED Engine	2700K	3000K	4000K
Eco Low Power [20W]	1230	1350	1440
Eco Medium Power [31W]	1660	1860	2020
Artist Low Power [21W]	1040	1090	1190
Artist Medium Power [33W]	1400	1480	1560

**MEDIUM 20° LED ENGINE ECO, MEDIUM POWER**

Mounting Height	Illuminance [Lux] center/side	Beam Diameter
1 m	17447/8455	0.32 m
2 m	4362/2114	0.64 m
3 m	1939/939	0.96 m
4 m	1090/528	1.30 m

LED Engine	2700K	3000K	4000K
Eco Low Power [20W]	1580	1740	1850
Eco Medium Power [31W]	2360	2640	2870
Artist Low Power [21W]	1330	1390	1510
Artist Medium Power [33W]	1980	2110	2220

**FLOOD 35° LED ENGINE ECO, MEDIUM POWER**

Mounting Height	Illuminance [Lux] center/side	Beam Diameter
1 m	6251/2731	0.63 m
2 m	1563/683	1.30 m
3 m	695/303	1.90 m
4 m	391/171	2.50 m

LED Engine	2700K	3000K	4000K
Eco Low Power [20W]	1530	1680	1790
Eco Medium Power [31W]	2280	2550	2780
Artist Low Power [21W]	1290	1350	1470
Artist Medium Power [33W]	1930	2060	2160

**WIDE FLOOD 50° LED ENGINE ECO, MEDIUM POWER**

Mounting Height	Illuminance [Lux] center/side	Beam Diameter
1 m	3550/1319	0.94 m
2 m	887/330	1.90 m
3 m	394/147	2.80 m
4 m	222/82	3.80 m

LED Engine	2700K	3000K	4000K
Eco Low Power [20W]	1440	1580	1680
Eco Medium Power [31W]	2230	2490	2710
Artist Low Power [21W]	1250	1310	1430
Artist Medium Power [33W]	1910	2040	2140





BASIC SUPERFLAT  
SEMI-RECESSED | L7



**DE** LED-Halbeinbauleuchte für gesägte Deckenöffnungen. Rein direktstrahlend. Umlaufender Einbaurahmen mit lediglich 18mm sichtbarer Bauhöhe. Oberfläche weiß, silber, graphit, schwarz, champagner oder kupferfarben lackiert. Weitere Oberflächenoptionen siehe Lightnet-Surface-Collection oder RAL nach Wahl. Microprismenoptik mit optimierter Blendungsbegrenzung speziell für Office-Anwendungen. Satinierter Opaldiffusor für Allgemeinbeleuchtung mit max. Transmissionsgrad und homogener Lichtpunktauflösung. Konverter in Leuchtgehäuse integriert, wahlweise einfach schaltbar oder stufenlos dimmbar (1-10V, DALI, Touch-Dim, Casambi). Farbtemperaturen 2200K, 2700K, 3000K, 3500K, 4000K oder 6500K. Binning initial  $\leq$  MacAdam 3. Colour rendering CRI>80 oder CRI>90. Recessed luminaire incl. mounting brackets. On request: Integration of emergency lighting components, sensor technology.

**EN** Semi Recessed LED luminaire for ceilings with cut-out openings. Direct only light distribution. Surrounding mounting frame with only 18mm visible overall height. Surface white, silver, graphite, black, champagne or copper coated. Further surface options see Lightnet-Surface-Collection or RAL of your choice. Microprismatic with optimized glare reduction especially for workplaces. Satin opal diffuser for general lighting with maximum transmittance and homogeneous lighting. Converter integrated into luminaire housing, optionally switchable or dimmable (1-10V, DALI, Touch-Dim, Casambi). Colour temperatures 2200K, 2700K, 3000K, 3500K, 4000K or 6500K. Binning initial  $\leq$  MacAdam 3. Colour rendering CRI>80 or CRI>90. Recessed luminaire incl. mounting brackets. On request: Integration of emergency lighting components, sensor technology.

**FR** Luminaire LED semi-encastré avec cadre. Éclairage seulement direct. Cadre de montage périphérique avec une hauteur totale visible de seulement 18 mm. Surface laquée blanc, argent, graphite, noir, champagne ou cuivre. Autres options de finition voir Lightnet-Surface-Collection ou RAL au choix. Diffuseur microprismatique optimisé pour un éblouissement limité et adapté aux bureaux. Diffuseur opale satiné pour un éclairage général et une transmission maximale et homogène. Driver intégré dans le luminaire, au choix ON/OFF ou graduable (1-10V, DALI, Touch-Dim, Casambi). Température de couleur 2200K, 2700K, 3000K, 3500K, 4000K ou 6500K. Binning initial  $\leq$  MacAdam 3. Rendu de couleur CRI>80 ou CRI>90. Luminaire encastré avec kit de fixations inclus. Sur demande: Intégration de composants d'éclairage de secours ou de capteurs.

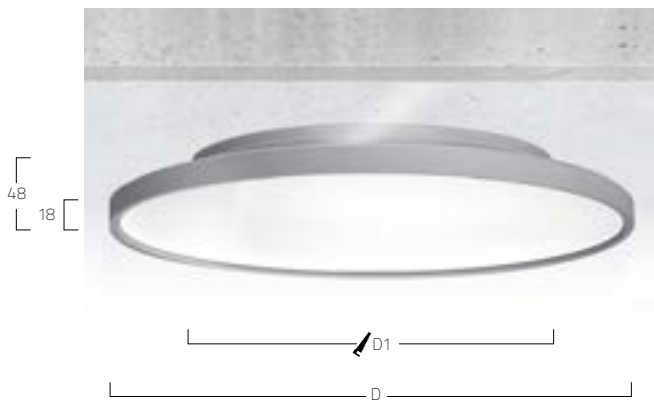

D	D1
300	230
400	320
500	410
600	490
800	670

**PRODUCT-CODE:** B L 7 A S D - 8 30 M - D300

- PRODUCT FAMILY – **B**: Basic
- TYPE – **L7**: Direct Only
- OPTICAL SYSTEM – **A**: Microprismatic, **O**: Opal
- SURFACE FINISH – **W**: Snow White, **V**: Ivory White, **S**: Radiant Silver, **U**: Urban Graphite, **B**: Jet Black, **H**: Champagne Silver, **K**: Satin Copper
- CONTROL GEAR – **E**: On/Off, **L**: DALI, **D**: 1-10V, **H**: Touch-Dim, **C**: Casambi
- COLOUR REND. – **8**: CRI>80, **9**: CRI>90, **F**: Full Spectrum
- COLOUR TEMP. – **22**: 2200K, **27**: 2700K, **30**: 3000K, **35**: 3500K, **40**: 4000K, **65**: 6500K, **TW**: Tunable White 2700-6500K [D400-D800]
- POWER – **M**: Medium Power, **H**: High Power
- SIZE – Luminaire Diameter in mm: **D300**, **D400**, **D500**, **D600**, **D800**
- ON REQUEST – Multisensor, Radar Sensor, Emergency Module

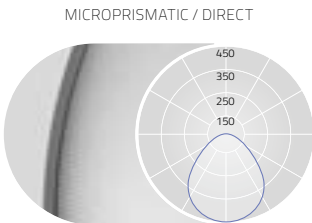

UGRs<19 for Medium Power (X=4H, Y=8H, S=0.25H)  
DIRECT: 100%

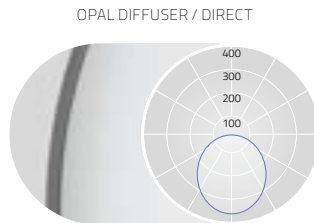

DIRECT: 100%

D mm	Lumen/Watt Medium Power	Lumen/Watt High Power
300	770lm/7W	1320lm/11W
400	1630lm/12W	2670lm/19W
500	2370lm/16W	3970lm/28W
600	3770lm/25W	6130lm/42W
800	5900lm/40W	7920lm/54W

D mm	Lumen/Watt Medium Power	Lumen/Watt High Power
300	780lm/7W	1330lm/11W
400	1650lm/12W	2700lm/19W
500	2410lm/16W	4030lm/28W
600	3840lm/25W	6240lm/42W
800	6040lm/40W	8100lm/54W

Lumen Values: Luminaire luminous flux at 4000K/CRI>80. Other configurations on request.



BASIC MAX  
RECESSED AURA | N1



**DE** LED-Einbauleuchte für rahmenlose Montage in Gipskartondecken. Direktstrahlend mit indirekter Lichtkorona. Leuchtenkörper aus Aluminiumprofil. Oberfläche silber, weiß, graphit, kupfer, champagner oder schwarz lackiert. Weitere Oberflächenoptionen siehe Lightnet-Surface-Collection oder RAL nach Wahl. Microprismenoptik mit optimierter Blendungsbegrenzung speziell für Office-Anwendungen. Satinierter Opaldiffusor für Allgemeinbeleuchtung mit max. Transmissionsgrad und homogener Lichtpunktauflösung. Konverter in Leuchtengehäuse integriert, wahlweise einfach schaltbar oder stufenlos dimmbar (1-10V, DALI, Touch-Dim, Casambi). Farbtemperaturen 2200K, 2700K, 3000K, 3500K, 4000K oder 6500K. Binning initial ≤ MacAdam 3. Farbwiedergabe CRI>80 oder CRI>90. Befestigungsset zur Montage inklusive. Farbliche Auswahl der indirekten Lichtaura in rot, grün, blau und magenta. Auf Anfrage: Integration von Notlichtkomponenten, Sensortechnologie.

**EN** Recessed mounted LED luminaire for frameless installation in plasterboard ceilings. Direct light distribution and indirect lighting corona. Luminaire body made of aluminum profile. Surface silver, white, graphite, copper, champagne or black coated. Further surface options see Lightnet-Surface-Collection or RAL of your choice. Microprismatic screen with optimized glare reduction especially for workplaces. Satin opal diffuser for general lighting with maximum transmittance and homogeneous lighting. Driver integrated into luminaire housing, optionally switchable or dimmable (1-10V, DALI, Touch-Dim, Casambi). Colour temperatures 2200K, 2700K, 3000K, 3500K, 4000K or 6500K. Binning initial ≤ MacAdam 3. Colour rendering CRI>80 or CRI>90. Mounting brackets included. Colour selection for the indirect light aura: red, green, blue and magenta. On request: Integration of emergency lighting components, sensor technology.

**FR** Luminaire LED en saillie pour murs et plafonds. Éclairage direct avec colerette de lumière indirecte ou uniquement éclairage direct. 6 diamètres différents de 300mm à 1200mm. Surface laquée blanc, argent, graphite, noir, champagne ou cuivre. Autres options de finition voir Lightnet-Surface-Collection ou RAL au choix. Diffuseur microprismatique optimisé pour un éblouissement limité et adapté aux bureaux. Diffuseur opale satiné pour un éclairage général et une transmission maximale et homogène. Driver intégré dans le luminaire, au choix ON/OFF ou graduable (1-10V, DALI, Touch-Dim, Casambi). Température de couleur 2200K, 2700K, 3000K, 3500K, 4000K ou 6500K. Binning initial ≤ MacAdam 3. Rendu de couleur CRI>80 ou CRI>90. Sur demande: Intégration de composants d'éclairage de secours ou de capteurs.

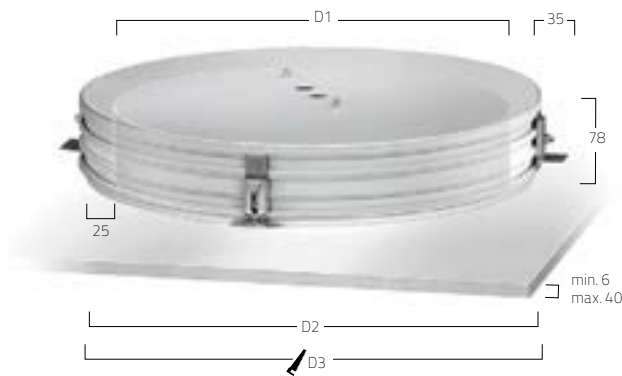

D1 (frame)	D2 (recessed housing)	D3 (cut out)
300	350	368
400	450	468
500	550	568
600	650	668

**PRODUCT-CODE:** **B N1 O B E - 8 30 M - D300 - R**

- PRODUCT FAMILY – **B** Basic
- TYPE – **N1**: Direct with Indirect Corona
- OPTICAL SYSTEM – **A** Microprismatic, **O** Opal
- SURFACE FINISH – **W**: Snow White, **V**: Ivory White, **S**: Radiant Silver, **U**: Urban Graphite, **B**: Jet Black, **H**: Champagne Silver, **K**: Satin Copper \*
- CONTROL GEAR – **E**: On/Off, **L**: DALI, **D**: 1-10V, **H**: Touch-Dim, **C**: Casambi
- COLOUR REND. – **8**: CRI>80, **9**: CRI>90, **F**: Full Spectrum
- COLOUR TEMP. – **22**: 2200K, **27**: 2700K, **30**: 3000K, **35**: 3500K, **40**: 4000K, **65**: 6500K, **TW**: Tunable White 2700-6500K [D400-D600]
- POWER – **E**: Low Power, **M**: Medium Power
- SIZE – Luminaire Diameter in mm: **D300**, **D400**, **D500**, **D600**
- AURA COLOUR – **R**: Red, **G**: Green, **B**: Blue, **M**: Magenta, **W**: White
- ON REQUEST – Emergency Module

\* Housing for frameless installation is always white.



MICROPRISMATIC / DIRECT

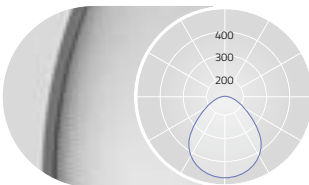

UGR<math>\leq 19</math> for Low Power (X=4H, Y=8H, S=0.25H)  
DIRECT: 100%

OPAL DIFFUSER / DIRECT

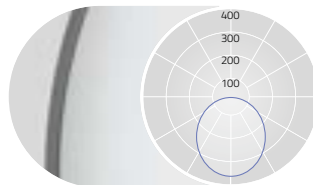

DIRECT: 100%

D mm	Lumen/Watt Low Power	Lumen/Watt Medium Power
300	980lm/12W	1920lm/21W
400	1930lm/19W	3970lm/40W
500	2750lm/26W	5380lm/50W
600	4650lm/52W	8190lm/87W

D mm	Lumen/Watt Low Power	Lumen/Watt Medium Power
300	1000lm/12W	1960lm/21W
400	1970lm/19W	4060lm/40W
500	2810lm/26W	5540lm/50W
600	4820lm/52W	8540lm/87W

Lumen Values: Luminaire luminous flux at 4000K/CRI>80. Other configurations on request.



# BASIC MAX RECESSED





# Netz und Markt

## Zukunft gestalten

Die deutsche Stromwirtschaft ist die modernste und effizienteste der Welt. Das ist ein Ergebnis der hohen Investitionen in die Stromerzeugung, die Netze und die Stromverteilung. Die deutsche Stromwirtschaft ist die modernste und effizienteste der Welt. Das ist ein Ergebnis der hohen Investitionen in die Stromerzeugung, die Netze und die Stromverteilung.

### Stromerzeugung

Die deutsche Stromerzeugung ist die modernste und effizienteste der Welt. Das ist ein Ergebnis der hohen Investitionen in die Stromerzeugung, die Netze und die Stromverteilung. Die deutsche Stromerzeugung ist die modernste und effizienteste der Welt. Das ist ein Ergebnis der hohen Investitionen in die Stromerzeugung, die Netze und die Stromverteilung.

TENNET VIRTUAL VISION - SHOWROOM, BERLIN, GERMANY  
BASIC-M2

# BASIC MAX RECESSED



BIESBOSCH MUSEUM, WERKENDAM, NETHERLANDS  
BASIC-M2 + BASIC-M4<sub>A</sub>  
PHOTOS: RONALD TILLEMANN







BASIC MAX  
RECESSED FRAMELESS | M2



**DE** LED-Einbauleuchte für rahmenlose Montage in Gipskartondecken. Rein direktstrahlend. Leuchtenkörper aus Aluminium. 5 verschiedene Durchmesser von 300 bis 950mm. Microprismenoptik mit optimierter Blendungsbegrenzung speziell für Office-Anwendungen. Satinierter Opaldiffusor für Allgemeinbeleuchtung mit max. Transmissionsgrad und homogener Lichtpunkttauflösung. Konverter in Leuchtgehäuse integriert, wahlweise einfach schaltbar oder stufenlos dimmbar (1-10V, DALI, Touch-Dim, Casambi). Farbtemperaturen 2200K, 2700K, 3000K, 3500K, 4000K oder 6500K. Binning initial  $\leq$  MacAdam 3. Farbwiedergabe CRI>80 oder CRI>90. Befestigungsset zur Montage inklusive. Installationshilfe zur Sicherstellung ordnungsgemäßer Montage empfohlen (s. Zubehör, separat zu ordern). Nicht geeignet für Wandinstallation. Auf Anfrage: Integration von Notlichtkomponenten, Sensortechnologie.

**EN** Recessed mounted LED luminaire for frameless installation in plasterboard ceilings. Direct only light distribution. Luminaire body made of aluminium. 5 different diameters from 300mm to 950mm. Microprismatic with optimized glare reduction especially for workplaces. Satin opal diffuser for general lighting with maximum transmittance and homogeneous lighting. Driver integrated into luminaire housing, optionally switchable or dimmable (1-10V, DALI, Touch-Dim, Casambi). Colour temperatures 2200K, 2700K, 3000K, 3500K, 4000K or 6500K. Binning initial  $\leq$  MacAdam 3. Colour rendering CRI>80 or CRI>90. Mounting brackets included. Mounting template for correct installation is recommended (see accessories, to be ordered separately). Vertical installation not possible. On request: Integration of emergency lighting components, sensor technology.

**FR** Luminaire LED encastré sans cadre pour plafonds en placoplâtre. Éclairage seulement direct. Corps du luminaire en aluminium. 5 diamètres différents de 300mm à 950mm. Diffuseur microprismatique optimisé pour un éblouissement limité et adapté aux bureaux. Diffuseur opale satiné pour un éclairage général et une transmission maximale et homogène. Driver intégré dans le luminaire, au choix ON/OFF ou graduable (1-10V, DALI, Touch-Dim, Casambi). Température de couleur 2200K, 2700K, 3000K, 3500K, 4000K ou 6500K. Binning initial  $\leq$  MacAdam 3. Rendu de couleur CRI>80 ou CRI>90. Support de fixation inclus. Aide d'installation conseillé pour la garantie d'un montage correct (Accessoires, à commander séparément). Pas adapté pour une installation murale. Sur demande: Intégration de composants d'éclairage de secours ou de capteurs.

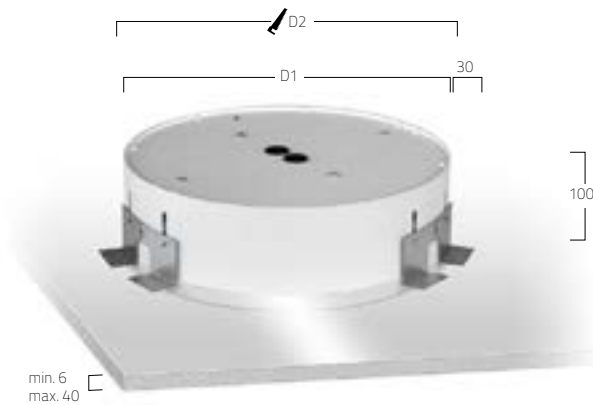

D1 (frame)	D2 (cut out)
300	316
400	416
500	516
650	666
950	966

**PRODUCT-CODE: B M2 OWE - 8 30 M - D300**

PRODUCT FAMILY	- B Basic
TYPE	- M2 Direct Only
OPTICAL SYSTEM	- A Microprismatic [max. D650], O Opal
SURFACE FINISH	- W Snow White
CONTROL GEAR	- E: On/Off, L: DALI, D: 1-10V, H: Touch-Dim, C: Casambi
COLOUR REND.	- 8: CRI>80, 9: CRI>90, F: Full Spectrum
COLOUR TEMP.	- 22: 2200K, 27: 2700K, 30: 3000K, 35: 3500K, 40: 4000K, 65: 6500K, TW: Tunable White 2700-6500K
POWER	- E: Low Power, M: Medium Power
SIZE	- Luminaire Diameter in mm: D300, D400, D500, D650, D950
ON REQUEST	- Radar Sensor, Emergency Module



MICROPRISMATIC / DIRECT

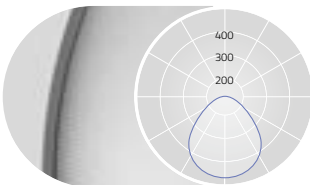

UGR<sub>s</sub>19 for Low Power (X=4H, Y=8H, S=0.25H)  
DIRECT: 100%

OPAL DIFFUSER / DIRECT

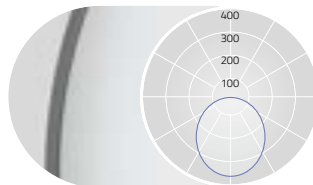

DIRECT: 100%

D mm	Lumen/Watt Low Power	Lumen/Watt Medium Power
300	880lm/8W	1730lm/14W
400	1740lm/13W	3580lm/29W
500	2480lm/18W	4860lm/35W
650	3860lm/28W	7250lm/52W

D mm	Lumen/Watt Low Power	Lumen/Watt Medium Power
300	910lm/8W	1780lm/14W
400	1790lm/13W	3690lm/29W
500	2550lm/18W	5010lm/35W
650	3980lm/28W	7470lm/52W
950	7000lm/59W	11830lm/106W

Lumen Values: Luminaire luminous flux at 4000K/CRI>80. Other configurations on request.

PLEASE ORDER SEPARATELY:

Typ / Type	Code
WT for Basic-M2/Ø300	BM2-WT-300
WT for Basic-M2/Ø400	BM2-WT-400
WT for Basic-M2/Ø500	BM2-WT-500
WT for Basic-M2/Ø650	BM2-WT-650
WT for Basic-M2/Ø950	BM2-WT-950



INSTALLATION TEMPLATE

BASIC MAX  
RECESSED FRAME | M4



**DE** LED-Einbauleuchte mit umlaufendem Rahmen für gesägte Deckenöffnungen. Rein direktstrahlend. Leuchtenkörper aus Aluminium. 7 verschiedene Durchmesser von 220 bis 1250mm. Oberfläche weiß, silber, graphit, schwarz, champagner oder kupferfarben lackiert. Weitere Oberflächenoptionen siehe Lightnet-Surface-Collection oder RAL nach Wahl. Microprismenoptik mit optimierter Blendungsbegrenzung speziell für Office-Anwendungen. Satinierter Opaldiffusor für Allgemeinbeleuchtung mit max. Transmissionsgrad und homogener Lichtpunktauflösung. Konverter in Leuchtgehäuse integriert, wahlweise einfach schaltbar oder stufenlos dimmbar (1-10V, DALI, Touch-Dim). Farbtemperaturen 2200K, 2700K, 3000K, 3500K, 4000K oder 6500K. Binning initial  $\leq$  MacAdam 3. Farbwiedergabe CRI>80 oder CRI>90. Befestigungsset zur Montage inklusive. Nicht geeignet für Wandinstallation. Auf Anfrage: Integration von Notlichtkomponenten, Sensortechnologie, Casambi.

**EN** Recessed mounted LED luminaire with surrounding frame for ceilings with cut-out openings. Direct only light distribution. Luminaire body made of aluminium. 7 different diameters from 220mm to 1250mm. Surface white, silver, graphite, black, champagne or copper coated. Further surface options see Lightnet-Surface-Collection or RAL of your choice. Microprismatic with optimized glare reduction especially for workplaces. Satin opal diffuser for general lighting with maximum transmittance and homogeneous lighting. Converter integrated into luminaire housing, optionally switchable or dimmable (1-10V, DALI, Touch-Dim). Colour temperatures 2200K, 2700K, 3000K, 3500K, 4000K or 6500K. Binning initial  $\leq$  MacAdam 3. Colour rendering CRI>80 or CRI>90. Mounting brackets included. Installation in walls not possible. On request: Integration of emergency lighting components, sensor technology, Casambi.

**FR** Luminaire encastré LED avec cadre périphérique pour un montage sur plafond à ouvertures sciées. Éclairage seulement direct. Corps du luminaire en aluminium. 7 diamètres différents de 220mm à 1250mm. Surface laquée blanc, argent, graphite, noir, champagne ou cuivre. Autres options de finition voir Lightnet-Surface-Collection ou RAL au choix. Diffuseur micro-prismatique optimisé pour un éblouissement limité et adapté aux bureaux. Diffuseur opale satiné pour un éclairage général et une transmission maximale et homogène. Driver intégré dans le luminaire, au choix ON/OFF ou graduable (1-10V, DALI, Touch-Dim). Température de couleur 2200K, 2700K, 3000K, 3500K, 4000K ou 6500K. Binning initial  $\leq$  MacAdam 3. Rendu de couleur CRI>80 ou CRI>90. Support de fixation inclus. Pas adapté pour une installation murale. Sur demande: Intégration de composants d'éclairage de secours ou de capteurs, Casambi.



D1(frame)	D2(cut out)
220	205
320	305
420	405
520	505
670	650
980	960
1250	1230

**PRODUCT-CODE: B M4 O B E - 8 30 M - D320**

- PRODUCT FAMILY - **B** Basic
- TYPE - **M4** Direct Only
- OPTICAL SYSTEM - **A** Microprismatic [max. D670], **O** Opal
- SURFACE FINISH - **W**: Snow White, **V**: Ivory White, **S**: Radiant Silver, **U**: Urban Graphite, **B**: Jet Black, **H**: Champagne Silver, **K**: Satin Copper
- CONTROL GEAR - **E**: On/Off, **L**: DALI, **D**: 1-10V, **H**: Touch-Dim
- COLOUR REND. - **8**: CRI>80, **9**: CRI>90, **F**: Full Spectrum
- COLOUR TEMP. - **22**: 2200K, **27**: 2700K, **30**: 3000K, **35**: 3500K, **40**: 4000K, **65**: 6500K, **TW**: Tunable White 2700-6500K [D320-D1250]
- POWER - **E**: Low Power, **M**: Medium Power
- SIZE - Luminaire Diameter in mm: **D220 D320 D420 D520 D670 D980 D1250**
- ON REQUEST - Radar Sensor, Emergency Module, Casambi



MICROPRISMATIC / DIRECT

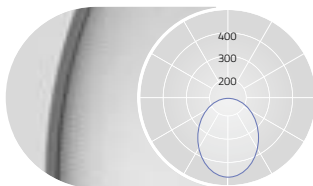

DIRECT: 100%

OPAL DIFFUSER / DIRECT

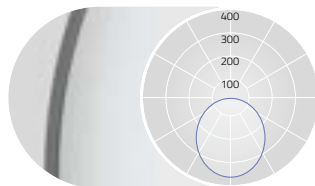

DIRECT: 100%

D mm	Lumen/Watt	
	Low Power	Medium Power
220	540lm/6W	920lm/10W
320	1060lm/8W	1850lm/14W
420	1860lm/13W	4060lm/29W
520	2700lm/18W	5150lm/35W
670	4340lm/28W	7900lm/52W

D mm	Lumen/Watt	
	Low Power	Medium Power
220	510lm/6W	860lm/10W
320	950lm/8W	1820lm/14W
420	1820lm/13W	3800lm/29W
520	2550lm/18W	5010lm/35W
670	3980lm/28W	7470lm/52W
980	6300lm/59W	10650lm/106W
1250	11030lm/107W	18630lm/195W

Lumen Values: Luminaire luminous flux at 4000K/CRI>80. Other configurations on request.



BASIC AMBIENT  
SEMI-RECESSED | M6



**DE** LED-Einbauleuchte mit umlaufendem Rahmen für gesägte Deckenöffnungen. Direkt-rundumstrahlend für dezente Deckenaufhellung. Leuchtenkörper aus Aluminiumprofil. Ambientdiffusor aus satiniertem Acrylglas für Allgemeinbeleuchtung. Oberfläche weiß, silber, graphit, schwarz, champagner oder kupferfarben lackiert. Weitere Oberflächenoptionen siehe Lightnet-Surface-Collection oder RAL nach Wahl. Konverter in Leuchtgehäuse integriert, wahlweise einfach schaltbar oder stufenlos dimmbar (1-10V, DALI, Touch-Dim, Casambi). Farbtemperaturen 2200K, 2700K, 3000K, 3500K, 4000K oder 6500K. Binning initial ≤ MacAdam 3. Farbwiedergabe CRI>80 oder CRI>90. Befestigungsset zur Montage inklusive. Auf Anfrage: Integration von Notlichtkomponenten, Sensortechnologie.

**EN** Recessed mounted LED luminaire with surrounding frame for ceilings with cut-out openings. Omni-directional light distribution for discreet illumination of the ceiling. Luminaire body made of aluminum profile. Ambient diffuser made of frosted acrylic glass for general lighting. Surface white, silver, graphite, black, champagne or copper coated. Further surface options see Lightnet-Surface-Collection or RAL of your choice. Converter integrated into luminaire housing, optionally switchable or dimmable (1-10V, DALI, Touch-Dim, Casambi). Colour temperatures 2200K, 2700K, 3000K, 3500K, 4000K or 6500K. Binning initial ≤ MacAdam 3. Colour rendering CRI>80 or CRI>90. Mounting brackets included. On request: Integration of emergency lighting components, sensor technology.

**FR** Luminaire encastré LED avec cadre périphérique pour un montage sur plafond à ouvertures sciées. Cadre de montage périphérique avec une hauteur totale visible de seulement 18 mm. Corps du luminaire en profilé aluminium. Diffuseur AMBIENT en verre satiné acrylique pour diverses applications d'éclairage. Surface laquée blanc, argent, graphite, noir, champagne ou cuivre. Autres options de finition voir Lightnet-Surface-Collection ou RAL au choix. Driver intégré dans le luminaire, au choix ON/OFF ou graduable (1-10V, DALI, Touch-Dim, Casambi). Température de couleur 2200K, 2700K, 3000K, 3500K, 4000K ou 6500K. Binning initial ≤ MacAdam 3. Rendu de couleur CRI>80 ou CRI>90. Support de fixation inclus. Sur demande: Intégration de composants d'éclairage de secours ou de capteurs.



D1 (frame)	D2 (cut out)
420	405
520	505

**PRODUCT-CODE:** B M6 F B E - 8 30 M - D420

PRODUCT FAMILY	- B: Basic
TYPE	- M6: Direct Only
OPTICAL SYSTEM	- F: Ambient
SURFACE FINISH	- W: Snow White, V: Ivory White, S: Radiant Silver, U: Urban Graphite, B: Jet Black, H: Champagne Silver, K: Satin Copper
CONTROL GEAR	- E: On/Off, L: DALI, D: 1-10V, H: Touch-Dim, C: Casambi
COLOUR REND.	- 8: CRI>80, 9: CRI>90, F: Full Spectrum
COLOUR TEMP.	- 22: 2200K, 27: 2700K, 30: 3000K, 35: 3500K, 40: 4000K, 65: 6500K, TW: Tunable White 2700-6500K
POWER	- M: Medium Power, H: High Power
SIZE	- Luminaire Diameter in mm: D420, D520
ON REQUEST	- Radar Sensor, Emergency Module



AMBIENT DIFFUSER / DIRECT

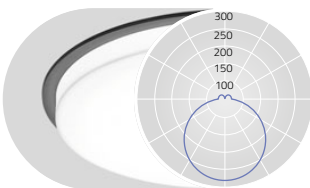

DIRECT: ca. 98% INDIRECT: ca. 2%

D mm	Lumen/Watt Medium Power	Lumen/Watt High Power
420	1830lm/13W	3760lm/26W
520	2600lm/18W	5150lm/36W

Lumen Values: Luminaire luminous flux at 4000K/CRI>80. Other configurations on request.



BASIC MAX  
RECESSED MODULE | M8

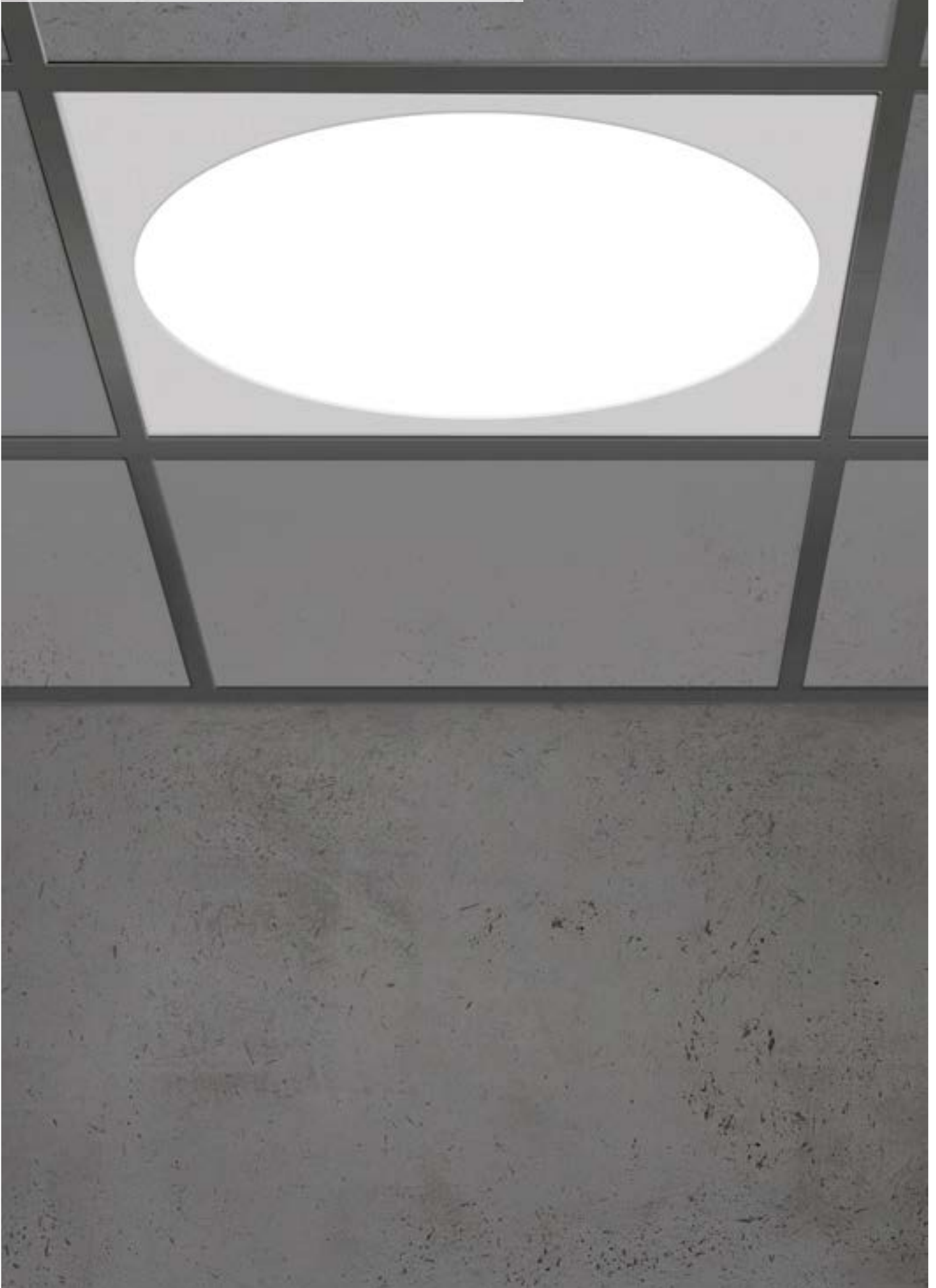

**DE** LED-Einlegeleuchte für Decken mit sichtbaren Tragschienen (Modul 600/625). Rein direktstrahlend. Leuchtenkörper aus Aluminium und Stahlblech. Umlaufender Leuchtenrahmen aus Aluminium, weiß oder silber pulverlackiert. Weitere Oberflächenoptionen siehe Lightnet-Surface-Collection oder RAL nach Wahl. Microprismenoptik mit optimierter Blendungsbegrenzung speziell für Office-Anwendungen. Satinierter Opaldiffusor für Allgemeinbeleuchtung mit max. Transmissionsgrad und homogener Lichtpunktauflösung. Konverter in Leuchtgehäuse integriert, wahlweise einfach schaltbar oder stufenlos dimmbar (1-10V, DALI, Touch-Dim, Casambi). Farbtemperaturen 2200K, 2700K, 3000K, 3500K, 4000K oder 6500K. Binning initial  $\leq$  MacAdam 3. Farbwiedergabe CRI>80 oder CRI>90. Auf Anfrage: Integration von Notlichtkomponenten, Sensortechnologie.

**EN** Recessed mounted LED luminaire for ceilings with exposed grids (Module 600/625). Direct only light distribution. Luminaire body made of aluminium and sheet steel. Surrounding luminaire frame made of aluminium, white or silver powder-coated. Further surface options see Lightnet-Surface-Collection or RAL of your choice. Microprismatic with optimized glare reduction especially for workplaces. Satin opal diffuser for general lighting with maximum transmittance and homogeneous lighting. Converter integrated into luminaire housing, optionally switchable or dimmable (1-10V, DALI, Touch-Dim, Casambi). Colour temperatures 2200K, 2700K, 3000K, 3500K, 4000K or 6500K. Binning initial  $\leq$  MacAdam 3. Colour rendering CRI>80 or CRI>90. On request: Integration of emergency lighting components, sensor technology.

**FR** Luminaire encastré LED pour plafonds avec grilles apparentes (Module 600/625). Éclairage seulement direct. Corps du luminaire en aluminium et acier. Cadre de luminaire périphérique en aluminium, laqué blanc ou argent. Autres options de finition voir Lightnet-Surface-Collection ou RAL au choix. Diffuseur microprismatique optimisé pour un éblouissement limité et adapté aux bureaux. Diffuseur opale satiné pour un éclairage général et une transmission maximale et homogène. Driver intégré dans le luminaire, au choix ON/OFF ou graduable (1-10V, DALI, Touch-Dim, Casambi). Température de couleur 2200K, 2700K, 3000K, 3500K, 4000K ou 6500K. Binning initial  $\leq$  MacAdam 3. Rendu de couleur CRI>80 ou CRI>90. Sur demande: Intégration de composants d'éclairage de secours ou de capteurs.

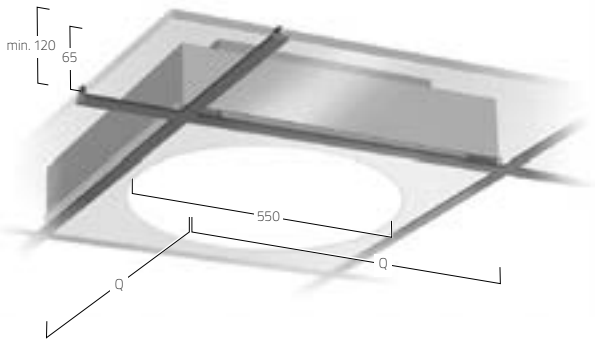

**PRODUCT-CODE: B M8 O W E - 8 30 M - Q597**

- PRODUCT FAMILY – **B**: Basic
- TYPE – **M8**: Direct Only
- OPTICAL SYSTEM – **A**: Microprismatic, **O**: Opal
- SURFACE FINISH – **W**: Snow White, **S**: Radiant Silver
- CONTROL GEAR – **E**: On/Off, **L**: DALI, **D**: 1-10V, **H**: Touch-Dim, **C**: Casambi
- COLOUR REND. – **8**: CRI>80, **9**: CRI>90, **F**: Full Spectrum
- COLOUR TEMP. – **22**: 2200K, **27**: 2700K, **30**: 3000K, **35**: 3500K, **40**: 4000K, **65**: 6500K, **TW**: Tunable White 2700-6500K
- POWER – **E**: Low Power, **M**: Medium Power
- SIZE – Square Size in mm: **Q597** [for Module 600], **Q621** [for Module 625]
- ON REQUEST – Radar Sensor, Emergency Module



MICROPRISMATIC / DIRECT

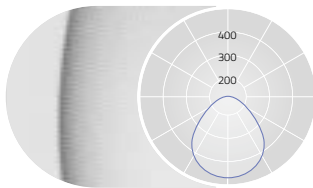

DIRECT: 100%

OPAL DIFFUSER / DIRECT

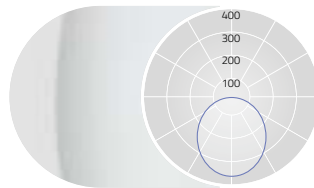

DIRECT: 100%

Q mm	Lumen/Watt Low Power	Lumen/Watt Medium Power
597	4270lm/42W	5990lm/60W
621	4270lm/42W	5990lm/60W

Q mm	Lumen/Watt Low Power	Lumen/Watt Medium Power
597	4780lm/42W	6650lm/60W
621	4780lm/42W	6650lm/60W

Lumen Values: Luminaire luminous flux at 4000K/CRI>80. Other configurations on request.



RINGO STAR 100MM  
RECESSED | F1



**DE** LED-Einbauleuchte mit umlaufendem Rahmen für gesägte Deckenöffnungen. Rein direktstrahlend. Leuchtenkörper aus Aluminiumprofil mit 100mm Lichtspurbreite. 13 verschiedene Durchmesser von 600mm bis 8000mm. Oberfläche silber, weiß, graphit, schwarz, champagner oder kupferfarben lackiert. Weitere Oberflächenoptionen siehe Lightnet-Surface-Collection oder RAL nach Wahl Microprismenoptik mit optimierter Blendungsbegrenzung speziell für Office-Anwendungen. Satinierter Opaldiffusor für Allgemeinbeleuchtung mit max. Transmissionsgrad und homogener Lichtpunktauflösung. Konverter in Leuchtgehäuse integriert, wahlweise einfach schaltbar oder stufenlos dimmbar (1-10V, DALI, Touch-Dim, Casambi). Farbtemperaturen 2200K, 2700K, 3000K, 3500K, 4000K oder 6500K. Binning initial  $\leq$  MacAdam 3. Farbwiedergabe CRI>80 oder CRI>90. Höhenverstellbares Set von Pendelabhängungen zur Montage an Rohbetondecke inklusive.

**EN** Recessed mounted LED luminaire with surrounding frame for ceilings with cut-out openings. Direct only light distribution. Luminaire body made of aluminium profile with 100mm track width. 13 different diameters from 600mm to 8000mm. Surface silver, white, graphite, black, champagne or copper coated. Further surface options see Lightnet-Surface-Collection or RAL of your choice. Microprismatic with optimized glare reduction especially for workplaces. Satin opal diffuser for general lighting with maximum transmittance and homogeneous lighting. Converter integrated into luminaire housing, optionally switchable or dimmable (1-10V, DALI, Touch-Dim, Casambi). Colour temperatures 2200K, 2700K, 3000K, 3500K, 4000K or 6500K. Binning initial  $\leq$  MacAdam 3. Colour rendering CRI>80 or CRI>90. Height-adjustable set of pendant suspensions for mounting on raw concrete ceiling included.

**FR** Luminaire encastré LED avec cadre périphérique pour un montage sur plafond à ouvertures sciées. Éclairage seulement direct. Corps du luminaire en profilé aluminium avec 100mm de largeur du spectre lumineux. 13 diamètres différents de 600mm à 8000mm. Surface laquée argent, blanc, graphite, noir, champagne ou cuivre. Autres options de finition voir Lightnet-Surface-Collection ou RAL au choix. Diffuseur microprismatique optimisé pour un éblouissement limité et adapté aux bureaux. Diffuseur opale satiné pour un éclairage général et une transmission maximale et homogène. Driver intégré dans le luminaire, au choix ON/OFF ou graduable (1-10V, DALI, Touch-Dim, Casambi). Température de couleur 2200K, 2700K, 3000K, 3500K, 4000K ou 6500K. Binning initial  $\leq$  MacAdam 3. Rendu de couleur CRI>80 ou CRI>90. Réglage en hauteur des suspensions pour un montage sur un plafond en béton brut inclus.

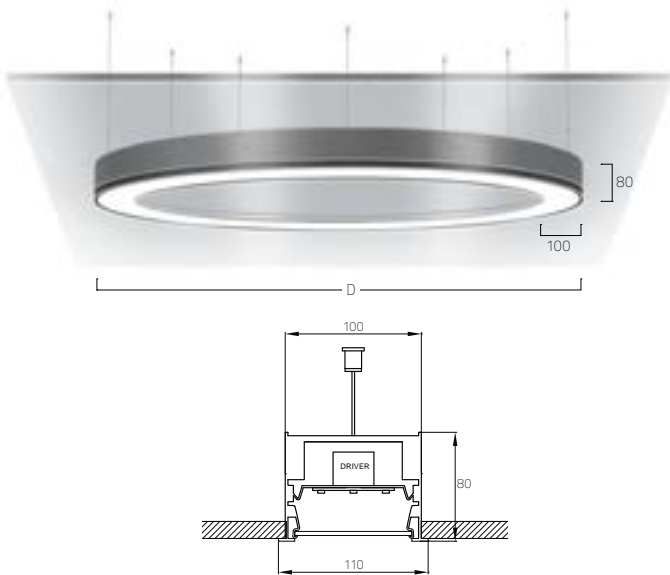

**PRODUCT-CODE:** R F1 O S D - 8 30 M - D1500

- PRODUCT FAMILY - **R** Ringo Star
- TYPE - **F1**: Direct Only
- OPTICAL SYSTEM - **O**: Opal, **A**: Microprismatic
- SURFACE FINISH - **W**: Snow White, **V**: Ivory White, **S**: Radiant Silver, **U**: Urban Graphite, **B**: Jet Black, **H**: Champagne Silver, **K**: Satin Copper
- CONTROL GEAR - **E**: On/Off, **L**: DALI, **D**: 1-10V, **H**: Touch-Dim, **C**: Casambi
- COLOUR REND. - **8**: CRI>80, **9**: CRI>90, **F**: Full Spectrum
- COLOUR TEMP. - **22**: 2200K, **27**: 2700K, **30**: 3000K, **35**: 3500K, **40**: 4000K, **65**: 6500K, **TW**: Tunable White 2700-6500K
- POWER - **E**: Low Power, **M**: Medium Power
- SIZE - Luminaire Diameter in mm: **D600, D900, D1200, D1500, D2000, D2500, D3000, D3500, D4000, D5000, D6000, D7000, D8000**
- ON REQUEST - Emergency Module



MICROPRISMATIC / DIRECT

OPAL DIFFUSER / DIRECT

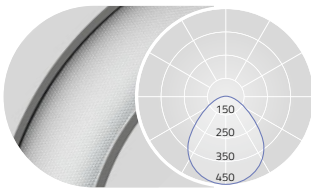

DIRECT: 100%

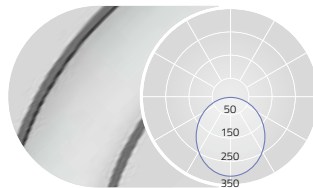

DIRECT: 100%

D mm	Lumen/Watt Low Power	Lumen/Watt Medium Power
600	2600lm/25W	3560lm/35W
900	4140lm/39W	5580lm/54W
1200	6250lm/56W	8430lm/78W
1500	7770lm/70W	10450lm/102W
2000	10360lm/91W	13940lm/124W
2500	14510lm/124W	19410lm/156W
3000	17860lm/138W	23890lm/188W
3500	20090lm/157W	26870lm/214W
4000	23440lm/193W	31350lm/250W
5000	29020lm/225W	38810lm/307W
6000	35710lm/275W	47770lm/375W
7000	42410lm/329W	56730lm/448W
8000	47430lm/372W	63450lm/500W

D mm	Lumen/Watt Low Power	Lumen/Watt Medium Power
600	2690lm/25W	3680lm/35W
900	4290lm/39W	5770lm/54W
1200	6470lm/56W	8720lm/78W
1500	8040lm/70W	10820lm/102W
2000	10710lm/91W	14420lm/124W
2500	12500lm/124W	16720lm/156W
3000	15390lm/138W	20580lm/188W
3500	17310lm/157W	23160lm/214W
4000	20200lm/193W	27020lm/250W
5000	25010lm/225W	33450lm/307W
6000	30780lm/275W	41170lm/375W
7000	36550lm/329W	48890lm/448W
8000	40880lm/372W	54670lm/500W

Lumen Values: Luminaire luminous flux at 4000K/CRI>80 / surface finished Snow White. Other configurations on request.



# LIQUID LINE RECESSED



RUSSELL MCVEAGH, AUCKLAND HARBOUR, NEW ZEALAND  
LIQUID LINE-F3





LIQUID LINE  
RECESSED





CABRINI HOSPITAL, MALVERN, AUSTRALIA  
LIQUID LINE-F3  
PHOTOS: PETER CLARKE

# LIQUID LINE RECESSED



THE BAYS HOSPITAL, MORNINGTON, AUSTRALIA  
LIQUID LINE-F3  
PHOTOS: PAOLO CAPPELLI





LIQUID LINE  
RECESSED





WESTFIELD MALL, LONDON, UK  
LIQUID LINE-F3

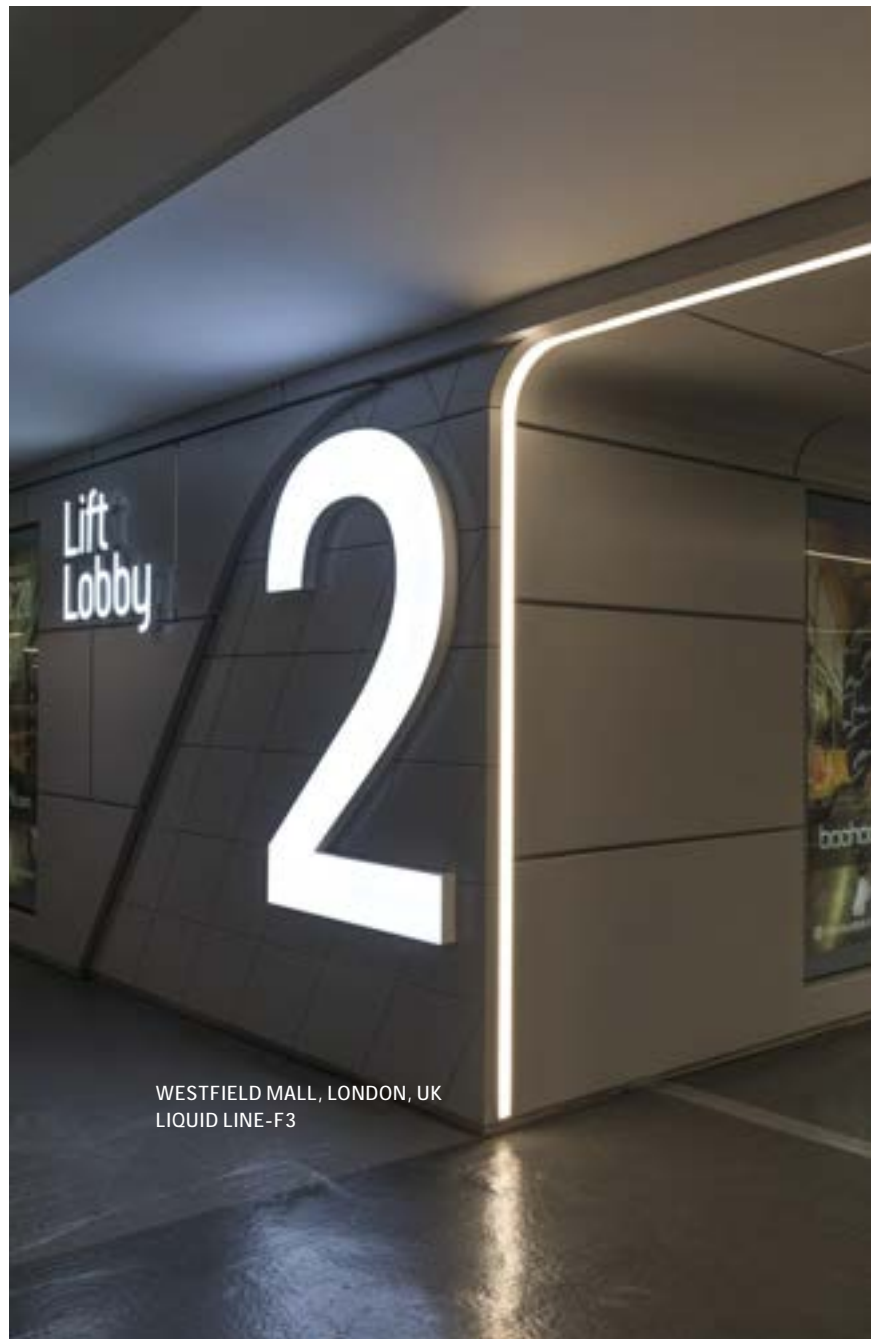

WESTFIELD MALL, LONDON, UK  
LIQUID LINE-F3

LIQUID LINE  
RECESSED | F3



**DE** LED-Einbauleuchte mit umlaufendem Rahmen für Montage in gesägten Deckenöffnungen. Rein direktstrahlend. Leuchtenkörper aus Aluminiumprofil mit 60mm Lichtspurbreite. Oberfläche weiß, silber, graphit, schwarz, champagner oder kupferfarben lackiert. Weitere Oberflächenoptionen siehe Lightnet-Surface-Collection oder RAL nach Wahl. Microprismenoptik mit optimierter Blendungsbegrenzung speziell für Office-Anwendungen. Satinierter Opaldiffusor für Allgemeinbeleuchtung. Konverter in Leuchtgehäuse integriert, wahlweise einfach schaltbar oder stufenlos dimmbar (1-10V, DALI, Touch-Dim, Casambi). Farbtemperaturen 2200K, 2700K, 3000K, 3500K, 4000K oder 6500K. Binning initial  $\leq$  MacAdam 3. Farbwiedergabe CRI>80 oder CRI>90. Beliebige Kombination aller 90°-Module, X- und Y-Verbinder, linearer und gebogener Elemente der Familie Liquid Line 3D übergreifend möglich. Hochflexibles System geeignet für millimetergenauen Zuschnitt auf Maß sowie Individuallösungen

**EN** Recessed mounted LED luminaire with surrounding frame for installation in ceilings with cut-out openings. Direct only light distribution. Luminaire body made of aluminium profile with 60mm width. Surface white, silver, graphite, black, champagne or copper coated. Further surface options see Lightnet-Surface-Collection or RAL of your choice. Microprismatic screen with optimized glare reduction especially for workplaces. Satin opal diffuser for general lighting. Driver integrated into luminaire housing, optionally switchable or dimmable (1-10V, DALI, Touch-Dim, Casambi). Colour temperatures 2200K, 2700K, 3000K, 3500K, 4000K or 6500K. Binning initial  $\leq$  MacAdam 3. Colour rendering CRI>80 or CRI>90. Arbitrary combination of all 90° modules, X- and Y-connectors, linear and curved elements of the Liquid Line 3D family is possible. Highly flexible system suited for millimetre accurate customizing as well as individual solutions.

**FR** Luminaire encastré LED avec cadre-colerette pour montage dans plafonds à découpes. Éclairage seulement direct. Corps du luminaire en profilé aluminium avec 60mm de largeur du spectre lumineux. Surface laquée blanc, argent, graphite, noir, champagne ou cuivre. Autres options de finition voir Lightnet-Surface-Collection ou RAL au choix. Diffuseur microprismatique optimisé pour un éblouissement limité et adapté aux bureaux. Diffuseur opale satinée pour un éclairage général. Driver intégré dans le luminaire, au choix ON/OFF ou graduable (1-10V, DALI, Touch-Dim, Casambi). Température de couleur 2200K, 2700K, 3000K, 3500K, 4000K ou 6500K. Binning initial  $\leq$  MacAdam 3. Rendu de couleur CRI>80 ou CRI>90. Combinaison possible et mélangée au choix de tous les modules angle à 90°, en forme de X- et Y-, éléments droits et ceintrés de la famille Liquid Line 3D. Système d'éclairage hautement flexible adapté pour des solutins individuelles multiples au millimètre près.

## LINEAR MODULES

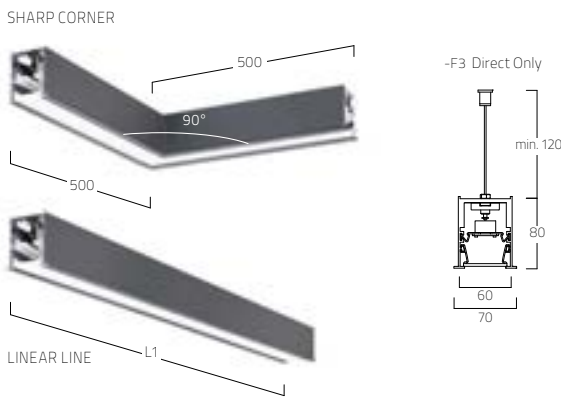

<b>PRODUCT-CODE:</b>	<b>Q F3 A S E - 8 30 M - L 1178</b>
PRODUCT FAMILY	- Q: Liquid Line
TYPE	- F3: Direct Only
OPTICAL SYSTEM	- A: Microprismatic, O: Opal
SURFACE FINISH	- W: Snow White, V: Ivory White, S: Radiant Silver, U: Urban Graphite, B: Jet Black, H: Champagne Silver, K: Satin Copper
CONTROL GEAR	- E: On/Off, L: DALI, D: 1-10V, H: Touch-Dim, C: Casambi
COLOUR REND.	- 8: CRI>80, 9: CRI>90, F: Full Spectrum
COLOUR TEMP.	- 22: 2200K, 27: 2700K, 30: 3000K, 35: 3500K, 40: 4000K, 65: 6500K
POWER	- E: Low Power, M: Medium Power, H: High Power
FORM	- L: Line, K: Corner
SIZE	- Line Length in mm: 600, 888, 1178, 1472, 2340, Corner: 500x500
ON REQUEST	- Emergency Module, Tunable White



## CURVE MODULES

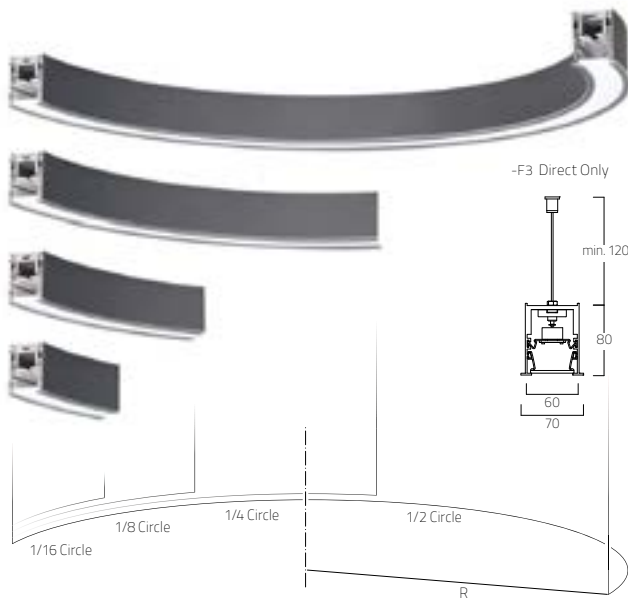

<b>PRODUCT-CODE:</b>	<b>Q F3 O S E - 8 30 M - CH - R050 - L1570</b>
PRODUCT FAMILY	- Q: Liquid Line
TYPE	- F3: Direct-Indirect
OPTICAL SYSTEM	- A: Microprismatic, O: Opal
SURFACE FINISH	- W: Snow White, V: Ivory White, S: Radiant Silver, U: Urban Graphite, B: Jet Black, H: Champagne Silver, K: Satin Copper
CONTROL GEAR	- E: On/Off, L: DALI, D: 1-10V, H: Touch-Dim, C: Casambi
COLOUR REND.	- 8: CRI>80, 9: CRI>90, F: Full Spectrum
COLOUR TEMP.	- 22: 2200K, 27: 2700K, 30: 3000K, 35: 3500K, 40: 4000K, 65: 6500K
POWER	- E: Low Power, M: Medium Power, H: High Power
FORM	- C: Curve Module
ARC SECTION	- H: 1/2 curve, Q: 1/4 curve, E: 1/8 curve, S: 1/16 curve
RADIUS	- R050: R500mm, R075: R750mm, R100: R1000mm, R125: R1250mm, R150: R1500mm, R175: R1750mm, R200: R2000mm, R250: R2500mm, R300: R3000mm, R350: R3500mm, R400: R4000mm
LENGTH	- Length in mm
ON REQUEST	- Emergency Module, Tunable White



MICROPRISMATIC / DIRECT

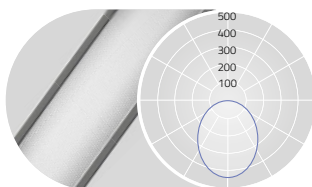

DIRECT: 100%

Lumen/Watt Low Power	1420lm/17W per m
Lumen/Watt Medium Power	2070lm/23W per m
Lumen/Watt High Power	2690lm/32W per m

OPAL DIFFUSER / DIRECT

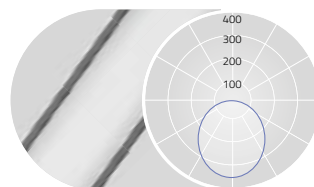

DIRECT: 100%

Lumen/Watt Low Power	1190lm/17W per m
Lumen/Watt Medium Power	1730lm/23W per m
Lumen/Watt High Power	2250lm/32W per m

CALEO LINEAR  
RECESSED | L3



**DE** LED-Einbauleuchte für rahmenlose Montage in Gipskartondecken. Rein direktstrahlend. Lichtkanal aus Aluminiumprofil mit 55mm Lichtspur-Breite. Oberfläche silber. Microprismenoptik mit optimierter Blendungsbegrenzung speziell für Office-Anwendungen. Satinierter Opaldiffusor für Allgemeinbeleuchtung. Konverter in Leuchtgehäuse integriert, wahlweise einfach schaltbar oder stufenlos dimmbar (1-10V, DALI, Touch-Dim, Casambi). Farbtemperaturen 2200K, 2700K, 3000K, 3500K, 4000K oder 6500K. Binning initial ≤ MacAdam 3. Farbwiedergabe CRI>80 oder CRI>90. Befestigungsset inklusive. Leuchtenprofil für Montage vorab lieferbar; restliche Leuchtenkomponenten zeitlich versetzt montierbar.

**EN** Recessed mounted LED luminaire for frameless installation in plasterboard ceilings. Direct only light distribution. Light channel made of aluminium profile with 55mm track width. Surface silver. Microprismatic with optimized glare reduction especially for workplaces. Satin opal diffuser for general lighting. Converter integrated into luminaire housing, optionally switchable or dimmable (1-10V, DALI, Touch-Dim, Casambi). Colour temperatures 2200K, 2700K, 3000K, 3500K, 4000K or 6500K. Binning initial ≤ MacAdam 3. Colour rendering CRI>80 or CRI>90. Mounting brackets included. Luminaire profile available in advance for mounting; other luminaire components can be mounted at different times.

**FR** Luminaire LED encastré sans cadre pour plafonds en placoplâtre. Éclairage seulement direct. Rail lumineux en profilé d'aluminium avec une largeur d'éclairage de 55mm. Surface argent. Diffuseur microprismatique optimisé pour un éblouissement limité et adapté aux bureaux. Diffuseur opale satinée pour un éclairage général. Driver intégré dans le luminaire, au choix ON/OFF ou graduable (1-10V, DALI, Touch-Dim, Casambi). Température de couleur 2200K, 2700K, 3000K, 3500K, 4000K ou 6500K. Binning initial ≤ MacAdam 3. Rendu de couleur CRI>80 ou CRI>90. Cadre de montage et kit de fixations inclus. Cadre de montage en encastré ou profilé vide livrable et disponible en avance; montage possible des composants restants du luminaire, ultérieurement.

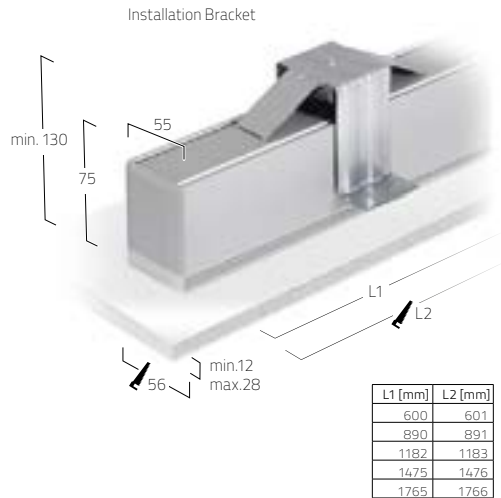

**PRODUCT-CODE:** A L3 O E E - 8 30 M - L600

- PRODUCT FAMILY - **A** Caleo
- TYPE - **L3** Direct Only
- OPTICAL SYSTEM - **O** Opal, **A** Microprismatic
- SURFACE FINISH - **E** Silver Anodised
- CONTROL GEAR - **E**: On/Off, **L**: DALI, **D**: 1-10V, **H**: Touch-Dim, **C**: Casambi
- COLOUR REND. - **8**: CRI>80, **9**: CRI>90, **F**: Full Spectrum
- COLOUR TEMP. - **22**: 2200K, **27**: 2700K, **30**: 3000K, **35**: 3500K, **40**: 4000K, **65**: 6500K, **TW**: Tunable White 2700-6500K [L894-L1765]
- POWER - **M**: Medium Power, **H**: High Power
- SIZE - Luminaire length in mm: **L600, L894, L1182, L1475, L1765**
- ON REQUEST - Emergency Module

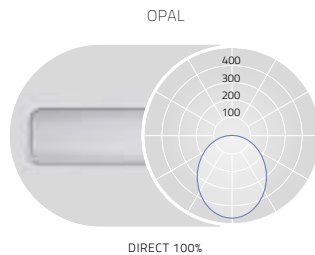
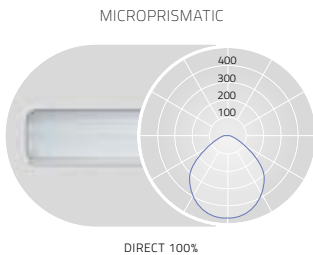

L mm	Lumen/Watt Medium Power	Lumen/Watt High Power
600	1060lm/16W	1530lm/24W
894	1580lm/22W	2290lm/34W
1182	2110lm/28W	3050lm/43W
1475	2640lm/34W	3820lm/52W
1765	3170lm/40W	4580lm/62W

L mm	Lumen/Watt Medium Power	Lumen/Watt High Power
600	1490lm/16W	2160lm/24W
894	2240lm/22W	3230lm/34W
1182	2980lm/28W	4310lm/43W
1475	3730lm/34W	5390lm/52W
1765	4470lm/40W	6470lm/62W

Lumen Values: Luminaire luminous flux at 4000K/CRI>80. Other configurations on request.

CALEO  
RECESSED | M2



**DE** LED-Einbauleuchte für rahmenlose Montage in Gipskartondecken. Rein direktstrahlend. Leuchtenkörper aus Aluminium. Oberfläche weiß. Microprismenoptik mit optimierter Blendungsbegrenzung speziell für Office-Anwendungen. Satinierter Opaldiffusor für Allgemeinbeleuchtung. Konverter in Leuchtgehäuse integriert, wahlweise einfach schaltbar oder stufenlos dimmbar (1-10V, DALI, Touch-Dim, Casambi). Farbtemperaturen 2200K, 2700K, 3000K, 3500K, 4000K oder 6500K. Binning initial  $\leq$  MacAdam 3. Farbwiedergabe CRI>80 oder CRI>90. Befestigungsset inklusive.

**EN** Recessed mounted LED luminaire for frameless installation in plasterboard ceilings. Direct only light distribution. Luminaire body made of aluminium. Surface white. Microprismatic with optimized glare reduction especially for workplaces. Satin opal diffuser for general lighting. Converter integrated into luminaire housing, optionally switchable or dimmable (1-10V, DALI, Touch-Dim, Casambi). Colour temperatures 2200K, 2700K, 3000K, 3500K, 4000K or 6500K. Binning initial  $\leq$  MacAdam 3. Colour rendering CRI>80 or CRI>90. Mounting brackets included.

**FR** Luminaire LED encastré sans cadre pour plafonds en placoplâtre. Éclairage seulement direct. Corps du luminaire en aluminium. Surface blanc. Diffuseur microprismatique optimisé pour un éblouissement limité et adapté aux bureaux. Diffuseur opale satinée pour un éclairage général. Driver intégré dans le luminaire, au choix ON/OFF ou graduable (1-10V, DALI, Touch-Dim, Casambi). Température de couleur 2200K, 2700K, 3000K, 3500K, 4000K ou 6500K. Binning initial  $\leq$  MacAdam 3. Rendu de couleur CRI>80 ou CRI>90. Cadre de montage et kit de fixations inclus.

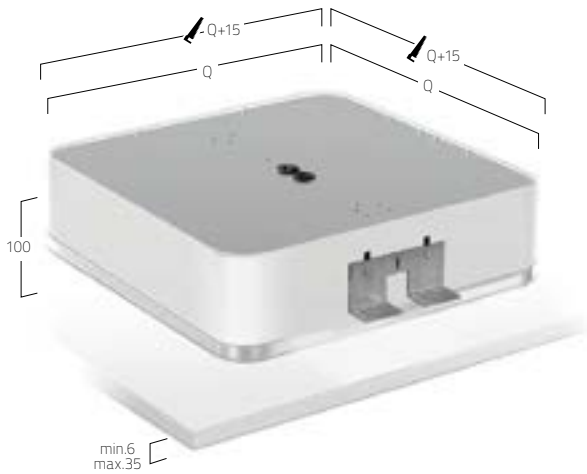

**PRODUCT-CODE:** A M2 O W E - 8 30 M - Q340

PRODUCT FAMILY	- A: Caleo
TYPE	- M2: Direct Only
OPTICAL SYSTEM	- O: Opal, A: Microprismatic
SURFACE FINISH	- W: Snow White
CONTROL GEAR	- E: On/Off, L: DALI, D: 1-10V, H: Touch-Dim, C: Casambi
COLOUR REND.	- 8: CRI>80, 9: CRI>90, F: Full Spectrum
COLOUR TEMP.	- 22: 2200K, 27: 2700K, 30: 3000K, 35: 3500K, 40: 4000K, 65: 6500K, TW: Tunable White 2700-6500K
POWER	- M: Medium Power, H: High Power
SIZE	- Square Size in mm: Q340, Q420, Q612
ON REQUEST	- Emergency Module, Radar Sensor



MICROPRISMATIC / DIRECT

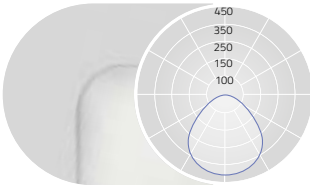

UGR $\leq$ 19 for Medium Power (X=4H, Y=8H, S=0.25H)  
DIRECT: 100%

OPAL DIFFUSER / DIRECT

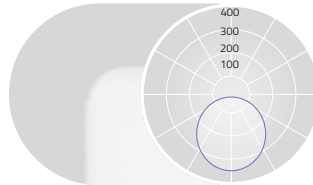

DIRECT: 100%

Q mm	Lumen/Watt Medium Power	Lumen/Watt High Power
340	1360lm/12W	2010lm/18W
420	2370lm/20W	3450lm/29W
612	5200lm/40W	8500lm/65W

Q mm	Lumen/Watt Medium Power	Lumen/Watt High Power
340	1400lm/12W	2070lm/18W
420	2440lm/20W	3550lm/29W
612	5360lm/40W	8760lm/65W

Lumen Values: Luminaire luminous flux at 4000K/CRI>80 / surface finished Snow White. Other configurations on request.



CUBIC MAX  
RECESSED AURA | N2



**DE** LED-Einbauleuchte für rahmenlose Montage in Gipskartondecken. Direktstrahlend mit indirekter Lichtkorona. Oberfläche natureloxiert oder weiß, graphit, schwarz bzw. champagnerfarben lackiert. Weitere Oberflächenoptionen siehe Lightnet-Surface-Collection oder RAL nach Wahl. Microprismenoptik mit optimierter Blendungsbegrenzung speziell für Office-Anwendungen. Satinierter Opaldiffusor für Allgemeinbeleuchtung mit max. Transmissionsgrad und homogener Lichtpunktauflösung. Konverter in Leuchtgehäuse integriert, wahlweise einfach schaltbar oder stufenlos dimmbar (1-10V, DALI, Touch-Dim, Casambi). Farbtemperaturen 2700K, 3000K, 3500K, 4000K. Binning initial ≤ Mac Adam 3. Farbwiedergabe CRI>80 oder CRI>90. Befestigungsset zur Montage inklusive. Farbliche Auswahl der indirekten Lichtaura in rot, grün, blau und magenta. Auf Anfrage: Integration von Notlichtkomponenten, Sensortechnologie.

**EN** Recessed mounted LED luminaire for frameless installation in plasterboard ceilings. Direct light distribution and indirect lighting corona. Surface natural anodised or white, graphite, black or champagne coated. Further surface options see Lightnet-Surface-Collection or RAL of your choice. Microprismatic with optimized glare reduction especially for workplaces. Satin opal diffuser for general lighting with maximum transmittance and homogeneous lighting. Converter integrated into luminaire housing, optionally switchable or dimmable (1-10V, DALI, Touch-Dim, Casambi). Colour temperature 2700K, 3000K, 3500K or 4000K. Binning initial ≤ MacAdam 3. Colour rendering CRI>80 or CRI>90. Mounting brackets included. Colour selection of the indirect light aura: red, green, blue and magenta. On request: Integration of emergency lighting components, sensor technology.

**FR** Luminaire LED encastré sans cadre pour plafonds en placoplâtre. Éclairage direct avec colerette de lumière indirecte. Surface anodisée ou laquée blanc, graphite, noir ou champagne. Autres options de finition voir Lightnet-Surface-Collection ou RAL au choix. Diffuseur microprismatique optimisé pour un éblouissement limité et adapté aux bureaux. Diffuseur opale satiné pour un éclairage général et une transmission maximale et homogène. Driver intégré dans le luminaire, au choix ON/OFF ou graduable (1-10V, DALI, Touch-Dim, Casambi). Température de couleur 2700K, 3000K, 3500K ou 4000K. Binning initial ≤ MacAdam 3. Rendu de couleur CRI>80 ou CRI>90. Support de fixation inclus. Couleur au choix de l'éclairage indirect aura: rouge, vert, bleu et magenta. Sur demande: Intégration de composants d'éclairage de secours ou de capteurs.

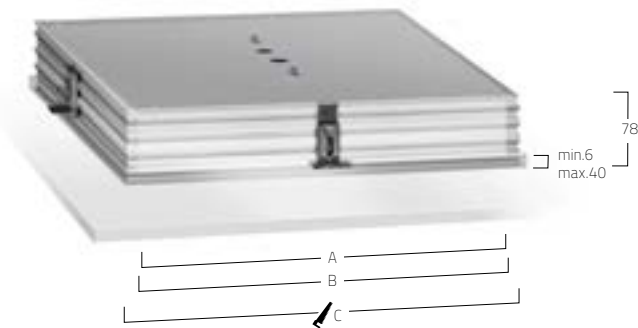

A (frame)	B (recessed housing)	C (cut out)
330	380	398
430	480	498
530	580	598
630	680	698

**PRODUCT-CODE:** C N2 A B E - 8 30 M - Q330 - R

PRODUCT FAMILY	- C: Cubic
TYPE	- N2: Direct with Indirect Corona
OPTICAL SYSTEM	- A: Microprismatic, O: Opal
SURFACE FINISH	- W: Snow White, E: Silver Anodised, U: Urban Graphite, B: Jet Black, H: Champagne Silver *
CONTROL GEAR	- E: On/Off, L: DALI, D: 1-10V, H: Touch-Dim, C: Casambi
COLOUR REND.	- 8: CRI>80, 9: CRI>90, F: Full Spectrum
COLOUR TEMP.	- 27: 2700K, 30: 3000K, 35: 3500K, 40: 4000K, TW: Tunable White 2700-6500K [Q430-Q630]
POWER	- M: Medium Power, H: High Power
SIZE	- Square Size in mm: Q330, Q430, Q530, Q630
AURA COLOUR	- R: Red, G: Green, B: Blue, M: Magenta, W: White
ON REQUEST	- Emergency Module

\* Housing for frameless installation is always white.



MICROPRISMATIC / DIRECT



UGR≤19 for Medium Power (X=4H, Y=8H, S=0.25H)  
DIRECT: 100%

OPAL DIFFUSER / DIRECT

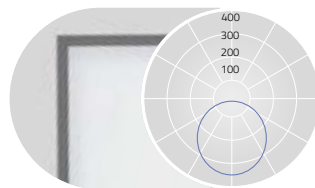

DIRECT: 100%

Q mm	Lumen/Watt Medium Power	Lumen/Watt High Power
330	1470lm/19W	2170lm/28W
430	2570lm/31W	3740lm/45W
530	3870lm/40W	7230lm/80W
630	5500lm/68W	8940lm/103W

Q mm	Lumen/Watt Medium Power	Lumen/Watt High Power
330	1500lm/19W	2220lm/28W
430	2640lm/31W	3820lm/45W
530	3900lm/40W	7300lm/80W
630	5660lm/68W	9210lm/103W

Lumen Values: Luminaire luminous flux at 4000K/CRI>80. Other configurations on request.



CUBIC MAX  
RECESSED FRAMELESS | M2



**DE** LED-Einbauleuchte für rahmenlose Montage in Gipskartondecken. Rein direktstrahlend. Leuchtenkörper aus Aluminium. Oberfläche weiß pulverlackiert. Microprismenoptik mit optimierter Blendungsbegrenzung speziell für Office-Anwendungen. Satinierter Opaldiffusor für Allgemeinbeleuchtung mit max. Transmissionsgrad und homogener Lichtpunktauflösung. Konverter in Leuchtgehäuse integriert, wahlweise einfach schaltbar oder stufenlos dimmbar (1-10V, DALI, Touch-Dim, Casambi). Farbtemperaturen 2700K, 3000K, 3500K oder 4000K. Binning initial ≤ MacAdam 3. Farbwiedergabe CRI>80 oder CRI>90. Befestigungsset zur Montage inklusive. Auf Anfrage: Integration von Notlichtkomponenten.

**EN** Recessed mounted LED luminaire for frameless installation in plasterboard ceilings. Direct only light distribution. Luminaire body made of aluminium. Surface white powder-coated. Microprismatic screen with optimized glare reduction especially for workplaces. Satin opal diffuser for general lighting with maximum transmittance and homogeneous lighting. Converter integrated into luminaire housing, optionally switchable or dimmable (1-10V, DALI, Touch-Dim, Casambi). Colour temperature 2700K, 3000K, 3500K or 4000K. Binning initial ≤ MacAdam 3. Colour rendering CRI>80 or CRI>90. Mounting brackets included. On request: Integration of emergency lighting components.

**FR** Luminaire LED encastré sans cadre pour plafonds en placoplâtre. Éclairage seulement direct. Corps du luminaire en aluminium. Revêtement blanc par poudrage. Diffuseur microprismatique optimisé pour un éblouissement limité et adapté aux bureaux. Diffuseur opale satiné pour un éclairage général et une transmission maximale et homogène. Driver intégré dans le luminaire, au choix ON/OFF ou graduable (1-10V, DALI, Touch-Dim, Casambi). Température de couleur 2700K, 3000K, 3500K ou 4000K. Binning initial ≤ MacAdam 3. Rendu de couleur CRI>80 ou CRI>90. Support de fixation inclus. Sur demande: Intégration de composants d'éclairage de secours.

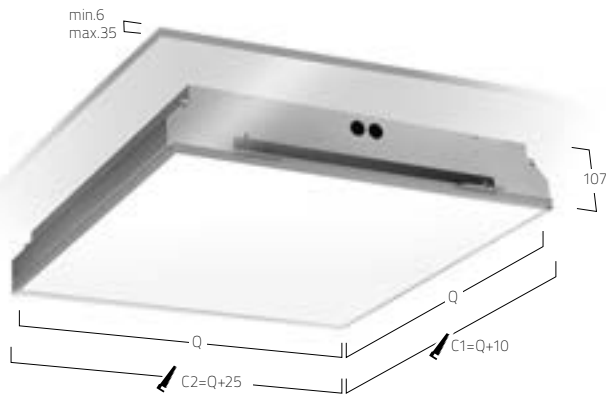

**PRODUCT-CODE:** C M2 O W E - 8 30 M - Q340

- PRODUCT FAMILY – C: Cubic
- TYPE – M2: Recessed Frameless Direct Only
- OPTICAL SYSTEM – A: Microprismatic, O: Opal
- SURFACE FINISH – W: Snow White
- CONTROL GEAR – E: On/Off, L: DALI, D: 1-10V, H: Touch-Dim, C: Casambi
- COLOUR REND. – 8: CRI>80, 9: CRI>90, F: Full Spectrum
- COLOUR TEMP. – 27: 2700K, 30: 3000K, 35: 3500K, 40: 4000K, TW: Tunable White 2700-6500K
- POWER – M: Medium Power, H: High Power
- SIZE – Square Size in mm: Q340, Q420, Q612
- ON REQUEST – Emergency Module



MICROPRISMATIC / DIRECT

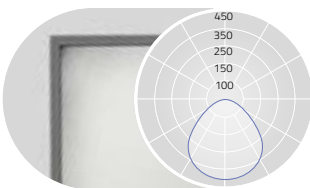

UGR<19 for Medium Power (X=4H, Y=8H, S=0.25H)  
DIRECT: 100%

OPAL DIFFUSER / DIRECT

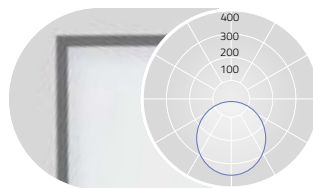

DIRECT: 100%

Q mm	Lumen/Watt Medium Power	Lumen/Watt High Power
340	1330lm/12W	1970lm/18W
420	2250lm/20W	3280lm/29W
612	4420lm/40W	7230lm/65W

Q mm	Lumen/Watt Medium Power	Lumen/Watt High Power
340	1360lm/12W	2010lm/18W
420	2320lm/20W	3370lm/29W
612	5090lm/40W	8320lm/65W

Lumen Values: Luminaire luminous flux at 4000K/CRI>80. Other configurations on request.

CUBIC MAX  
RECESSED FRAME | M4



**DE** LED-Einbauleuchte mit umlaufendem Rahmen für gesägte Deckenöffnungen. Rein direktstrahlend. Leuchtenkörper aus Aluminium. 7 verschiedene Durchmesser von 220 bis 1250mm. Oberfläche weiß, silber, graphit, schwarz, champagner oder kupferfarben lackiert. Weitere Oberflächenoptionen siehe Lightnet-Surface-Collection oder RAL nach Wahl. Microprismenoptik mit optimierter Blendungsbegrenzung speziell für Office-Anwendungen. Satinierter Opaldiffusor für Allgemeinbeleuchtung mit max. Transmissionsgrad und homogener Lichtpunktauflösung. Konverter in Leuchtgehäuse integriert, wahlweise einfach schaltbar oder stufenlos dimmbar (1-10V, DALI, Touch-Dim). Farbtemperaturen 2200K, 2700K, 3000K, 3500K, 4000K oder 6500K. Binning initial  $\leq$  MacAdam 3. Farbwiedergabe CRI>80 oder CRI>90. Befestigungsset zur Montage inklusive. Nicht geeignet für Wandinstallation. Auf Anfrage: Integration von Notlichtkomponenten, Sensortechnologie, Casambi.

**EN** Recessed mounted LED luminaire with surrounding frame for ceilings with cut-out openings. Direct only light distribution. Luminaire body made of aluminium. 7 different diameters from 220mm to 1250mm. Surface white, silver, graphite, black, champagne or copper coated. Further surface options see Lightnet-Surface-Collection or RAL of your choice. Microprismatic screen with optimized glare reduction especially for workplaces. Satin opal diffuser for general lighting with maximum transmittance and homogeneous lighting. Driver integrated into luminaire housing, optionally switchable or dimmable (1-10V, DALI, Touch-Dim). Colour temperatures 2200K, 2700K, 3000K, 3500K, 4000K or 6500K. Binning initial  $\leq$  MacAdam 3. Colour rendering CRI>80 or CRI>90. Mounting brackets included. Installation in walls not possible. On request: Integration of emergency lighting components, sensor technology, Casambi.

**FR** Luminaire encastré LED avec cadre périphérique pour un montage sur plafond à ouvertures sciées. Éclairage seulement direct. Corps du luminaire en aluminium. 7 diamètres différents de 220mm à 1250mm. Surface laquée blanc, argent, graphite, noir, champagne ou cuivre. Autres options de finition voir Lightnet-Surface-Collection ou RAL au choix. Diffuseur microprismatique optimisé pour un éblouissement limité et adapté aux bureaux. Diffuseur opale satiné pour un éclairage général et une transmission maximale et homogène. Driver intégré dans le luminaire, au choix ON /OFF ou graduable (1-10V, DALI, Touch-Dim). Température de couleur 2200K, 2700K, 3000K, 3500K, 4000K ou 6500K. Binning initial  $\leq$  Mac Adam 3. Rendu de couleur CRI>80 ou CRI>90. Support de fixation inclus. Pas adapté pour une installation murale. Sur demande: Intégration de composants d'éclairage de secours ou de capteurs, Casambi.

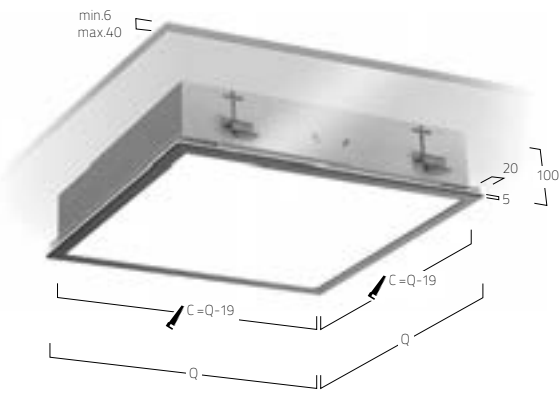

**PRODUCT-CODE:** C M4 A B E - 8 30 M - Q379

PRODUCT FAMILY	- C. Cubic
TYPE	- M4: Recessed Frame Direct Only
OPTICAL SYSTEM	- A: Microprismatic, O: Opal
SURFACE FINISH	- W: Snow White, E: Silver Anodised, U: Urban Graphite, B: Jet Black, H: Champagne Silver
CONTROL GEAR	- E: On/Off, L: DALI, D: 1-10V, H: Touch-Dim, C: Casambi
COLOUR REND.	- 8: CRI>80, 9: CRI>90, F: Full Spectrum
COLOUR TEMP.	- 27: 2700K, 30: 3000K, 35: 3500K, 40: 4000K, TW: Tunable White 2700-6500K
POWER	- M: Medium Power, H: High Power
SIZE	- Square Size in mm: Q379, Q479, Q621, Q910
ON REQUEST	- Emergency Module



MICROPRISMATIC / DIRECT

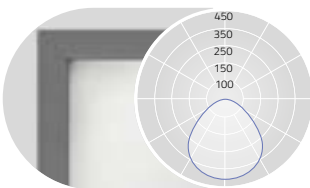

UGR $\leq$ 19 for Medium Power (X=4H, Y=8H, S=0.25H)  
DIRECT: 100%

OPAL DIFFUSER / DIRECT

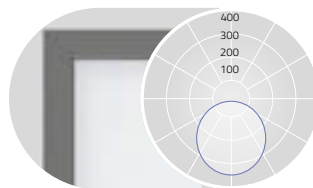

DIRECT: 100%

Q mm	Lumen/Watt Medium Power	Lumen/Watt High Power
379	1360lm/12W	2010lm/18W
479	2370lm/20W	3450lm/29W
621	5200lm/40W	8500lm/65W
910	7910lm/67W	13240lm/129W

Q mm	Lumen/Watt Medium Power	Lumen/Watt High Power
379	1400lm/12W	2070lm/18W
479	2440lm/20W	3550lm/29W
621	5360lm/40W	8760lm/65W
910	8150lm/67W	13640lm/129W

Lumen Values: Luminaire luminous flux at 4000K/CRI>80. Other configurations on request.

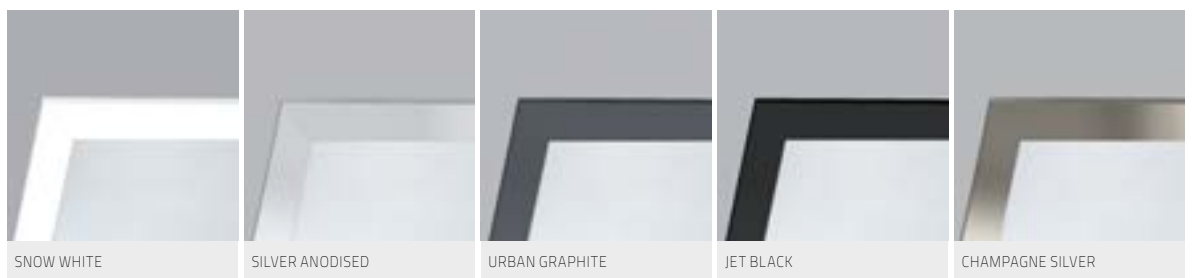

CUBIC AMBIENT  
SEMI-RECESSED | M7

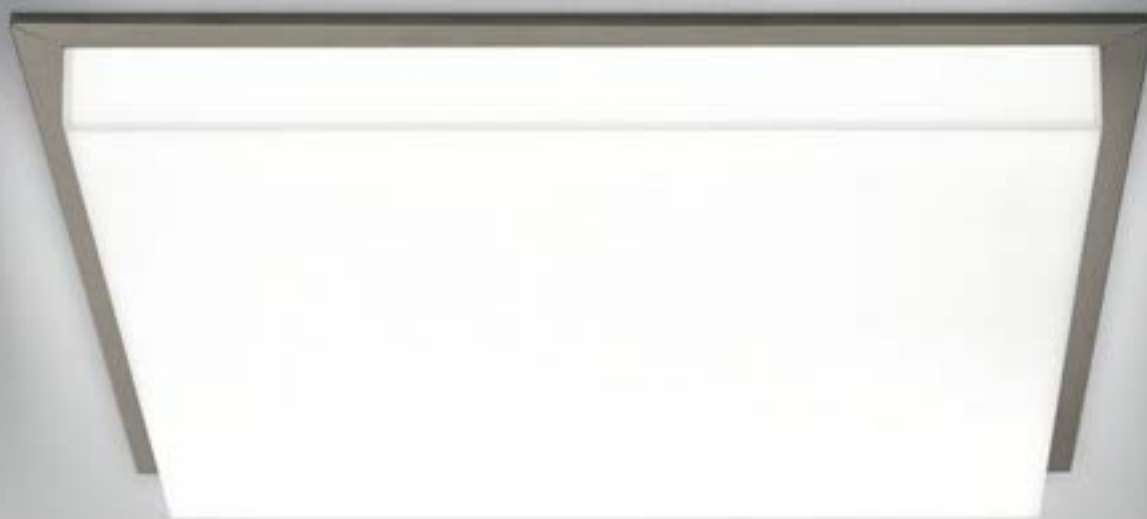

**DE** LED- Einbauleuchte mit umlaufendem Rahmen für gesägte Deckenöffnungen. Direkt-rundumstrahlend für dezente Deckenaufhellung. Leuchtenkörper aus Aluminium. Oberfläche natureloxiert oder weiß, graphit, schwarz bzw. champagnerfarben lackiert. Weitere Oberflächenoptionen siehe Lightnet-Surface-Collection oder RAL nach Wahl. Ambientdiffusor aus satiniertem Acrylglas für Allgemeinbeleuchtung. Konverter in Leuchtgehäuse integriert, wahlweise einfach schaltbar oder stufenlos dimmbar (1-10V, DALI, Touch-Dim, Casambi). Farbtemperaturen 2700K, 3000K, 3500K oder 4000K. Binning initial ≤ MacAdam 3. Farbwiedergabe CRI>80 oder CRI>90. Befestigungsset zur Montage inklusive. Auf Anfrage: Integration von Notlichtkomponenten, Sensortechnologie.

**EN** Recessed mounted LED luminaire with surrounding frame for ceilings with cut-out openings. Omnidirectional light distribution for discreet illumination of the ceiling. Luminaire body made of aluminium. Surface natural anodised or white, graphite, black or champagne coated. Further surface options see Lightnet-Surface-Collection or RAL of your choice. Ambient diffuser made of frosted acrylic glass for general lighting. Converter integrated into luminaire housing, optionally switchable or dimmable (1-10V, DALI, Touch-Dim, Casambi). Colour temperature 2700K, 3000K, 3500K or 4000K. Binning initial ≤ MacAdam 3. Colour rendering CRI>80 or CRI>90. Mounting brackets included. On request: Integration of emergency lighting components, sensor technology.

**FR** Luminaire encastré LED avec cadre périphérique pour un montage sur plafond à ouvertures sciées. Cadre de montage périphérique avec une hauteur totale visible de seulement 18 mm. Corps du luminaire en aluminium. Surface anodisée ou laquée blanc, graphite, noir ou champagne. Autres options de finition voir Lightnet-Surface-Collection ou RAL au choix. Diffuseur AMBIENT en verre satiné acrylique pour diverses applications d'éclairage. Driver intégré dans le luminaire, au choix ON/OFF ou graduable (1-10V, DALI, Touch-Dim, Casambi). Température de couleur 2700K, 3000K, 3500K ou 4000K. Binning initial ≤ MacAdam 3. Rendu de couleur CRI>80 ou CRI>90. Support de fixation inclus. Sur demande: Intégration de composants d'éclairage de secours ou de capteurs.

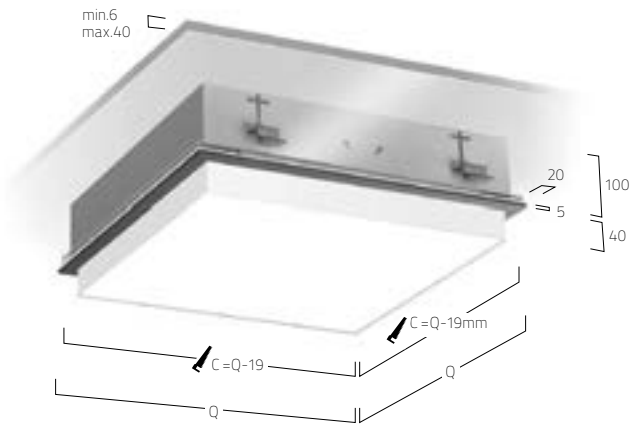

**PRODUCT-CODE:** C M7 F B E - 8 30 M - Q379

PRODUCT FAMILY	- C: Cubic
TYPE	- M7: Semi Recessed Direct Only
OPTICAL SYSTEM	- F: Ambient
SURFACE FINISH	- W: Snow White, E: Silver Anodised, U: Urban Graphite, B: Jet Black, H: Champagne Silver
CONTROL GEAR	- E: On/Off, L: DALI, D: 1-10V, H: Touch-Dim, C: Casambi
COLOUR REND.	- 8: CRI>80, 9: CRI>90, F: Full Spectrum
COLOUR TEMP.	- 27: 2700K, 30: 3000K, 35: 3500K, 40: 4000K, TW: Tunable White 2700-6500K
POWER	- M: Medium Power, H: High Power
SIZE	- Square Size in mm: Q379, Q479, Q621
ON REQUEST	- Emergency Module, Radar Sensor



AMBIENT DIFFUSER / DIRECT

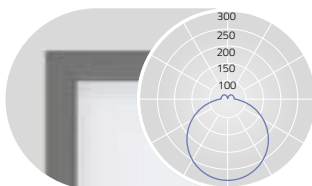

DIRECT: ca.98% INDIRECT: ca.2%

Q mm	Lumen/Watt Medium Power	Lumen/Watt High Power
379	1460lm/12W	2150lm/18W
479	2510lm/20W	3660lm/29W
621	5410lm/40W	8850lm/65W

Lumen Values: Luminaire luminous flux at 4000K/CRI>80. Other configurations on request.



SNOW WHITE

SILVER ANODISED

URBAN GRAPHITE

JET BLACK

CHAMPAGNE SILVER



CUBIC MAX  
RECESSED





TECHNISCHES RATHAUS HANNOVER, GERMANY  
CUBIC-M8  
PHOTOS: MARCUS BREDT

CUBIC MAX  
RECESSED





LHL JESSHEIM, OSLO, NORWAY  
CUBIC-M8

CUBIC MAX  
RECESSED MODULE | M8



**DE** LED-Einlegeleuchte für Decken mit sichtbaren Tragschienen (Modul 600/625). Rein direktstrahlend. Leuchtenkörper aus Aluminium und Stahlblech, weiß pulverlackiert. Microprismenoptik mit optimierter Blendungsbegrenzung speziell für Office-Anwendungen. Satiniertes Opaldiffusor für Allgemeinbeleuchtung mit max. Transmissionsgrad und homogener Lichtpunktauflösung. Konverter in Leuchtgehäuse integriert, wahlweise einfach schaltbar oder stufenlos dimmbar (1-10V, DALI, Touch-Dim, Casambi). Farbtemperaturen 2700K, 3000K, 3500K oder 4000K. Binning initial  $\leq$  MacAdam 3. Farbwiedergabe CRI>80 oder CRI>90. Auf Anfrage: Integration von Notlichtkomponenten, Sensortechnologie.

**EN** Recessed mounted LED luminaire for ceilings with exposed grids (Module 600/625). Direct only light distribution. Luminaire body made of aluminium and sheet steel, white powder-coated. Microprismatic screen with optimized glare reduction especially for workplaces. Satin opal diffuser for general lighting with maximum transmittance and homogeneous lighting. Converter integrated into luminaire housing, optionally switchable or dimmable (1-10V, DALI, Touch-Dim, Casambi). Colour temperature 2700K, 3000K, 3500K or 4000K. Binning initial  $\leq$  MacAdam 3. Colour rendering CRI>80 or CRI>90. On request: Integration of emergency lighting components, sensor technology.

**FR** Luminaire encastré LED pour plafonds avec grilles apparentes (Module 600/625). Éclairage seulement direct. Corps du luminaire en aluminium et acier, laqué blanc par poudrage. Diffuseur microprismatique optimisé pour un éblouissement limité et adapté aux bureaux. Diffuseur opale satiné pour un éclairage général et une transmission maximale et homogène. Driver intégré dans le luminaire, au choix ON/OFF ou graduable (1-10V, DALI, Touch-Dim, Casambi). Température de couleur 2700K, 3000K, 3500K ou 4000K. Binning initial  $\leq$  MacAdam 3. Rendu de couleur CRI>80 ou CRI>90. Sur demande: Intégration de composants d'éclairage de secours ou de capteurs.

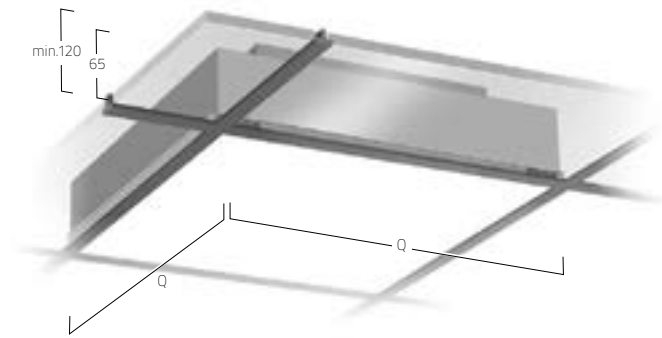

**PRODUCT-CODE:** C M8 O W E - 8 30 M - Q597

- PRODUCT FAMILY – C: Cubic
- TYPE – M8: Recessed Module Direct Only
- OPTICAL SYSTEM – A: Microprismatic, O: Opal
- SURFACE FINISH – W: Snow White
- CONTROL GEAR – E: On/Off, L: DALI, D: 1-10V, H: Touch-Dim, C: Casambi
- COLOUR REND. – 8: CRI>80, 9: CRI>90, F: Full Spectrum
- COLOUR TEMP. – 27: 2700K, 30: 3000K, 35: 3500K, 40: 4000K, TW: Tunable White 2700-6500K
- POWER – M: Medium Power, H: High Power
- SIZE – Square Size in mm: Q597 [for Module 600], Q621 [for Module 625]
- ON REQUEST – Emergency Module, Radar Sensor



MICROPRISMATIC / DIRECT

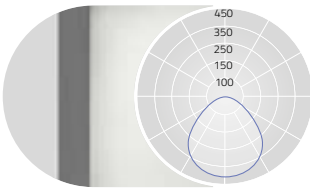

UGR $\leq$ 19 for Medium Power (X=4H, Y=8H, S=0.25H)  
DIRECT: 100%

OPAL DIFFUSER / DIRECT

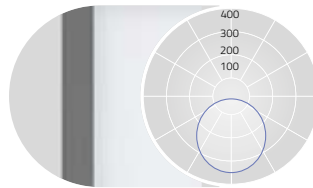

DIRECT: 100%

Q mm	Lumen/Watt Medium Power	Lumen/Watt High Power
597	5200lm/40W	8500lm/65W
621	5200lm/40W	8500lm/65W

Q mm	Lumen/Watt Medium Power	Lumen/Watt High Power
597	5360lm/40W	8760lm/65W
621	5360lm/40W	8760lm/65W

Lumen Values: Luminaire luminous flux at 4000K/CRI>80. Other configurations on request.

CUBIC MAX  
RECESSED MODULE | M9



**DE** LED-Einlegeleuchte für Decken mit sichtbaren Tragschienen (Modul 600/625). Rein direktstrahlend. Leuchtenkörper aus Aluminium und Stahlblech, weiß pulverlackiert. Microprismenoptik mit optimierter Blendungsbegrenzung speziell für Office-Anwendungen. Satiniertes Opaldiffusor für Allgemeinbeleuchtung mit max. Transmissionsgrad und homogener Lichtpunktauflösung. Konverter in Leuchtgehäuse integriert, wahlweise einfach schaltbar oder stufenlos dimmbar (1-10V, DALI, Touch-Dim, Casambi). Farbtemperaturen 2700K, 3000K, 3500K oder 4000K. Binning initial ≤ MacAdam 3. Farbwiedergabe CRI>80 oder CRI>90. Auf Anfrage: Integration von Notlichtkomponenten, Sensortechnologie.

**EN** Recessed mounted LED luminaire for ceilings with exposed grids (Module 600/625). Direct only light distribution. Luminaire body made of aluminium and sheet steel, white powder-coated. Microprismatic screen with optimized glare reduction especially for workplaces. Satin opal diffuser for general lighting with maximum transmittance and homogeneous lighting. Driver integrated into luminaire housing, optionally switchable or dimmable (1-10V, DALI, Touch-Dim, Casambi). Colour temperature 2700K, 3000K, 3500K or 4000K. Binning initial ≤ MacAdam 3. Colour rendering CRI>80 or CRI>90. On request: Integration of emergency lighting components, sensor technology.

**FR** Luminaire encastré LED pour plafonds avec grilles apparentes (Module 600/625). Éclairage seulement direct. Corps du luminaire en aluminium et acier, laqué blanc par poudrage. Diffuseur microprismatique optimisé pour un éblouissement limité et adapté aux bureaux. Diffuseur opale satiné pour un éclairage général et une transmission maximale et homogène. Driver intégré dans le luminaire, au choix ON/OFF ou graduable (1-10V, DALI, Touch-Dim, Casambi). Température de couleur 2700K, 3000K, 3500K ou 4000K. Binning initial ≤ MacAdam 3. Rendu de couleur CRI>80 ou CRI>90. Sur demande: Intégration de composants d'éclairage de secours ou de capteurs.

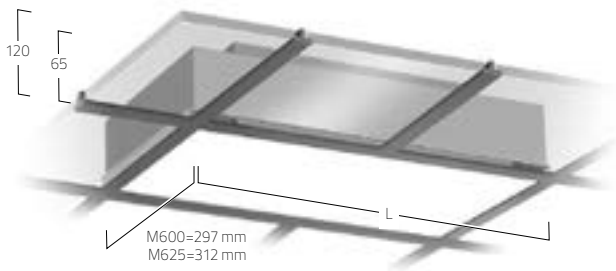

**PRODUCT-CODE: C M9 O W E - 8 30 M - L1197**

- PRODUCT FAMILY - **C**: Cubic
- TYPE - **M9**: Recessed Module Direct Only
- OPTICAL SYSTEM - **A**: Microprismatic, **O**: Opal
- SURFACE FINISH - **W**: Snow White
- CONTROL GEAR - **E**: On/Off, **L**: DALI, **D**: 1-10V, **H**: Touch-Dim, **C**: Casambi
- COLOUR REND. - **8**: CRI>80, **9**: CRI>90, **F**: Full Spectrum
- COLOUR TEMP. - **27**: 2700K, **30**: 3000K, **35**: 3500K, **40**: 4000K, **TW**: Tunable White 2700-6500K
- POWER - **M**: Medium Power, **H**: High Power
- SIZE - Luminaire Length in mm: **L1197** [for Module 600], **L1246** [for Module 625]
- ON REQUEST - Emergency Module, Radar Sensor



MICROPRISMATIC / DIRECT

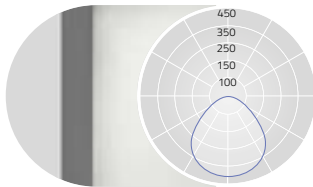

DIRECT: 100%

OPAL DIFFUSER / DIRECT

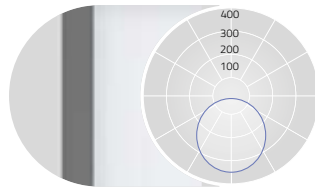

DIRECT: 100%

L mm	Lumen/Watt Medium Power	Lumen/Watt High Power
1197	5280lm/42W	7410lm/60W
1246	5280lm/42W	7410lm/60W

L mm	Lumen/Watt Medium Power	Lumen/Watt High Power
1197	5600lm/42W	7850lm/60W
1246	5600lm/42W	7850lm/60W

Lumen Values: Luminaire luminous flux at 4000K/CRI>80. Other configurations on request.



# MATRIC RECESSED



SUHRKAMP VERLAG, BERLIN, GERMANY  
MATRIC-F3



MATRIC 38 mm LENS LOUVER  
RECESSED FRAMELESS | M1



**DE** LED-Einbauleuchte für rahmenlose Montage in Gipskartondecken. Rein direktstrahlend. Lichtkanal aus Aluminiumprofil mit 38mm Lichtspur-Breite. Millimetergenaue Längenfertigung nach Vorgabe möglich. Oberfläche natureloxiert. Präzisionslinsen mit Abblendraster für breite rotations-symmetrische Lichtstärkeverteilung bei gleichzeitig hoher Blendungsbegrenzung (UGR<16). Raster in verschiedenen Farbausführung erhältlich. Konverter in Leuchtgehäuse integriert, wahlweise einfach schaltbar oder stufenlos dimmbar (1-10V, DALI, Touch-Dim, Casambi). Farbtemperaturen 2700K, 3000K oder 4000K. Binning initial ≤ MacAdam 3. Farbwiedergabe CRI>80. Einbaurahmen für Montage mit Schattenfuge vorab lieferbar; restliche Leuchtenkomponenten zeitlich versetzt montierbar. Einbaurahmen und Befestigungsset inklusive. Auf Anfrage: Integration von Notlichtkomponenten, Sensortechnologie sowie Vielzahl weiterer Optionen.

**EN** Recessed mounted LED luminaire for frameless installation in plasterboard ceilings. Direct only light distribution. Light channel made of aluminium profile with 38mm profile width. Precise length production according to specifications possible. Surface natural anodised. Precision lenses with louvre for wide rotationally symmetrical light distribution with high glare limitation (UGR<16). Louvre available in various colour combinations, optionally switchable or dimmable (1-10V, DALI, Touch-Dim, Casambi). Colour temperature 2700K, 3000K or 4000K. Binning initial ≤ MacAdam 3. Colour rendering CRI>80. Mounting frame for installation with shadow gap available in advance; other luminaire components can be mounted later. Mounting frame and mounting brackets included. On request: Integration of emergency lighting components, sensor technology as well as many other options.

**FR** Luminaire LED encastré sans cadre pour plafonds en placoplâtre. Éclairage seulement direct. Rail lumineux en profilé d'aluminium avec une largeur d'éclairage de 38mm. Fabrication au millimètre près des longueurs selon les spécifications. Surface anodisée. Lentilles de précision avec grille antiéblouissement pour une large répartition symétrique de l'intensité lumineuse et facteur d'antiéblouissement très bas (UGR<16). Grille antiéblouissement disponible en plusieurs combinaisons de couleurs. Driver intégré dans le luminaire, au choix ON/OFF ou graduable (1-10V, DALI, Touch-Dim, Casambi). Température de couleur 2700K, 3000K ou 4000K. Binning initial ≤ MacAdam 3. Rendu de couleur CRI>80. Cadre de montage en encastré livrable et disponible en avance; montage possible des éléments du luminaire restants, ultérieurement. Cadre de montage et kit de fixations inclus. Sur demande: Intégration de composants d'éclairage de secours ou de capteurs ainsi qu'une multitude d'autres options.

Installation Housing with Shadow Gap

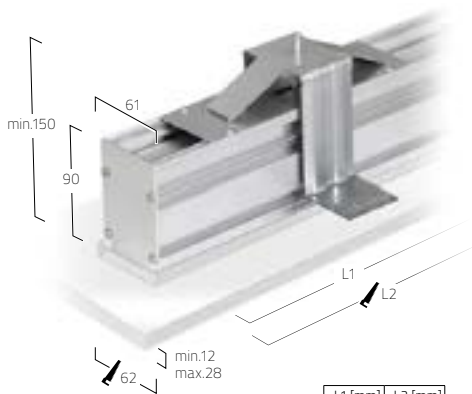

L1 [mm]	L2 [mm]
669	684
953	968
1237	1252
1521	1536
1805	1820

LENS LOUVER DIRECT ONLY

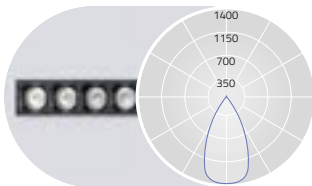

UGR<16 (X=4H, Y=8H, S=0.25H)  
DIRECT: 100%

L mm	Lumen/Watt Low Power	Lumen/Watt Medium Power
669	1260lm/15W	2030lm/24W
953	1800lm/20W	2900lm/33W
1237	2340lm/25W	3770lm/42W
1521	2880lm/31W	4640lm/52W
1805	3420lm/36W	5510lm/61W

Lumen Values: Luminaire luminous flux at 4000K/CRI>80. Other configurations on request.

**PRODUCT-CODE:**

**L M1 L E E - 8 30 M - L953 - F B**

PRODUCT FAMILY	- L: Matrix
TYPE	- M1: Recessed Direct Only
OPTICAL SYSTEM	- L: Lens Louver
SURFACE FINISH	- E: Silver Anodised
CONTROL GEAR	- E: On/Off, L: DALI, D: 1-10V, H: Touch-Dim, A: Casambi Micro
COLOUR REND.	- 8: CRI>80
COLOUR TEMP.	- 27: 2700K, 30: 3000K, 40: 4000K
POWER	- E: Low Power, M: Medium Power
SIZE	- Luminaire length in mm: L669, L953, L1237, L1521, L1805
INSTALLATION	- F: Installation Housing
REFLECTOR	- W: Snow White, C: Specular Chrome, B: Jet Black, A: Satin Silver, H: Champagne Silver, K: Satin Copper, N: Satin Platinum, G: Satin Gold

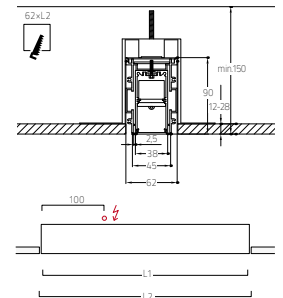

MATRIC 38 mm  
RECESSED FRAMELESS | M1



**DE** LED-Einbauleuchte für rahmenlose Montage in Gipskartondecken. Rein direktstrahlend. Lichtkanal aus Aluminiumprofil mit 38mm Lichtspur-Breite. Millimetergenaue Längenfertigung nach Vorgabe möglich. Oberfläche naturelxiert. Microprismenoptik mit optimierter Blendungsbegrenzung speziell für Office-Anwendungen. Satinierter Opaldiffusor für Allgemeinbeleuchtung. Wallwasher für homogene vertikale Beleuchtung. Konverter in Leuchtgehäuse integriert, wahlweise einfach schaltbar oder stufenlos dimmbar (1-10V, DALI, Touch-Dim, Casambi). Farbtemperaturen 2200K, 2700K, 3000K, 3500K, 4000K oder 6500K. Binning initial  $\leq$  MacAdam 3. Farbwiedergabe CRI>80 oder CRI>90. Einbaurahmen für Montage mit Schattenspalz vorab lieferbar; restliche Leuchtenkomponenten zeitlich versetzt montierbar. Einbaurahmen und Befestigungsset inklusive. Auf Anfrage: Integration von Notlichtkomponenten, Sensortechnologie sowie Vielzahl weiterer Optionen.

**EN** Recessed mounted LED luminaire for frameless installation in plasterboard ceilings. Direct only light distribution. Light channel made of aluminium profile with 38mm profile width. Precise length production according to specifications possible. Surface natural anodised. Microprismatic screen with optimized glare reduction especially for workplaces. Satin opal diffuser for general lighting. Wallwasher for homogeneous vertical illuminance. Driver integrated into luminaire housing, optionally switchable or dimmable (1-10V, DALI, Touch-Dim, Casambi). Colour temperatures 2200K, 2700K, 3000K, 3500K, 4000K or 6500K. Binning initial  $\leq$  MacAdam 3. Colour rendering CRI>80 or CRI>90. Mounting frame for installation with shadow gap available in advance; other luminaire components can be mounted later. Mounting frame and mounting brackets included. On request: Integration of emergency lighting components, sensor technology as well as many other options.

**FR** Luminaire LED encastré sans cadre pour plafonds en placoplâtre. Éclairage seulement direct. Rail lumineux en profilé d'aluminium avec une largeur d'éclairage de 38 mm. Fabrication au millimètre près des longueurs selon les spécifications. Surface anodisée. Diffuseur microprismatique optimisé pour un éblouissement limité et adapté aux bureaux. Diffuseur opale satinée pour un éclairage général. Wallwasher pour un éclairage vertical homogène. Driver intégré dans le luminaire, au choix ON /OFF ou graduable (1-10V, DALI, Touch-Dim, Casambi). Température de couleur 2200K, 2700K, 3000K, 3500K, 4000K ou 6500K. Binning initial  $\leq$  MacAdam 3. Rendu de couleur CRI>80 ou CRI>90. Cadre de montage encastré livrable et disponible en avance; montage possible des éléments du luminaire restants, ultérieurement. Cadre de montage et kit de fixations inclus. Sur demande: Intégration de composants d'éclairage de secours ou de capteurs ainsi qu'une multitude d'autres options.

Installation Housing with Shadow Gap

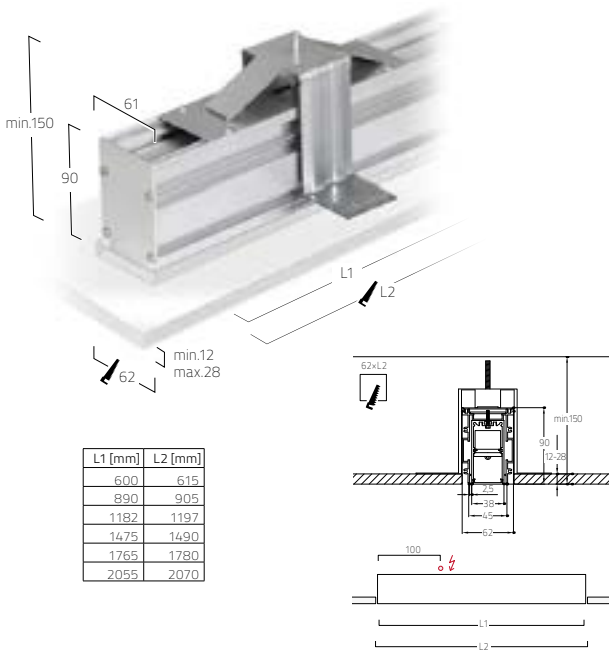

**PRODUCT-CODE:** L M 1 O E E - 8 30 M - L890 - F

- PRODUCT FAMILY – L: Matric
- TYPE – M1: Recessed Direct Only
- OPTICAL SYSTEM – H: Microprismatic Plus, A: Microprismatic, O: Opal, G: Wallwasher
- SURFACE FINISH – E: Silver Anodised
- CONTROL GEAR – E: On/Off, L: DALI, D: 1-10V, H: Touch-Dim, A: Casambi Micro
- COLOUR REND. – 8: CRI>80, 9: CRI>90, F: Full Spectrum
- COLOUR TEMP. – 22: 2200K, 27: 2700K, 30: 3000K, 35: 3500K, 40: 4000K, 65: 6500K, TW: Tunable White 2700-6500K [L890-L2055]
- POWER – M: Medium Power, H: High Power
- SIZE – Luminaire length in mm: L600, L890, L1182, L1475, L1765, L2055
- INSTALLATION – F: Installation Housing
- ON REQUEST – Special Length Versions, 90°-Elements, Magnetic Track, 3-Phase Track, Midpin Spotlights, Lens Louver-Inset, Emergency Module, Multisensor



MICROPRISMATIC PLUS

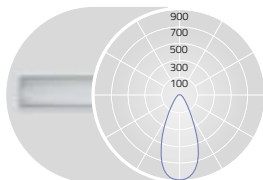

UGRs 19 (X=4H, Y=8H, S=0.25H)  
DIRECT 100%

L mm	Lumen/Watt Medium Power
600	820lm/8W
890	1240lm/12W
1182	1650lm/15W
1475	2060lm/17W
1765	2480lm/20W
2055	2880lm/23W

MICROPRISMATIC

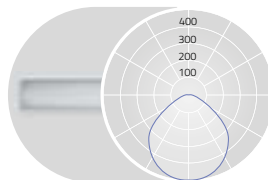

DIRECT 100%

L mm	Lumen/Watt Medium Power	Lumen/Watt High Power
600	840lm/9W	1130lm/12W
890	1260lm/13W	1700lm/17W
1182	1680lm/16W	2270lm/22W
1475	2100lm/20W	2840lm/26W
1765	2520lm/23W	3400lm/31W
2055	2940lm/26W	3970lm/35W

OPAL

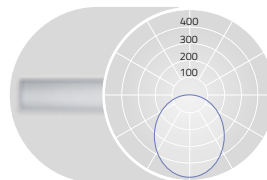

DIRECT 100%

L mm	Lumen/Watt Medium Power	Lumen/Watt High Power
600	900lm/9W	1220lm/12W
890	1350lm/13W	1830lm/17W
1182	1810lm/16W	2440lm/22W
1475	2260lm/20W	3050lm/26W
1765	2710lm/23W	3660lm/31W
2055	3160lm/26W	4270lm/35W

WALLWASHER

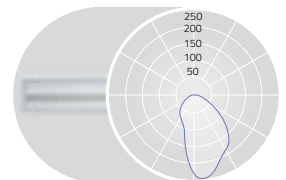

DIRECT 100%

L mm	Lumen/Watt Medium Power	Lumen/Watt High Power
600	880lm/9W	1180lm/12W
890	1310lm/13W	1780lm/17W
1182	1750lm/16W	2370lm/22W
1475	2190lm/20W	2960lm/26W
1765	2630lm/23W	3550lm/31W
2055	3070lm/26W	4140lm/35W

Lumen Values: Luminaire luminous flux at 4000K/CRI>80. Other configurations on request.



# MATRIC 38 mm LENS LOUVER RECESSED FRAME | F1

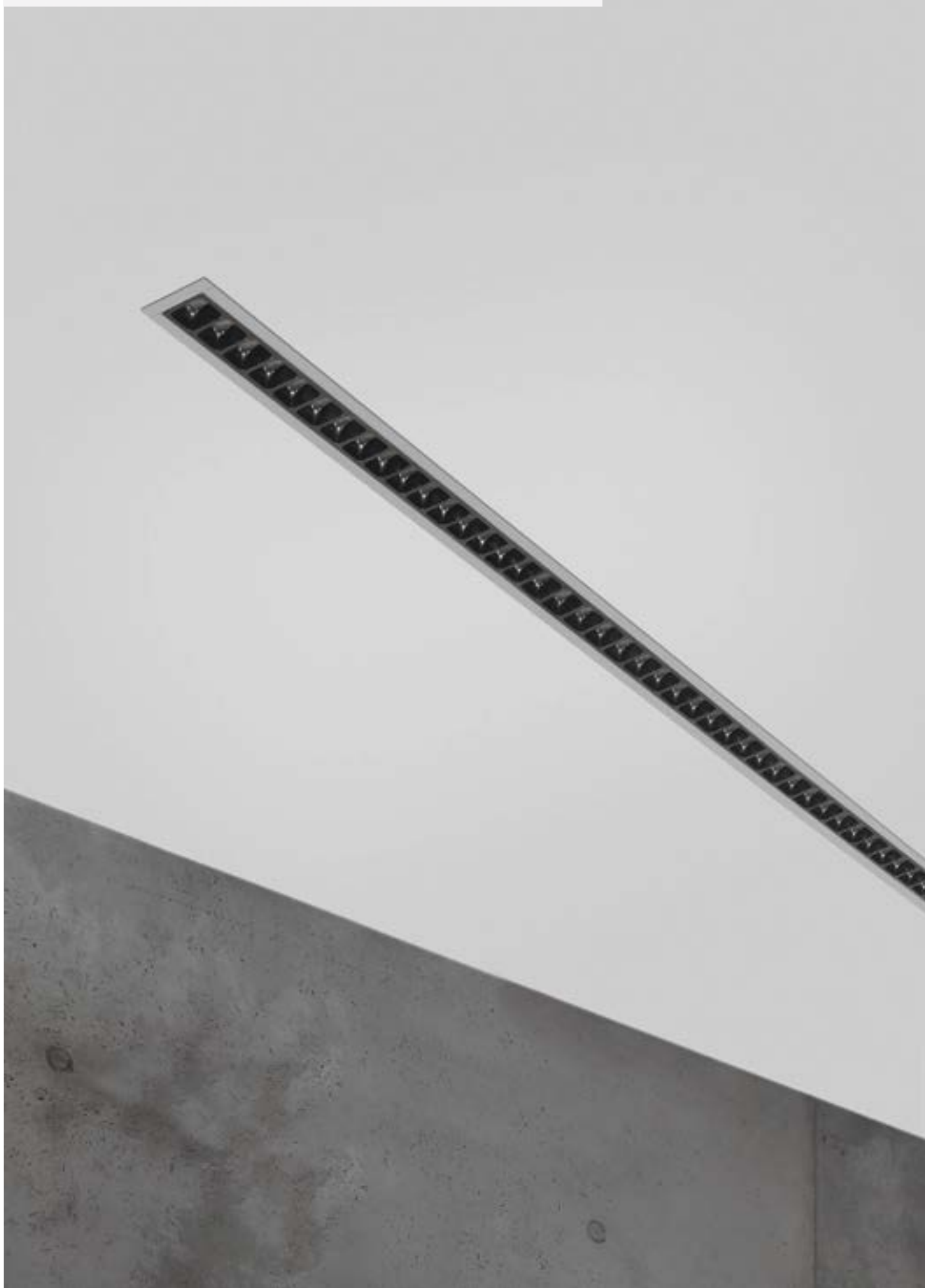

**DE** LED-Einbauleuchte mit umlaufendem Rahmen für Montage in gesägten Deckenöffnungen. Rein direkt-strahlend. Lichtkanal aus Aluminiumprofil mit 38mm Lichtspur-Breite. Millimetergenaue Längenfertigung nach Vorgabe möglich. Oberfläche natureloxiert oder weiß, graphit, schwarz, champagner oder kupferfarben lackiert. Weitere Oberflächenoptionen siehe Lightnet-Surface-Collection oder RAL nach Wahl. Präzisionslinsen mit Abblenderaster für breite rotationssymmetrische Lichtstärkeverteilung bei gleichzeitig hoher Blendungsbegrenzung (UGR<16). Raster in verschiedenen Farbausführung erhältlich. Konverter in Leuchtengehäuse integriert, wahlweise einfach schaltbar oder stufenlos dimmbar (1-10V, DALI, Touch-Dim, Casambi). Farbtemperaturen 2700K, 3000K oder 4000K. Binning initial  $\leq$  MacAdam 3. Farbwiedergabe CRI>80. Befestigungsset inklusive. Leuchtenprofil für Montage vorab lieferbar; restliche Leuchtenkomponenten zeitlich versetzt montierbar. Auf Anfrage: Integration von Notlichtkomponenten, Sensortechnologie sowie Vielzahl weiterer Optionen.

**EN** Recessed mounted LED luminaire with surrounding frame for installation in ceilings with cut-out openings. Direct only light distribution. Light channel made of aluminium profile with 38mm profile width. Precise length production according to specifications possible. Surface natural anodised or white, graphite, black, champagne or copper coated. Further surface options see Lightnet-Surface-Collection or RAL of your choice. Precision lenses with louvre for wide rotationally symmetrical light distribution with high glare limitation (UGR<16). Louvre available in various colour combinations. Driver integrated into luminaire housing, optionally switchable or dimmable (1-10V, DALI, Touch-Dim, Casambi). Colour temperature 2700K, 3000K or 4000K. Binning initial  $\leq$  MacAdam 3. Colour rendering CRI>80. Mounting brackets included. Luminaire profile available in advance for mounting; other luminaire components can be mounted later. On request: Integration of emergency lighting components, sensor technology as well as many other options.

**FR** Luminaire encastré LED avec cadre-colerette pour montage dans plafonds à découpes. Éclairage seulement direct. Rail lumineux en profilé d'aluminium avec une largeur d'éclairage de 38 mm. Fabrication au millimètre près des longueurs selon les spécifications. Surface anodisée ou laquée blanc, graphite, noir, champagne ou cuivre. Autres options de finition voir Lightnet-Surface-Collection ou RAL au choix. Lentilles de précision avec grille antiéblouissement pour une large répartition symétrique de l'intensité lumineuse et facteur d'antiéblouissement très bas (UGR<16). Grille antiéblouissement disponible en plusieurs combinaisons de couleurs. Driver intégré dans le luminaire, au choix ON/OFF ou graduable (1-10V, DALI, Touch-Dim, Casambi). Température de couleur 2700K, 3000K ou 4000K. Binning initial  $\leq$  MacAdam 3. Rendu de couleur CRI>80. Cadre de montage et kit de fixations inclus. Cadre de montage en encastré ou profilé vide livrable et disponible en avance; montage possible des composants restants du luminaire, ultérieurement. Sur demande: Intégration de composants d'éclairage de secours ou de capteurs ainsi qu'une multitude d'autres options.

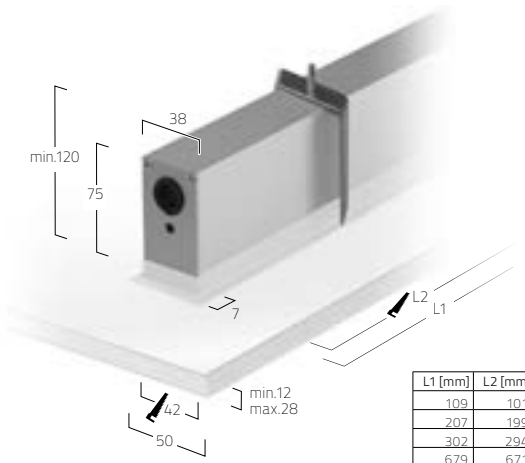

L1 [mm]	L2 [mm]
109	101
207	199
302	294
679	671
963	955
1247	1239
1531	1523
1815	1807

**PRODUCT-CODE:** L F1 L E E - 8 30 M - L963 - B

- PRODUCT FAMILY - L: Matric
- TYPE - F1: Recessed Direct Only
- OPTICAL SYSTEM - L: Lens Louver
- SURFACE FINISH - W: Snow White, E: Silver Anodised, U: Urban Graphite, B: Jet Black, H: Champagne Silver, K: Satin Copper
- CONTROL GEAR - E: On/Off, L: DALI, D: 1-10V, H: Touch-Dim, A: Casambi Micro
- COLOUR REND. - 8: CRI>80
- COLOUR TEMP. - 27: 2700K, 30: 3000K, 40: 4000K
- POWER - E: Low Power, M: Medium Power
- SIZE - Luminaire length in mm: L109, L207, L302, L679, L963, L1247, L1531, L1815
- REFLECTOR - W: Snow White, C: Specular Chrome, B: Jet Black, A: Satin Silver, H: Champagne Silver, K: Satin Copper, N: Satin Platinum, G: Satin Gold



LENS LOUVER DIRECT ONLY

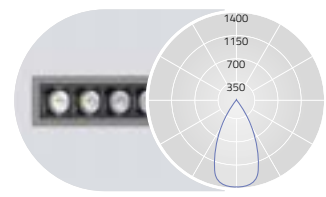

UGR<16 (X=4H, Y=8H, S=0.25H) DIRECT: 100%

L mm	Lumen/Watt Low Power	Lumen/Watt Medium Power
109	180lm/4W	290lm/5W
207	360lm/6W	580lm/8W
302	540lm/8W	870lm/11W
679	1260lm/15W	2030lm/24W
963	1800lm/20W	2900lm/33W
1247	2340lm/25W	3770lm/42W
1531	2880lm/31W	4640lm/52W
1815	3420lm/36W	5510lm/61W

Lumen Values: Luminaire luminous flux at 4000K/CRI>80. Other configurations on request.



REMOTE DRIVER FOR L109-L302





MATRIC 38 MM  
RECESSED FRAME | F1



**DE** LED-Einbauleuchte mit umlaufendem Rahmen für Montage in gesägten Deckenöffnungen. Rein direktstrahlend. Lichtkanal aus Aluminiumprofil mit 38mm Lichtspur-Breite. Millimetergenaue Längenfertigung nach Vorgabe möglich. Oberfläche naturelxiert oder weiß, graphit, schwarz, champagner oder kupferfarben lackiert. Weitere Oberflächenoptionen siehe Lightnet-Surface-Collection oder RAL nach Wahl. Microprismenoptik mit optimierter Blendungsbegrenzung speziell für Office-Anwendungen. Satinierter Opaldiffusor für Allgemeinbeleuchtung. Wallwasher für homogene vertikale Beleuchtung. Konverter in Leuchtgehäuse integriert, wahlweise einfach schaltbar oder stufenlos dimmbar (1-10V, DALI, Touch-Dim, Casambi). Farbtemperaturen 2200K, 2700K, 3000K, 3500K, 4000K oder 6500K. Binning initial  $\leq$  MacAdam 3. Farbwiedergabe CRI>80 oder CRI>90. Befestigungsset inklusive. Leuchtenprofil für Montage vorab lieferbar; restliche Leuchtenkomponenten zeitlich versetzt montierbar.

**EN** Recessed mounted LED luminaire with surrounding frame for installation in ceilings with cut-out openings. Direct only light distribution. Light channel made of aluminium profile with 38mm track width. Precise length production according to specifications possible. Surface natural anodised or white, graphite, black, champagne or copper coated. Further surface options see Lightnet-Surface-Collection or RAL of your choice. Microprismatic screen with optimized glare reduction especially for workplaces. Satin opal diffuser for general lighting. Wallwasher for homogeneous vertical illumination. Converter integrated into luminaire housing, optionally switchable or dimmable (1-10V, DALI, Touch-Dim, Casambi). Colour temperatures 2200K, 2700K, 3000K, 3500K, 4000K or 6500K. Binning initial  $\leq$  MacAdam 3. Colour rendering CRI>80 or CRI>90. Mounting brackets included. Luminaire profile available in advance for mounting; other luminaire components can be mounted at different times.

**FR** Luminaire encastré LED avec cadre-colerette pour montage dans plafonds à découpes. Éclairage seulement direct. Rail lumineux en profilé d'aluminium avec une largeur d'éclairage de 38 mm. Fabrication au millimètre près des longueurs selon les spécifications. Surface anodisée ou laquée blanc, graphite, noir, champagne ou cuivre. Autres options de finition voir Lightnet-Surface-Collection ou RAL au choix. Diffuseur microprismatique optimisé pour un éblouissement limité et adapté aux bureaux. Diffuseur opale satinée pour un éclairage général. Wallwasher pour un éclairage vertical homogène. Driver intégré dans le luminaire, au choix ON/OFF ou graduable (1-10V, DALI, Touch-Dim, Casambi). Température de couleur 2200K, 2700K, 3000K, 3500K, 4000K ou 6500K. Binning initial  $\leq$  MacAdam 3. Rendu de couleur CRI>80 ou CRI>90. Cadre de montage et kit de fixations inclus. Cadre de montage en encastré ou profilé vide livrable et disponible en avance; montage possible des composants restants du luminaire, ultérieurement.

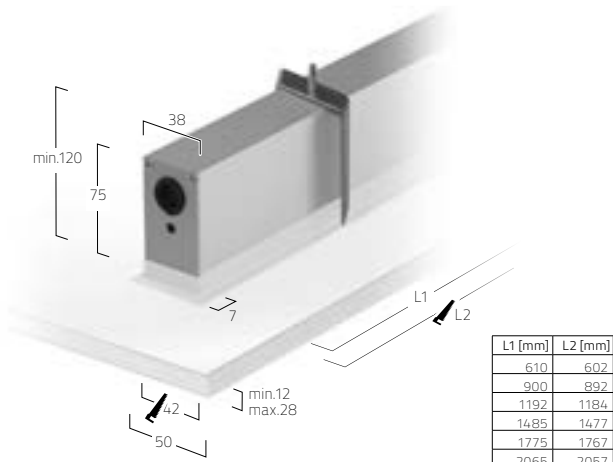

**PRODUCT-CODE:** L F1 O E E - 8 30 M - L900

- PRODUCT FAMILY - L: Matrix
- TYPE - F1: Recessed Direct Only
- OPTICAL SYSTEM - H: Microprismatic Plus, A: Microprismatic, O: Opal, G: Wallwasher
- SURFACE FINISH - W: Snow White, E: Silver Anodised, U: Urban Graphite, B: Jet Black, H: Champagne Silver, K: Satin Copper
- CONTROL GEAR - E: On/Off, L: DALI, D: 1-10V, H: Touch-Dim, A: Casambi Micro
- COLOUR REND. - 8: CRI>80, 9: CRI>90, F: Full Spectrum
- COLOUR TEMP. - 22: 2200K, 27: 2700K, 30: 3000K, 35: 3500K, 40: 4000K, 65: 6500K, TW: Tunable White 2700-6500K [L900-L2065]
- POWER - M: Medium Power, H: High Power
- SIZE - Luminaire length in mm: L610, L900, L1192, L1485, L1775, L2065
- ON REQUEST - Special Length Versions, 90°-Elements, Magnetic Track, 3-Phase Track, Midpin Spotlights, Lens Louver-Inset, Emergency Module, Multisensor

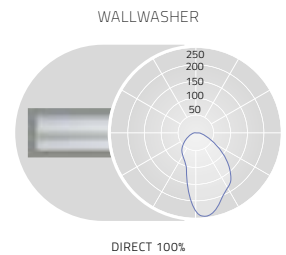
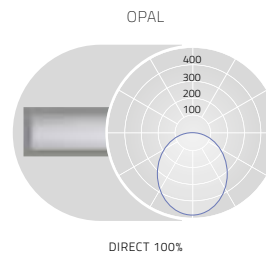
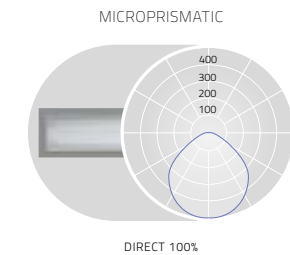
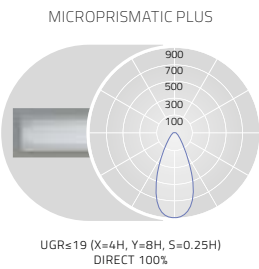

L mm	Lumen/Watt Medium Power
610	820lm/8W
900	1240lm/12W
1192	1650lm/15W
1485	2060lm/17W
1775	2480lm/20W
2065	2880lm/23W

L mm	Lumen/Watt Medium Power	Lumen/Watt High Power
610	840lm/9W	1130lm/12W
900	1260lm/13W	1700lm/17W
1192	1680lm/16W	2270lm/22W
1485	2100lm/20W	2840lm/26W
1775	2520lm/23W	3400lm/31W
2065	2940lm/26W	3970lm/35W

L mm	Lumen/Watt Medium Power	Lumen/Watt High Power
610	900lm/9W	1220lm/12W
900	1350lm/13W	1830lm/17W
1192	1810lm/16W	2440lm/22W
1485	2260lm/20W	3050lm/26W
1775	2710lm/23W	3660lm/31W
2065	3160lm/26W	4270lm/35W

L mm	Lumen/Watt Medium Power	Lumen/Watt High Power
610	880lm/9W	1180lm/12W
900	1310lm/13W	1780lm/17W
1192	1750lm/16W	2370lm/22W
1485	2190lm/20W	2960lm/26W
1775	2630lm/23W	3550lm/31W
2065	3070lm/26W	4140lm/35W

Lumen Values: Luminaire luminous flux at 4000K/CRI>80. Other configurations on request.

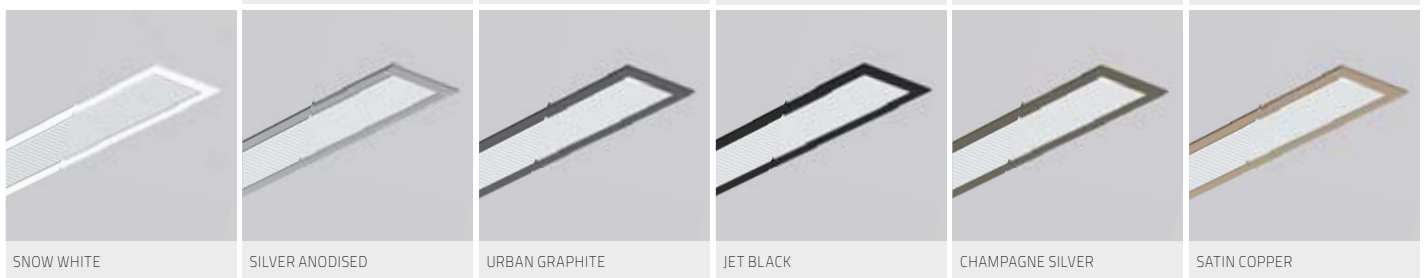

MATRIC 55 MM  
RECESSED FRAMELESS | M3



**DE** LED-Einbauleuchte für rahmenlose Montage in Gipskartondecken. Rein direktstrahlend. Lichtkanal aus Aluminiumprofil mit 55mm Lichtspur-Breite. Millimetergenaue Längenfertigung nach Vorgabe möglich. Oberfläche natureloxiert. Microprismenoptik und Satin-Louver für Office-Anwendungen. Opaldiffusor aus satiniertem Acrylglas für Allgemeinbeleuchtung. Wallwisher für homogene vertikale Beleuchtung. Konverter in Leuchtgehäuse integriert, wahlweise einfach schaltbar oder stufenlos dimmbar (1-10V, DALI, Touch-Dim, Casambi). Farbtemperaturen 2200K, 2700K, 3000K, 3500K, 4000K oder 6500K. Binning initial ≤ MacAdam 3. Farbwiedergabe CRI>80 oder CRI>90. Wahlweise Einbaurahmen für Installation mit Schattenfuge, alternativ Befestigungsset für Installation ohne Schattenfuge. Einbaurahmen oder Leuchtenprofil für Montage vorab lieferbar; restliche Leuchtenkomponenten zeitlich versetzt montierbar. Auf Anfrage: Integration von Notfallkomponenten, Sensortechnologie sowie Vielzahl weiterer Optionen.

**EN** Recessed mounted LED luminaire for frameless installation in plasterboard ceilings. Direct only light distribution. Light channel made of aluminium profile with 55mm track width. Precise length production according to specifications possible. Surface natural anodised. Microprismatic screen and satin louver for office purposes. Opal diffuser made of acrylic glass for general lighting. Wallwasher for homogeneous vertical illumination. Converter integrated into luminaire housing, optionally switchable or dimmable (1-10V, DALI, Touch-Dim, Casambi). Colour temperatures 2200K, 2700K, 3000K, 3500K, 4000K or 6500K. Binning initial ≤ MacAdam 3. Colour rendering CRI>80 or CRI>90. Optional mounting frame for installation with shadow gap, alternative mounting brackets for installation without shadow gap. Mounting frame or luminaire profile available in advance for mounting; other luminaire components can be mounted at different times. On request: Integration of emergency lighting components, sensor technology as well as many other options.

**FR** Luminaire LED encastré sans cadre pour plafonds en placoplâtre. Éclairage seulement direct. Rail lumineux en profilé d'aluminium avec une largeur d'éclairage de 55mm. Fabrication au millimètre près des longueurs selon les spécifications. Surface anodisée. Optique microprismatique et satin louver pour postes de travail. Diffuseur opale en verre acrylique pour éclairage général. Wallwasher pour un éclairage vertical homogène. Driver intégré dans le luminaire, au choix ON/OFF ou graduable (1-10V, DALI, Touch-Dim, Casambi). Température de couleur 2200K, 2700K, 3000K, 3500K, 4000K ou 6500K. Binning initial ≤ MacAdam 3. Rendu de couleur CRI>80 ou CRI>90. Installation en encastré au choix avec cadre de montage, ou alternative avec kit de fixation/étriers. Cadre de montage en encastré ou profilé vide livrable et disponible en avance; montage possible des composants restants du luminaire, ultérieurement. Sur demande: Intégration de composants d'éclairage de secours ou de capteurs ainsi qu'une multitude d'autres options.

Installation Bracket without Shadow Gap

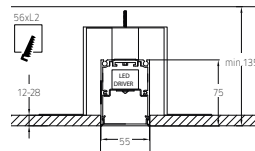
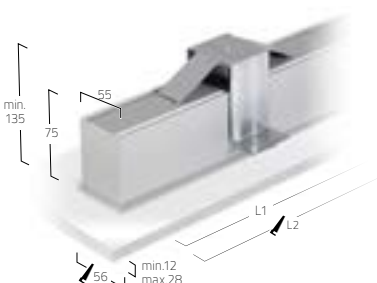

L1 [mm]	L3 [mm]
600	601
890	891
1182	1183
1475	1476
1765	1766
2055	2056

Installation Housing with Shadow Gap

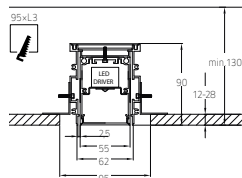
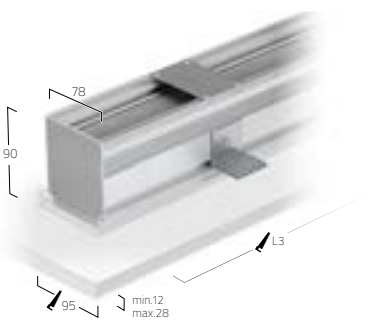

**PRODUCT-CODE:** L M3 O E E - 8 30 M - L890 - F

PRODUCT FAMILY - L: Matrix  
 TYPE - M3: Recessed Direct Only  
 OPTICAL SYSTEM - O: Opal, A: Microprismatic, G: Wallwasher, M: Satin Louver  
 SURFACE FINISH - E: Silver Anodised  
 CONTROL GEAR - E: On/Off, L: DALI, D: 1-10V, H: Touch-Dim, C: Casambi  
 COLOUR REND. - 8: CRI>80, 9: CRI>90, F: Full Spectrum  
 COLOUR TEMP. - 22: 2200K, 27: 2700K, 30: 3000K, 35: 3500K, 40: 4000K, 65: 6500K, TW: Tunable White 2700-6500K [L890-L2055]  
 POWER - E: Low Power, M: Medium Power, H: High Power  
 SIZE - Luminaire length in mm: L600, L890, L1182, L1475, L1765, L2055  
 INSTALLATION - F: Installation Housing, B: Installation Brackets  
 ON REQUEST - Special Length Versions, 90°-Corner, 3-Phase Track, Midpin&Midpoint Spotlights/Downlights, Emergency Module, Multisensor

IP20	~220-240V	50-60 Hz	IK 02	RG0 EN 62471	≤3 MacAdam	LOW POWER L80810 = 50000K	MEDIUM POWER L88810 = 50000K	HIGH POWER L80810 = 50000K	CE
------	-----------	----------	-------	--------------	------------	---------------------------	------------------------------	----------------------------	----

L1 [mm]	L3 [mm]
600	615
890	905
1182	1197
1475	1490
1765	1780
2055	2070

MICROPRISMATIC

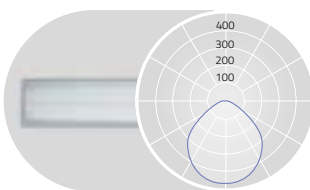

UGR<math>\leq 19</math> for Low Power (X=4H, Y=8H, S=0.25H) DIRECT 100%

OPAL

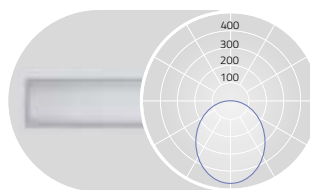

DIRECT 100%

SATIN LOUVER

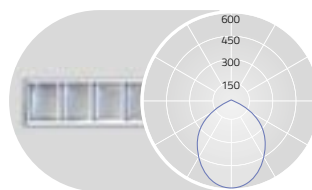

UGR<math>\leq 19</math> for Medium Power (X=4H, Y=8H, S=0.25H) DIRECT 100%

WALLWASHER

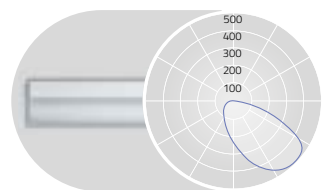

DIRECT 100%

L mm	Lumen/Watt Low Power	Lumen/Watt Medium Power	Lumen/Watt High Power
600	780lm/8W	1300lm/13W	1890lm/19W
890	1170lm/12W	1950lm/19W	2830lm/28W
1182	1560lm/15W	2600lm/24W	3780lm/36W
1475	1950lm/17W	3250lm/29W	4720lm/44W
1765	2340lm/20W	3900lm/34W	5670lm/52W
2055	2730lm/23W	4550lm/39W	6610lm/58W

L mm	Lumen/Watt Low Power	Lumen/Watt Medium Power	Lumen/Watt High Power
600	830lm/8W	1390lm/13W	2010lm/19W
890	1250lm/12W	2080lm/19W	3020lm/28W
1182	1660lm/15W	2770lm/24W	4030lm/36W
1475	2080lm/17W	3470lm/29W	5040lm/44W
1765	2490lm/20W	4160lm/34W	6040lm/52W
2055	2910lm/23W	4850lm/39W	7050lm/58W

L mm	Lumen/Watt Medium Power	Lumen/Watt High Power
600	940lm/13W	1360lm/19W
890	1400lm/19W	2040lm/28W
1182	1870lm/24W	2720lm/36W
1475	2340lm/29W	3400lm/44W
1765	2810lm/34W	4080lm/52W
2055	3270lm/39W	4760lm/58W

L mm	Lumen/Watt Medium Power	Lumen/Watt High Power
600	780lm/11W	1070lm/15W
890	1170lm/16W	1600lm/21W
1182	1560lm/20W	2140lm/27W
1475	1950lm/24W	2670lm/33W
1765	2340lm/28W	3210lm/39W
2055	2730lm/31W	3740lm/44W

Lumen Values: Luminaire luminous flux at 4000K/CRI>80. Other configurations on request.



MATRIC 55<sub>MM</sub>  
RECESSED FRAME | F3



**DE** LED-Einbauleuchte mit umlaufendem Rahmen für Montage in gesägten Deckenöffnungen. Rein direktstrahlend. Lichtkanal aus Aluminiumprofil mit 55mm Lichtspur-Breite. Millimetergenaue Längenfertigung nach Vorgabe möglich. Oberfläche naturelxiert oder weiß, graphit, schwarz, champagner oder kupferfarben lackiert. Weitere Oberflächenoptionen siehe Lightnet-Surface-Collection oder RAL nach Wahl. Microprismenoptik und Satin-Louver für Office-Anwendungen. Opaldiffusor aus satiniertem Acrylglas für Allgemeinbeleuchtung. Wallwasher für homogene vertikale Beleuchtung. Konverter in Leuchtgehäuse integriert, wahlweise einfach schaltbar oder stufenlos dimmbar (1-10V, DALI, Touch-Dim, Casambi). Farbtemperaturen 2200K, 2700K, 3000K, 3500K, 4000K oder 6500K. Binning initial  $\leq$  MacAdam 3. Farbwiedergabe CRI>80 oder CRI>90. Befestigungsset inklusive. Leuchtenprofil für Montage vorab lieferbar; restliche Leuchtenkomponenten zeitlich versetzt montierbar.

**EN** Recessed mounted LED luminaire with surrounding frame for installation in ceilings with cut-out openings. Direct only light distribution. Light channel made of aluminium profile with 55mm track width. Precise length production according to specifications possible. Surface natural anodised or white, graphite, black, champagne or copper coated. Further surface options see Lightnet-Surface-Collection or RAL of your choice. Microprismatic screen and satin louver for office purposes. Opal diffuser made of acrylic glass for general lighting. Wallwasher for homogeneous vertical illuminance. Converter integrated into luminaire housing, optionally switchable or dimmable (1-10V, DALI, Touch-Dim, Casambi). Colour temperatures 2200K, 2700K, 3000K, 3500K, 4000K or 6500K. Binning initial  $\leq$  MacAdam 3. Colour rendering CRI>80 or CRI>90. Mounting brackets included. Luminaire profile available in advance for mounting; other luminaire components can be mounted at different times.

**FR** Luminaire encastré LED avec cadre-colerette pour montage dans plafonds à découpes. Éclairage seulement direct. Rail lumineux en profilé d'aluminium avec une largeur d'éclairage de 55mm. Fabrication au millimètre près des longueurs selon les spécifications. Surface anodisée ou laquée blanc, graphite, noir, champagne ou cuivre. Autres options de finition voir Lightnet-Surface-Collection ou RAL au choix. Optique microprismatique et satin louver pour postes de travail. Diffuseur opale en verre acrylique pour éclairage général. Wallwasher pour un éclairage vertical homogène. Driver intégré dans le luminaire, au choix ON/OFF ou graduable (1-10V, DALI, Touch-Dim, Casambi). Température de couleur 2200K, 2700K, 3000K, 3500K, 4000K ou 6500K. Binning initial  $\leq$  MacAdam 3. Rendu de couleur CRI>80 ou CRI>90. Cadre de montage et kit de fixations inclus. Cadre de montage en encastré ou profilé vide livrable et disponible en avance; montage possible des composants restants du luminaire, ultérieurement.

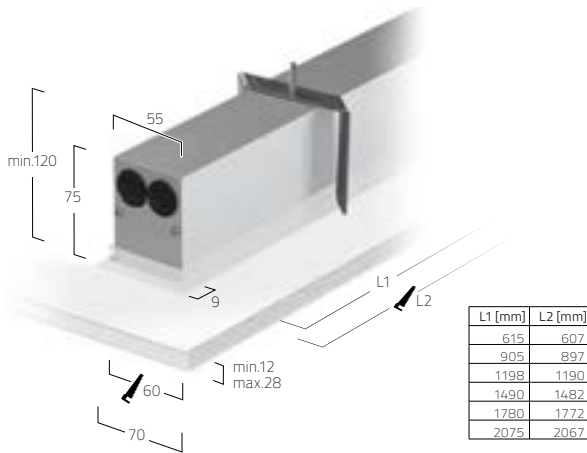

**PRODUCT-CODE:** L F3 O E E - 8 30 M - L905

- PRODUCT FAMILY - L: Matrix
- TYPE - F3: Recessed Direct Only
- OPTICAL SYSTEM - O: Opal, A: Microprismatic, M: Satin Louver, G: Wallwasher
- SURFACE FINISH - W: Snow White, E: Silver Anodised, U: Urban Graphite, B: Jet Black, H: Champagne Silver, K: Satin Copper
- CONTROL GEAR - E: On/Off, L: DALI, D: 1-10V, H: Touch-Dim, C: Casambi
- COLOUR REND. - 8: CRI>80, 9: CRI>90, F: Full Spectrum
- COLOUR TEMP. - 22: 2200K, 27: 2700K, 30: 3000K, 35: 3500K, 40: 4000K, 65: 6500K, TW: Tunable White 2700-6500K [L905-L2075]
- POWER - E: Low Power, M: Medium Power, H: High Power
- SIZE - Luminaire length in mm: L615, L905, L1198, L1490, L1780, L2075
- ON REQUEST - Special Length Versions, 90°-Corner, 3-Phase Track, Midpin&Midpoint Spotlights/Downlights, Emergency Module, Multisensor

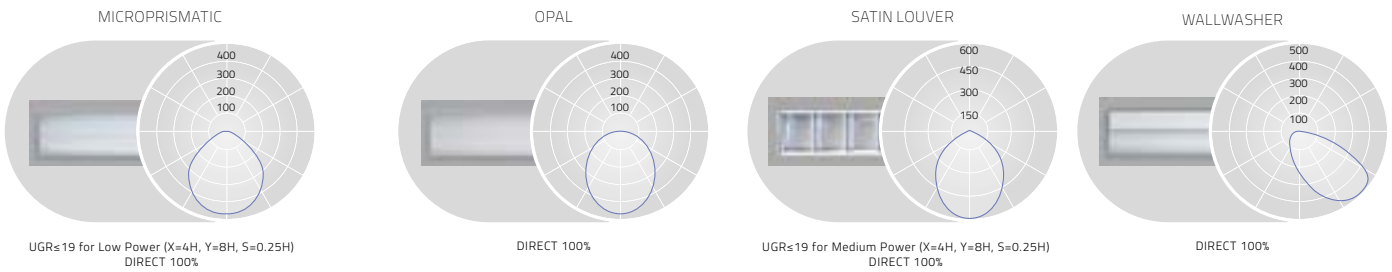

L mm	MICROPRISMATIC			OPAL			SATIN LOUVER		WALLWASHER	
	Lumen/Watt Low Power	Lumen/Watt Medium Power	Lumen/Watt High Power	Lumen/Watt Low Power	Lumen/Watt Medium Power	Lumen/Watt High Power	Lumen/Watt Medium Power	Lumen/Watt High Power	Lumen/Watt Medium Power	Lumen/Watt High Power
615	780lm/8W	1300lm/13W	1890lm/19W	830lm/8W	1390lm/13W	2010lm/19W	940lm/13W	1360lm/19W	780lm/11W	1070lm/15W
905	1170lm/12W	1950lm/19W	2830lm/28W	1250lm/12W	2080lm/19W	3020lm/28W	1400lm/19W	2040lm/28W	1170lm/16W	1600lm/21W
1198	1560lm/15W	2600lm/24W	3780lm/36W	1660lm/15W	2770lm/24W	4030lm/36W	1870lm/24W	2720lm/36W	1560lm/20W	2140lm/27W
1490	1950lm/17W	3250lm/29W	4720lm/44W	2080lm/17W	3470lm/29W	5040lm/44W	2340lm/29W	3400lm/44W	1950lm/24W	2670lm/33W
1780	2340lm/20W	3900lm/34W	5670lm/52W	2490lm/20W	4160lm/34W	6040lm/52W	2810lm/34W	4080lm/52W	2340lm/28W	3210lm/39W
2075	2730lm/23W	4550lm/39W	6610lm/58W	2910lm/23W	4850lm/39W	7050lm/58W	3270lm/39W	4760lm/58W	2730lm/31W	3740lm/44W

Lumen Values: Luminaire luminous flux at 4000K/CRI>80. Other configurations on request.



# MATRIC 81 MM RECESSED FRAMELESS | M5

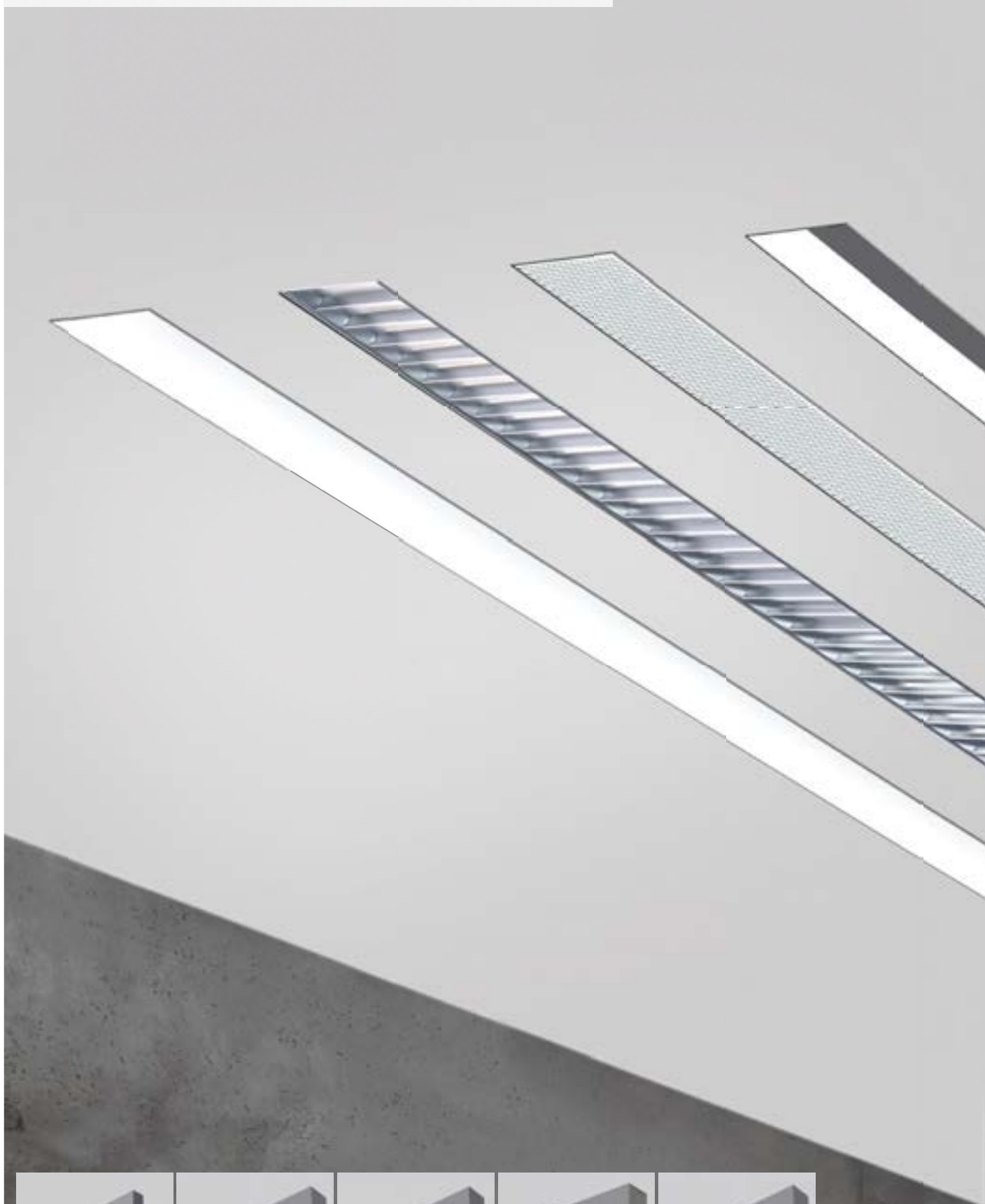

**DE** LED-Einbauleuchte für rahmenlose Montage in Gipskartondecken. Rein direktstrahlend. Lichtkanal aus Aluminiumprofil mit 81mm Lichtspur-Breite. Millimetergenaue Längenfertigung nach Vorgabe möglich. Oberfläche natureloxiert. Microprismenoptik und Satin-Louver mit optimierter Blendungsbegrenzung speziell für Office-Anwendungen. Opaldiffusor aus satinierem Acrylglas für Allgemeinbeleuchtung. Wallwasher für homogene vertikale Beleuchtung. Konverter in Leuchtengehäuse integriert, wahlweise einfach schaltbar oder stufenlos dimmbar (1-10V, DALI, Touch-Dim, Casambi). Farbtemperaturen 2200K, 2700K, 3000K, 3500K, 4000K oder 6500K. Binning initial  $\leq$  MacAdam 3. Farbwiedergabe CRI>80 oder CRI>90. Wahlweise Einbaurahmen für Installation mit Schattenfuge, alternativ Befestigungsset für Installation ohne Schattenfuge. Einbaurahmen oder Leuchtenprofil für Montage vorab lieferbar; restliche Leuchtenkomponenten zeitlich versetzt montierbar.

**EN** Recessed mounted LED luminaire for frameless installation in plasterboard ceilings. Direct only light distribution. Light channel made of aluminium profile with 81mm track width. Precise length production according to specifications possible. Surface natural anodised. Microprismatic screen and satin louver with optimized glare limitation especially for office purposes. Opal diffuser made of acrylic glass for general lighting. Wallwasher for homogeneous vertical illuminance. Converter integrated into luminaire housing, optionally switchable or dimmable (1-10V, DALI, Touch-Dim, Casambi). Colour temperatures 2200K, 2700K, 3000K, 3500K, 4000K or 6500K. Binning initial  $\leq$  MacAdam 3. Colour rendering CRI>80 or CRI>90. Optional mounting frame for installation with shadow gap, alternative mounting brackets for installation without shadow gap. Mounting frame or luminaire profile available in advance for mounting; other luminaire components can be mounted at different times.

**FR** Luminaire LED encastré sans cadre pour plafonds en placoplâtre. Éclairage seulement direct. Rail lumineux en profilé d'aluminium avec une largeur d'éclairage de 81mm. Fabrication au millimètre près des longueurs selon les spécifications. Surface anodisée. Diffuseur microprismatique ou Satin-Louver avec une limitation optimisée de l'éblouissement pour les postes de travail. Diffuseur opale en verre acrylique pour éclairage général. Wallwasher pour un éclairage vertical homogène. Driver intégré dans le luminaire, au choix ON/OFF ou graduable (1-10V, DALI, Touch-Dim, Casambi). Température de couleur 2200K, 2700K, 3000K, 3500K, 4000K ou 6500K. Binning initial  $\leq$  MacAdam 3. Rendu de couleur CRI>80 ou CRI>90. Installation en encastré au choix avec cadre de montage, ou alternative avec kit de fixation/étriers. Cadre de montage en encastré ou profilé vide livrable et disponible en avance; montage possible des composants restants du luminaire, ultérieurement.

Installation Bracket without Shadow Gap

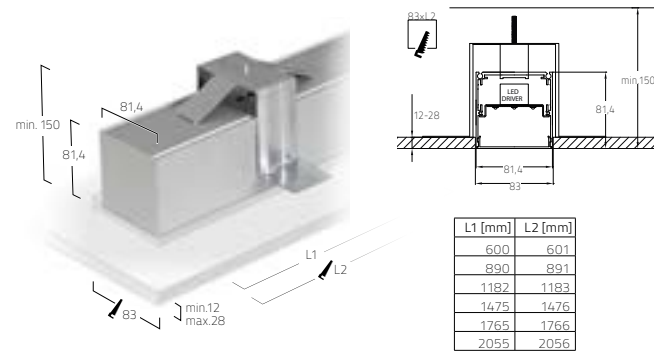

Installation Housing with Shadow Gap

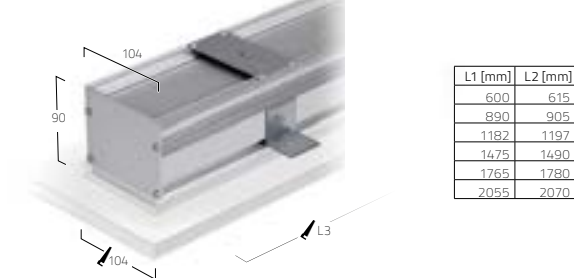

**PRODUCT-CODE:** LM5 O E E - 8 30 M - L890 - F

PRODUCT FAMILY - L: Matric

TYPE - M5: Recessed Direct Only

OPTICAL SYSTEM - O: Opal, A: Microprismatic, G: Wallwasher-1, J: Wallwasher-2, M: Satin Louver

SURFACE FINISH - E: Silver Anodised

CONTROL GEAR - E: On/Off, L: DALI, D: 1-10V, H: Touch-Dim, C: Casambi

COLOUR REND. - 8: CRI>80, 9: CRI>90, F: Full Spectrum

COLOUR TEMP. - 22: 2200K, 27: 2700K, 30: 3000K, 35: 3500K, 40: 4000K, 65: 6500K, TW: Tunable White 2700-6500K [L890-L2055]

POWER - E: Low Power, M: Medium Power, H: High Power

SIZE - Luminaire length in mm: L600, L890, L1182, L1475, L1765, L2055

INSTALLATION - F: Installation Housing, B: Installation Brackets

ON REQUEST - Special Length Versions, 90°-Corner, Midpin and Midpoint Spotlights/Downlights, Emergency Module, Multisensor



WALLWASHER 2

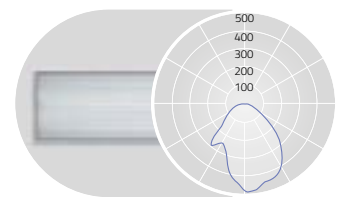

DIRECT: 100%

L mm	Lumen/Watt Medium Power	Lumen/Watt High Power
600	1550lm/14W	2050lm/19W
890	2320lm/21W	3080lm/29W
1182	3090lm/27W	4110lm/38W
1475	3860lm/33W	5130lm/46W
1765	4630lm/39W	6160lm/54W
2055	5410lm/45W	7180lm/61W

MICROPRISMATIC

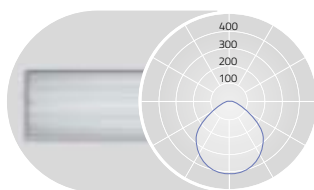

UGR<sub>s</sub> 19 for Low Power (X=4H, Y=8H, S=0.25H)  
DIRECT 100%

OPAL

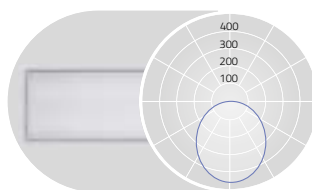

DIRECT 100%

SATIN LOUVER

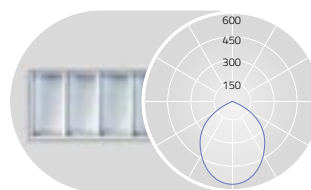

UGR<sub>s</sub> 19 for Medium Power (X=4H, Y=8H, S=0.25H)  
DIRECT 100%

WALLWASHER 1

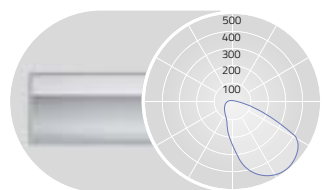

DIRECT 100%

L mm	Lumen/Watt Low Power	Lumen/Watt Medium Power	Lumen/Watt High Power
600	1080lm/10W	1650lm/14W	2190lm/19W
890	1620lm/14W	2470lm/21W	3280lm/29W
1182	2160lm/18W	3290lm/27W	4370lm/38W
1475	2710lm/22W	4110lm/33W	5470lm/46W
1765	3250lm/25W	4940lm/39W	6560lm/54W
2055	3790lm/29W	5760lm/45W	7650lm/61W

L mm	Lumen/Watt Low Power	Lumen/Watt Medium Power	Lumen/Watt High Power
600	1130lm/10W	1720lm/14W	2280lm/19W
890	1690lm/14W	2570lm/21W	3420lm/29W
1182	2260lm/18W	3430lm/27W	4560lm/38W
1475	2820lm/22W	4290lm/33W	5700lm/46W
1765	3390lm/25W	5150lm/39W	6840lm/54W
2055	3950lm/29W	6010lm/45W	7980lm/61W

L mm	Lumen/Watt Medium Power	Lumen/Watt High Power
600	1290lm/14W	1720lm/19W
890	1920lm/21W	2570lm/29W
1182	2550lm/27W	3430lm/38W
1475	3190lm/33W	4290lm/46W
1765	3820lm/39W	5150lm/54W
2055	4450lm/45W	6000lm/61W

L mm	Lumen/Watt High Power
600	1220lm/15W
890	1840lm/21W
1182	2450lm/27W
1475	3060lm/33W
1765	3670lm/39W
2055	4280lm/44W

Lumen Values: Luminaire luminous flux at 4000K/CRI>80. Other configurations on request.



# MATRIC 81 MM RECESSED FRAME | F5



					
90° CORNER OPAL / PRISMATIC	MIDPIN-DOWNLIGHT 770lm / 11W / Ø37mm	MIDPIN-SINGLE SPOTLIGHT 770lm / 11W / Ø37mm	MIDPOINT-SINGLE SPOTLIGHT Max. 3000lm/30W/ Ø90mm	MULTISENSOR DAYLIGHT & PRESENCE	
					
SNOW WHITE	SILVER ANODISED	URBAN GRAPHITE	JET BLACK	CHAMPAGNE SILVER	SATIN COPPER

**DE** LED-Einbauleuchte mit umlaufendem Rahmen für Montage in gesägten Deckenöffnungen. Rein direktstrahlend. Lichtkanal aus Aluminiumprofil mit 81mm Lichtspur-Breite. Millimetergenaue Längenfertigung nach Vorgabe möglich. Oberfläche naturelxiert oder weiß, graphit, schwarz, champagner oder kupferfarben lackiert. Weitere Oberflächenoptionen siehe Lightnet-Surface-Collection oder RAL nach Wahl. Microprismenoptik und Satin-Louvers für Office-Anwendungen. Opaldiffusor aus satiniertem Acrylglas für Allgemeinbeleuchtung. Wallwasher für homogene vertikale Beleuchtung. Driver integriert in Leuchtgehäuse integriert, wahlweise einfach schaltbar oder stufenlos dimmbar (1-10V, DALI, Touch-Dim, Casambi). Farbtemperaturen 2200K, 2700K, 3000K, 3500K, 4000K oder 6500K. Binning initial  $\leq$  MacAdam 3. Colour rendering CRI $>$ 80 oder CRI $>$ 90. Befestigungsset inklusive. Leuchtenprofil für Montage vorab lieferbar; restliche Leuchtenkomponenten zeitlich versetzt montierbar. Auf Anfrage: Integration von Notlichtkomponenten, Sensortechnologie sowie Vielzahl weiterer Optionen.

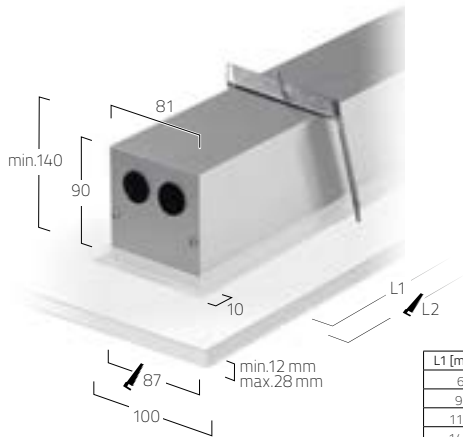

**EN** Recessed mounted LED luminaire with surrounding frame for installation in ceilings with cut-out openings. Direct only light distribution. Light channel made of aluminium profile with 81mm profile width. Precise length production according to specifications possible. Surface natural anodised or white, graphite, black, champagne or copper coated. Further surface options see Lightnet-Surface-Collection or RAL of your choice. Microprismatic screen and satin louver for office purposes. Opal diffuser made of acrylic glass for general lighting. Wallwasher for homogeneous vertical illuminance. Driver integrated into luminaire housing, optionally switchable or dimmable (1-10V, DALI, Touch-Dim, Casambi). Colour temperatures 2200K, 2700K, 3000K, 3500K, 4000K or 6500K. Binning initial  $\leq$  MacAdam 3. Colour rendering CRI $>$ 80 or CRI $>$ 90. Mounting brackets included. Luminaire profile available in advance for mounting; other luminaire components can be mounted later. On request: Integration of emergency lighting components, sensor technology as well as many other options.

**FR** Luminaire encastré LED avec cadre-colerette pour montage dans plafonds à découpe. Éclairage seulement direct. Rail lumineux en profilé d'aluminium avec une largeur d'éclairage de 81mm. Fabrication au millimètre près des longueurs selon les spécifications. Surface anodisée ou laquée blanc, graphite, noir, champagne ou cuivre. Autres options de finition voir Lightnet-Surface-Collection ou RAL au choix. Optique Microprismatique et satin louver pour postes de travail. Diffuseur opale en verre acrylique pour éclairage général. Wallwasher pour un éclairage vertical homogène. Driver intégré dans le luminaire, au choix ON/OFF ou graduable (1-10V, DALI, Touch-Dim, Casambi). Température de couleur 2200K, 2700K, 3000K, 3500K, 4000K ou 6500K. Binning initial  $\leq$  MacAdam 3. Rendu de couleur CRI $>$ 80 ou CRI $>$ 90. Cadre de montage et kit de fixations inclus. Cadre de montage en encastré ou profilé vide livrable et disponible en avance; montage possible des composants restants du luminaire, ultérieurement. Sur demande: Intégration de composants d'éclairage de secours ou de capteurs ainsi qu'une multitude d'autres options.

L1 [mm]	L2 [mm]
615	607
905	897
1198	1190
1490	1482
1780	1772
2075	2067

**PRODUCT-CODE:** **L F5 O E E - 8 30 M - L905**

PRODUCT FAMILY – L: Matric  
 TYPE – F5: Recessed Direct Only  
 OPTICAL SYSTEM – O: Opal, A: Microprismatic, G: Wallwasher-1, J: Wallwasher-2, M: Satin Louver  
 SURFACE FINISH – W: Snow White, E: Silver Anodised, U: Urban Graphite, B: Jet Black, H: Champagne Silver, K: Satin Copper  
 CONTROL GEAR – E: On/Off, L: DALI, D: 1-10V, H: Touch-Dim, C: Casambi  
 COLOUR REND. – 8: CRI $>$ 80, 9: CRI $>$ 90, F: Full Spectrum  
 COLOUR TEMP. – 22: 2200K, 27: 2700K, 30: 3000K, 35: 3500K, 40: 4000K, 65: 6500K, TW: Tunable White 2700-6500K [L905-L2075]  
 POWER – E: Low Power, M: Medium Power, H: High Power  
 SIZE – Luminaire length in mm: L615, L905, L1198, L1490, L1780, L2075  
 ON REQUEST – Special Length Versions, 90°-Corner, Midpin and Midpoint Spotlights/Downlights, Emergency Module, Multisensor

IP20 | | -220-240V | 50-60 Hz | IK 02 | RG0 EN62471 |  $\leq 3$  MacAdam | LOW POWER L90810 30000h | MEDIUM POWER L85810 50000h | HIGH POWER L80810 50000h |

WALLWASHER 2

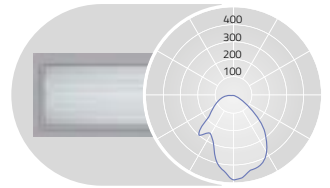

DIRECT: 100%

L mm	Lumen/Watt Medium Power	Lumen/Watt High Power
615	1550lm/14W	2050lm/19W
905	2320lm/21W	3080lm/29W
1198	3090lm/27W	4110lm/38W
1490	3860lm/33W	5130lm/46W
1780	4630lm/39W	6160lm/54W
2075	5410lm/45W	7180lm/61W

MICROPRISMATIC

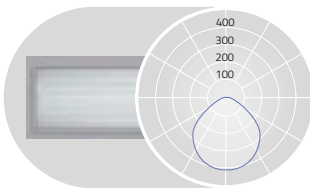

UGR $\leq$ 19 for Low Power (X=4H, Y=8H, S=0.25H)  
DIRECT 100%

L mm	Lumen/Watt Low Power	Lumen/Watt Medium Power	Lumen/Watt High Power
615	1080lm/10W	1650lm/14W	2190lm/19W
905	1620lm/14W	2470lm/21W	3280lm/29W
1198	2160lm/18W	3290lm/27W	4370lm/38W
1490	2710lm/22W	4110lm/33W	5470lm/46W
1780	3250lm/25W	4940lm/39W	6560lm/54W
2075	3790lm/29W	5760lm/45W	7650lm/61W

OPAL

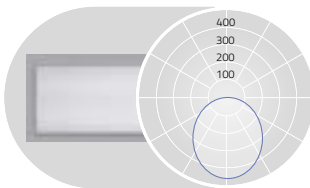

DIRECT 100%

L mm	Lumen/Watt Low Power	Lumen/Watt Medium Power	Lumen/Watt High Power
615	1130lm/10W	1720lm/14W	2280lm/19W
905	1690lm/14W	2570lm/21W	3420lm/29W
1198	2260lm/18W	3430lm/27W	4560lm/38W
1490	2820lm/22W	4290lm/33W	5700lm/46W
1780	3390lm/25W	5150lm/39W	6840lm/54W
2075	3950lm/29W	6010lm/45W	7980lm/61W

SATIN LOUVER

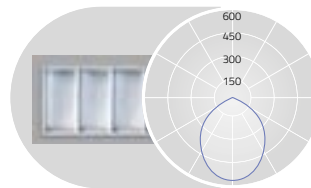

UGR $\leq$ 19 for Medium Power (X=4H, Y=8H, S=0.25H)  
DIRECT 100%

L mm	Lumen/Watt Medium Power	Lumen/Watt High Power
615	1290lm/14W	1720lm/19W
905	1920lm/21W	2570lm/29W
1198	2550lm/27W	3430lm/38W
1490	3190lm/33W	4290lm/46W
1780	3820lm/39W	5150lm/54W
2075	4450lm/45W	6000lm/61W

WALLWASHER-1

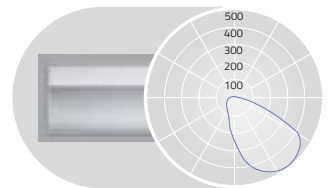

DIRECT 100%

L mm	Lumen/Watt High Power
615	1220lm/15W
905	1840lm/21W
1198	2450lm/27W
1490	3060lm/33W
1780	3670lm/39W
2075	4280lm/44W

Lumen Values: Luminaire luminous flux at 4000K/CRI $>$ 80. Other configurations on request.



BASIC MAX  
SURFACE IP54 | A1 500



MATRIC 38MM  
SURFACE IP54 | A1 504



MATRIC 55MM  
SURFACE IP54 | A3 506



MATRIC 38MM  
RECESSED FRAME IP54 | F1 508



MATRIC 55MM  
RECESSED FRAME IP54 | F3 510

 HÖHERE SCHUTZART | HIGHER PROTECTION | INDICE DE PROTECTION SUPÉRIEUR

BASIC MAX  
SURFACE IP54 | A1



**DE** LED-Anbauleuchte für Wand- oder Deckenmontage. Rein direktstrahlend. Leuchtenkörper aus Aluminiumprofil. Oberfläche weiß, silber, graphit, schwarz, champagner oder kupferfarben lackiert. Weitere Oberflächenoptionen siehe Lightnet-Surface-Collection oder RAL nach Wahl. Satinierter Opaldiffusor für Allgemeinbeleuchtung mit max. Transmissionsgrad und homogener Lichtpunktauflösung. Konverter in Leuchtengehäuse integriert, wahlweise einfach schaltbar oder stufenlos dimmbar (1-10V, DALI, Touch-Dim, Casambi). Farbtemperaturen 2200K, 2700K, 3000K, 3500K, 4000K oder 6500K. Binning initial  $\leq$  MacAdam 3. Farbwiedergabe CRI>80 oder CRI>90. Schutzart IP54. Auf Anfrage: Integration von Notlichtkomponenten.

**EN** LED surface-mounted luminaire for walls or ceilings. Direct only light distribution. Luminaire body made of aluminum profile. Surface white, silver, graphite, black, champagne or copper coated. Further surface options see Lightnet-Surface-Collection or RAL of your choice. Satin opal diffuser for general lighting with maximum transmittance and homogeneous lighting. Converter integrated into luminaire housing, optionally switchable or dimmable (1-10V, DALI, Touch-Dim, Casambi). Colour temperatures 2200K, 2700K, 3000K, 3500K, 4000K or 6500K. Binning initial  $\leq$  MacAdam 3. Colour rendering CRI>80 or CRI>90. Ingress protection IP54. On request: Integration of emergency lighting components.

**FR** Luminaire LED en saillie pour murs et plafonds. Éclairage seulement direct. Corps du luminaire en profilé aluminium. Surface laquée blanc, argent, graphite, noir, champagner ou cuivre. Autres options de finition voir Lightnet-Surface-Collection ou RAL au choix. Diffuseur opale satiné pour un éclairage général et une transmission maximale et homogène. Driver intégré dans le luminaire, au choix ON/OFF ou graduable (1-10V, DALI, Touch-Dim, Casambi). Température de couleur 2200K, 2700K, 3000K, 3500K, 4000K ou 6500K. Binning initial  $\leq$  MacAdam 3. Rendu de couleur CRI>80 ou CRI>90. Indice de protection IP54. Sur demande: Intégration de composants d'éclairage de secours

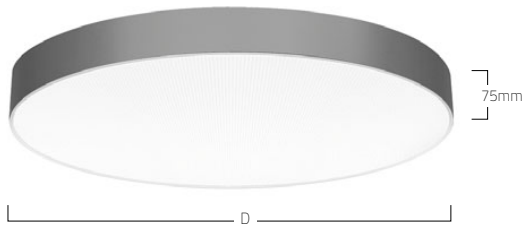

**PRODUCT-CODE:** B A1 O S D - 8 30 M - D300 - IP54

PRODUCT FAMILY	- B: Basic
TYPE	- A1: Direct Only
OPTICAL SYSTEM	- O: Opal
SURFACE FINISH	- W: Snow White, V: Ivory White, S: Radiant Silver, U: Urban Graphite, B: Jet Black, H: Champagne Silver, K: Satin Copper
CONTROL GEAR	- E: On/Off, L: DALI, D: 1-10V, H: Touch-Dim, C: Casambi
COLOUR REND.	- 8: CRI>80, 9: CRI>90, F: Full Spectrum
COLOUR TEMP.	- 22: 2200K, 27: 2700K, 30: 3000K, 35: 3500K, 40: 4000K, 65: 6500K
POWER	- E: Low Power, M: Medium Power
SIZE	- Luminaire Diameter in mm: D300, D400, D500, D600
PROTECTION	- IP54
ON REQUEST	- Emergency Module, Radar Sensor



OPAL DIFFUSER / DIRECT

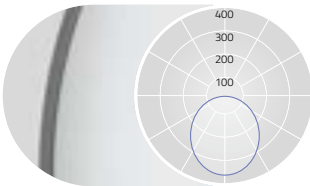

DIRECT: 100%

D mm	Lumen/Watt Low Power	Lumen/Watt Medium Power
300	910lm/8W	1780lm/14W
400	1790lm/13W	3690lm/29W
500	2550lm/18W	5010lm/35W
600	3980lm/28W	7470lm/52W

Lumen Values: Luminaire luminous flux at 4000K/CRI>80. Other configurations on request.



# MATRIC OUTDOOR





LENKWERKQUARTIER, BIELEFELD, GERMANY  
MATIC-A3-IP54



MATRIC 38 MM  
SURFACE IP54 | A1



**DE** LED-Anbauleuchte. Rein direktstrahlend. Lichtkanal aus Aluminiumprofil mit 38mm Lichtspur-Breite. Millimetergenaue Längenfertigung nach Vorgabe möglich. Oberfläche natureloxiert oder weiß, graphit, schwarz, champagner oder kupferfarben lackiert. Weitere Oberflächenoptionen siehe Lightnet-Surface-Collection oder RAL nach Wahl. Satinierter Opaldiffusor für Allgemeinbeleuchtung. Konverter in Leuchtgehäuse integriert, wahlweise einfach schaltbar oder stufenlos dimmbar (1-10V, DALI, Touch-Dim, Casambi). Farbtemperaturen 2200K, 2700K, 3000K, 3500K, 4000K oder 6500K. Binning initial  $\leq$  MacAdam 3. Farbwiedergabe CRI>80 oder CRI>90. Schutzart IP54. Auf Anfrage: Integration von Notlichtkomponenten.

**EN** LED surface-mounted luminaire. Direct only light distribution. Light channel made of aluminium profile with 38mm track width. Precise length production according to specifications possible. Surface natural anodised or white, graphite, black, champagne or copper coated. Further surface options see Lightnet-Surface-Collection or RAL of your choice. Satin opal diffuser for general lighting. Converter integrated into luminaire housing, optionally switchable or dimmable (1-10V, DALI, Touch-Dim, Casambi). Colour temperatures 2200K, 2700K, 3000K, 3500K, 4000K or 6500K. Binning initial  $\leq$  MacAdam 3. Colour rendering CRI>80 or CRI>90. Ingress protection IP54. On request: Integration of emergency lighting components.

**FR** Luminaire LED en saillie. Éclairage seulement direct. Rail lumineux en profilé d'aluminium avec une largeur d'éclairage de 38 mm. Fabrication au millimètre près des longueurs selon les spécifications. Surface anodisée ou laquée blanc, graphite, noir, champagne ou cuivre. Autres options de finition voir Lightnet-Surface-Collection ou RAL au choix. Diffuseur opale satinée pour un éclairage général. Driver intégré dans le luminaire, au choix ON/OFF ou graduable (1-10V, DALI, Touch-Dim, Casambi). Température de couleur 2200K, 2700K, 3000K, 3500K, 4000K ou 6500K. Binning initial  $\leq$  MacAdam 3. Rendu de couleur CRI>80 ou CRI>90. Indice de protection IP54. Sur demande: Intégration de composants d'éclairage de secours

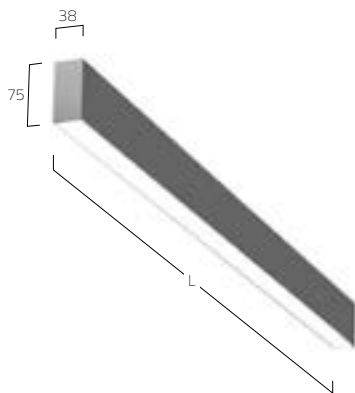

PRODUCT-CODE:	L A1 O E E - 8 30 M - L890 - IP54
PRODUCT FAMILY	- L: Matric
TYPE	- A1: Surface Direct Only
OPTICAL SYSTEM	- O: Opal
SURFACE FINISH	- E: Silver Anodised, W: Snow White, V: Ivory White, U: Urban Graphite, B: Jet Black, H: Champagne Silver, K: Satin Copper
CONTROL GEAR	- E: On/Off, L: DALI, D: 1-10V, H: Touch-Dim, A: Casambi Micro
COLOUR REND.	- 8: CRI>80, 9: CRI>90, F: Full Spectrum
COLOUR TEMP.	- 22: 2200K, 27: 2700K, 30: 3000K, 35: 3500K, 40: 4000K, 65: 6500K
POWER	- M: Medium Power
SIZE	- Luminaire length in mm: L600, L890, L1182, L1475, L1765, L2055
PROTECTION	- IP54
ON REQUEST	- Emergency Module

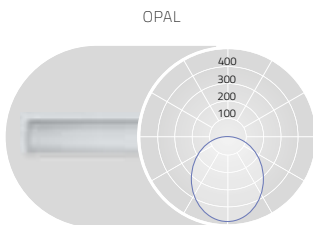

DIRECT 100%

L mm	Lumen/Watt Medium Power
600	900lm/9W
890	1350lm/13W
1182	1810lm/16W
1475	2260lm/20W
1765	2710lm/23W
2055	3160lm/26W

Lumen Values: Luminaire luminous flux at 4000K/CRI>80. Other configurations on request.

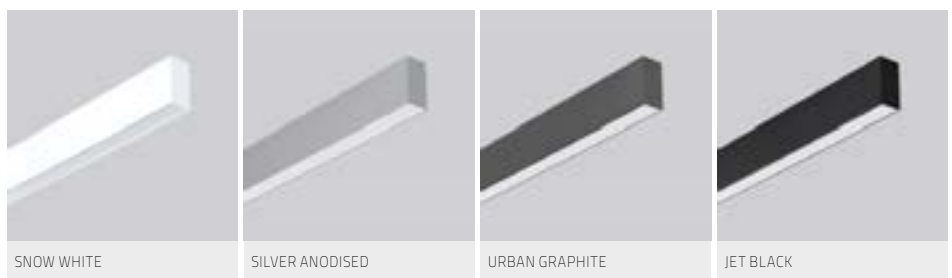

MATRIC 55 MM  
SURFACE IP54 | A3



**DE** LED-Anbauleuchte. Rein direktstrahlend. Lichtkanal aus Aluminiumprofil mit 55mm Lichtspur-Breite. Millimetergenaue Längenfertigung nach Vorgabe möglich. Oberfläche natureloxiert oder weiß, graphit, schwarz, champagner oder kupferfarben lackiert. Weitere Oberflächenoptionen siehe Lightnet-Surface-Collection oder RAL nach Wahl. Satinierter Opaldiffusor für Allgemeinbeleuchtung. Konverter in Leuchtengehäuse integriert, wahlweise einfach schaltbar oder stufenlos dimmbar (1-10V, DALI, Touch-Dim, Casambi). Farbtemperaturen 2200K, 2700K, 3000K, 3500K, 4000K oder 6500K. Binning initial ≤ MacAdam 3. Farbwiedergabe CRI>80 oder CRI>90. Auf Anfrage: Integration von Notlichtkomponenten. Schutzart IP54.

**EN** LED surface-mounted luminaire. Direct only light distribution. Light channel made of aluminium profile with 55mm track width. Precise length production according to specifications possible. Surface natural anodised or white, graphite, black, champagne or copper coated. Further surface options see Lightnet-Surface-Collection or RAL of your choice. Satin opal diffuser for general lighting. Converter integrated into luminaire housing, optionally switchable or dimmable (1-10V, DALI, Touch-Dim, Casambi). Colour temperatures 2200K, 2700K, 3000K, 3500K, 4000K or 6500K. Binning initial ≤ MacAdam 3. Colour rendering CRI>80 or CRI>90. On request: Integration of emergency lighting components. Ingress protection IP54.

**FR** Luminaire LED en saillie. Éclairage seulement direct. Rail lumineux en profilé d'aluminium avec une largeur d'éclairage de 55mm. Fabrication au millimètre près des longueurs selon les spécifications. Surface anodisée ou laquée blanc, graphite, noir, champagne ou cuivre. Autres options de finition voir Lightnet-Surface-Collection ou RAL au choix. Diffuseur opale satinée pour un éclairage général. Driver intégré dans le luminaire, au choix ON/OFF ou graduable (1-10V, DALI, Touch-Dim, Casambi). Température de couleur 2200K, 2700K, 3000K, 3500K, 4000K ou 6500K. Binning initial ≤ MacAdam 3. Rendu de couleur CRI>80 ou CRI>90. Sur demande: Intégration de composants d'éclairage de secours Indice de protection IP54.

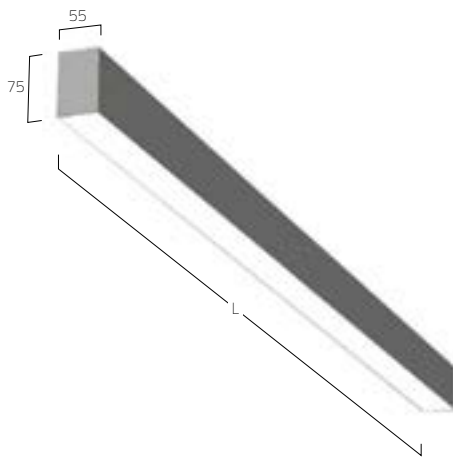

**PRODUCT-CODE:** L A3 O E E - 8 30 M - L890 - IP54

PRODUCT FAMILY	- L: Matric
TYPE	- A3: Surface Direct Only
OPTICAL SYSTEM	- O: Opal
SURFACE FINISH	- W: Snow White, V: Ivory White, E: Silver Anodised,
	U: Urban Graphite, B: Jet Black,
	H: Champagne Silver, K: Satin Copper
CONTROL GEAR	- E: On/Off, L: DALI, D: 1-10V, H: Touch-Dim, C: Casambi
COLOUR REND.	- 8: CRI>80, 9: CRI>90, F: Full Spectrum
COLOUR TEMP.	- 22: 2200K, 27: 2700K, 30: 3000K, 35: 3500K, 40: 4000K, 65: 6500K
POWER	- M: Medium Power
SIZE	- Luminaire length in mm: L600, L890, L1182, L1475, L1765, L2055
PROTECTION	- IP54
ON REQUEST	- Emergency Module



OPAL

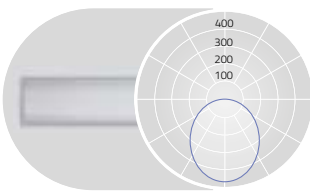

DIRECT 100%

L mm	Lumen/Watt Medium Power
600	1390lm/13W
890	2080lm/19W
1182	2770lm/24W
1475	3470lm/29W
1765	4160lm/34W
2055	4850lm/39W

Lumen Values: Luminaire luminous flux at 4000K/CRI>80. Other configurations on request.



MATRIC 38 mm  
RECESSED FRAME IP54 | F1



**DE** LED-Einbauleuchte mit umlaufendem Rahmen für Montage in gesägten Deckenöffnungen. Rein direktstrahlend. Lichtkanal aus Aluminiumprofil mit 38mm Lichtspur-Breite. Millimetergenaue Längenfertigung nach Vorgabe möglich. Oberfläche naturelxiert oder weiß, graphit, schwarz, champagner oder kupferfarben lackiert. Weitere Oberflächenoptionen siehe Lightnet-Surface-Collection oder RAL nach Wahl. Satinierter Opaldiffusor für Allgemeinbeleuchtung. Konverter in Leuchtgehäuse integriert, wahlweise einfach schaltbar oder stufenlos dimmbar (1-10V, DALI, Touch-Dim, Casambi). Farbtemperaturen 2200K, 2700K, 3000K, 3500K, 4000K oder 6500K. Binning initial ≤ MacAdam 3. Farbwiedergabe CRI>80 oder CRI>90. Befestigungsset inklusive. Leuchtenprofil für Montage vorab lieferbar; restliche Leuchtenkomponenten zeitlich versetzt montierbar. Auf Anfrage: Integration von Notlichtkomponenten. Schutzart IP54.

**EN** Recessed mounted LED luminaire with surrounding frame for installation in ceilings with cut-out openings. Direct only light distribution. Light channel made of aluminium profile with 38mm track width. Precise length production according to specifications possible. Surface natural anodised or white, graphite, black, champagne or copper coated. Further surface options see Lightnet-Surface-Collection or RAL of your choice. Satin opal diffuser for general lighting. Converter integrated into luminaire housing, optionally switchable or dimmable (1-10V, DALI, Touch-Dim, Casambi). Colour temperatures 2200K, 2700K, 3000K, 3500K, 4000K or 6500K. Binning initial ≤ MacAdam 3. Colour rendering CRI>80 or CRI>90. Mounting brackets included. Luminaire profile available in advance for mounting; other luminaire components can be mounted at different times. On request: Integration of emergency lighting components. Ingress protection IP54.

**FR** Luminaire encastré LED avec cadre-colerette pour montage dans plafonds à découpes. Éclairage seulement direct. Rail lumineux en profilé d'aluminium avec une largeur d'éclairage de 38 mm. Fabrication au millimètre près des longueurs selon les spécifications. Surface anodisée ou laquée blanc, graphite, noir, champagne ou cuivre. Autres options de finition voir Lightnet-Surface-Collection ou RAL au choix. Diffuseur opale satinée pour un éclairage général. Driver intégré dans le luminaire, au choix ON/OFF ou graduable (1-10V, DALI, Touch-Dim, Casambi). Température de couleur 2200K, 2700K, 3000K, 3500K, 4000K ou 6500K. Binning initial ≤ MacAdam 3. Rendu de couleur CRI>80 ou CRI>90. Cadre de montage et kit de fixations inclus. Cadre de montage en encastré ou profilé vide livrable et disponible en avance; montage possible des composants restants du luminaire, ultérieurement. Sur demande: Intégration de composants d'éclairage de secours Indice de protection IP54.

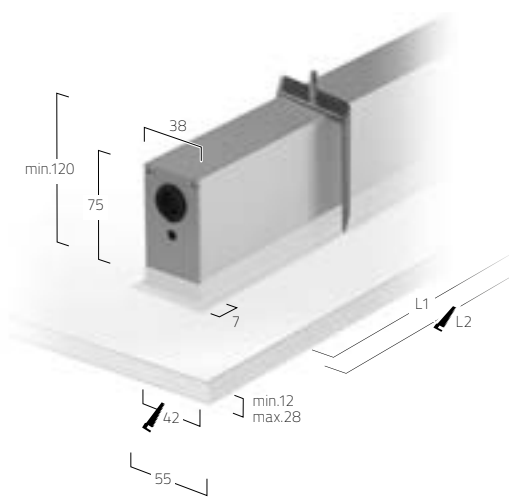

**PRODUCT-CODE:** L F1 O E E - 8 30 M - L900 - IP54

- PRODUCT FAMILY – L: Matric
- TYPE – F1: Recessed Direct Only
- OPTICAL SYSTEM – O: Opal
- SURFACE FINISH – W: Snow White, V: Ivory White, E: Silver Adodised, U: Urban Graphite, B: Jet Black, H: Champagne Silver, K: Satin Copper
- CONTROL GEAR – E: On/Off, L: DALI, D: 1-10V, H: Touch-Dim, A: Casambi Micro
- COLOUR REND. – 8: CRI>80, 9: CRI>90, F: Full Spectrum
- COLOUR TEMP. – 22: 2200K, 27: 2700K, 30: 3000K, 35: 3500K, 40: 4000K, 65: 6500K
- POWER – M: Medium Power
- SIZE – Luminaire length in mm: L610, L900, L1192, L1485, L1775, L2065
- PROTECTION – IP54
- ON REQUEST – Emergency Module

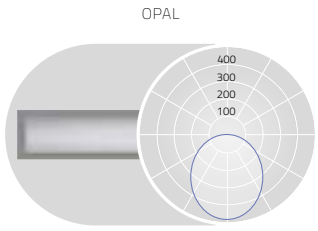

DIRECT 100%

L mm	Lumen/Watt Medium Power
610	900lm/9W
900	1350lm/13W
1192	1810lm/16W
1485	2260lm/20W
1775	2710lm/23W
2065	3160lm/26W

Lumen Values: Luminaire luminous flux at 4000K/CRI>80. Other configurations on request.



MATRIC 55<sub>MM</sub>  
RECESSED FRAME IP54 | F3



**DE** LED-Einbauleuchte mit umlaufendem Rahmen für Montage in gesägten Deckenöffnungen. Rein direktstrahlend. Lichtkanal aus Aluminiumprofil mit 55mm Lichtspur-Breite. Millimetergenaue Längenfertigung nach Vorgabe möglich. Oberfläche naturelxiert oder weiß, graphit, schwarz, champagner oder kupferfarben lackiert. Weitere Oberflächenoptionen siehe Lightnet-Surface-Collection oder RAL nach Wahl. Satinierter Opaldiffusor für Allgemeinbeleuchtung. Konverter in Leuchtengehäuse integriert, wahlweise einfach schaltbar oder stufenlos dimmbar (1-10V, DALI, Touch-Dim, Casambi). Farbtemperaturen 2200K, 2700K, 3000K, 3500K, 4000K oder 6500K. Binning initial ≤ MacAdam 3. Farbwiedergabe CRI>80 oder CRI>90. Befestigungsset inklusive. Leuchtenprofil für Montage vorab lieferbar; restliche Leuchtenkomponenten zeitlich versetzt montierbar. Auf Anfrage: Integration von Notlichtkomponenten. Schutzart IP54.

**EN** Recessed mounted LED luminaire with surrounding frame for installation in ceilings with cut-out openings. Direct only light distribution. Light channel made of aluminium profile with 55mm track width. Precise length production according to specifications possible. Surface natural anodised or white, graphite, black, champagne or copper coated. Further surface options see Lightnet-Surface-Collection or RAL of your choice. Satin opal diffuser for general lighting. Converter integrated into luminaire housing, optionally switchable or dimmable (1-10V, DALI, Touch-Dim, Casambi). Colour temperatures 2200K, 2700K, 3000K, 3500K, 4000K or 6500K. Binning initial ≤ MacAdam 3. Colour rendering CRI>80 or CRI>90. Mounting brackets included. Luminaire profile available in advance for mounting; other luminaire components can be mounted at different times. On request: Integration of emergency lighting components. Ingress protection IP54.

**FR** Luminaire encastré LED avec cadre-colerette pour montage dans plafonds à découpes. Éclairage seulement direct. Rail lumineux en profilé d'aluminium avec une largeur d'éclairage de 55mm. Fabrication au millimètre près des longueurs selon les spécifications. Surface anodisée ou laquée blanc, graphite, noir, champagne ou cuivre. Autres options de finition voir Lightnet-Surface-Collection ou RAL au choix. Diffuseur opale satinée pour un éclairage général. Driver intégré dans le luminaire, au choix ON/OFF ou graduable (1-10V, DALI, Touch-Dim, Casambi). Température de couleur 2200K, 2700K, 3000K, 3500K, 4000K ou 6500K. Binning initial ≤ MacAdam 3. Rendu de couleur CRI>80 ou CRI>90. Cadre de montage et kit de fixations inclus. Cadre de montage en encastré ou profilé vide livrable et disponible en avance; montage possible des composants restants du luminaire, ultérieurement. Sur demande: Intégration de composants d'éclairage de secours Indice de protection IP54.

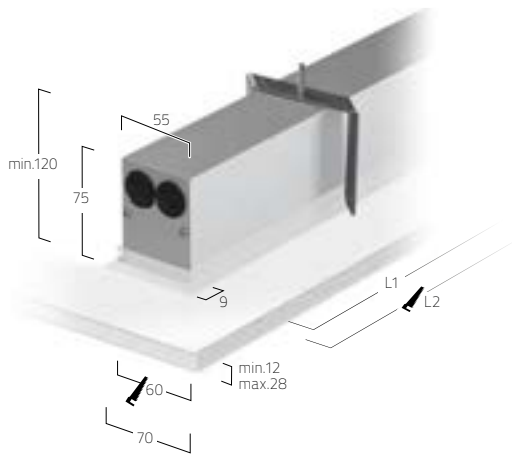

**PRODUCT-CODE:** L F3 O E E - 8 30 M - L905 - IP54

- PRODUCT FAMILY – L: Matrix
- TYPE – F3: Recessed Direct Only
- OPTICAL SYSTEM – O: Opal
- SURFACE FINISH – W: Snow White, V: Ivory White, E: Silver Anodised, U: Urban Graphite, B: Jet Black, H: Champagne Silver, K: Satin Copper
- CONTROL GEAR – E: On/Off, L: DALI, D: 1-10V, H: Touch-Dim, C: Casambi
- COLOUR REND. – 8: CRI>80, 9: CRI>90, F: Full Spectrum
- COLOUR TEMP. – 22: 2200K, 27: 2700K, 30: 3000K, 35: 3500K, 40: 4000K, 65: 6500K
- POWER – M: Medium Power
- SIZE – Luminaire length in mm: L615, L905, L1198, L1490, L1780, L2075
- PROTECTION – IP54
- ON REQUEST – Emergency Module

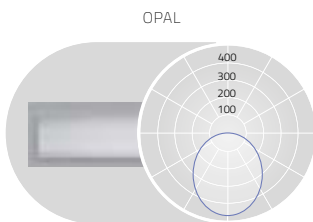

DIRECT 100%

L mm	Lumen/Watt Medium Power
615	1390lm/13W
905	2080lm/19W
1198	2770lm/24W
1490	3470lm/29W
1780	4160lm/34W
2075	4850lm/39W

Lumen Values: Luminaire luminous flux at 4000K/CRI>80. Other configurations on request.

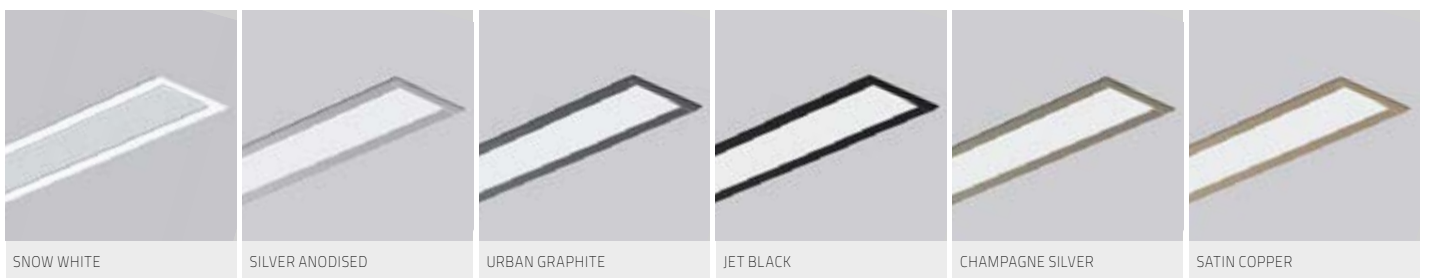





➤ APPENDIX

# MULTISENSOR

## General product description (short version)

### Option 1: Automatic mode

Luminaire turns itself on/off, automatic daylight and motion control

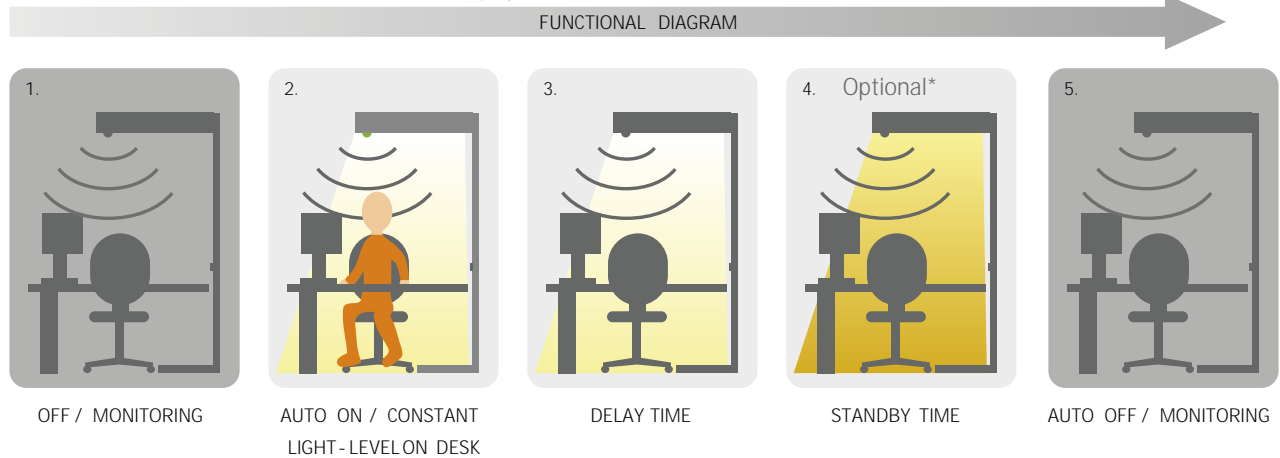

### Option 2: Semi-Automatic mode

Luminaire always switched on /off manually, automatic daylight and motion control

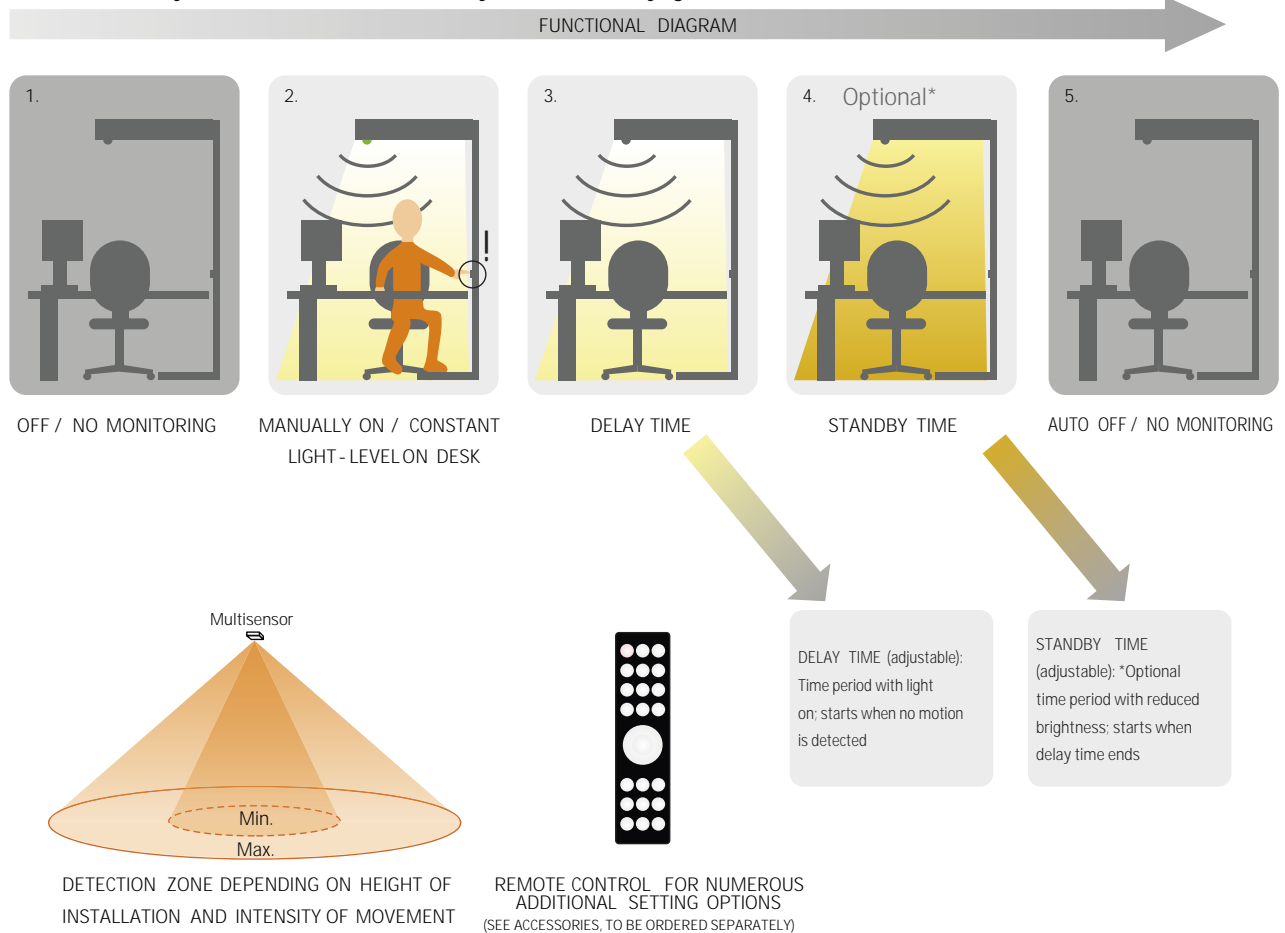

# RADAR SENSOR

## General product description (short version)

Luminaire turns on/off itself, automatic motion-detection

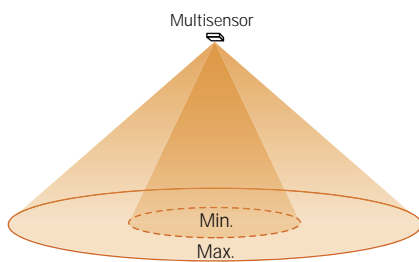
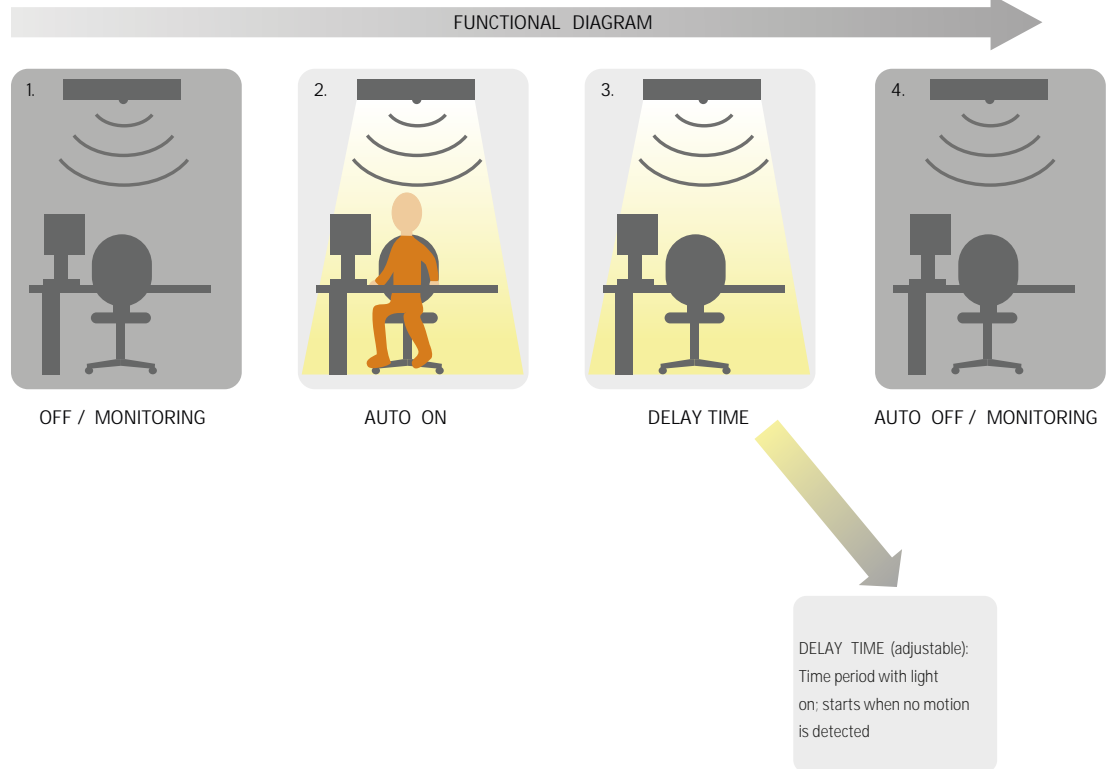

DETECTION ZONE DEPENDING ON HEIGHT OF INSTALLATION AND INTENSITY OF MOVEMENT

# SWARM SENSOR

## General product description (short version)

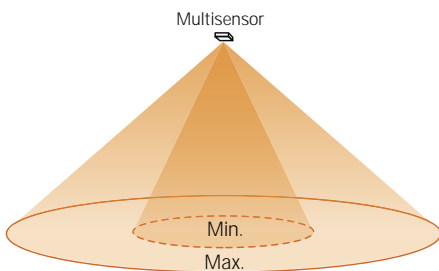
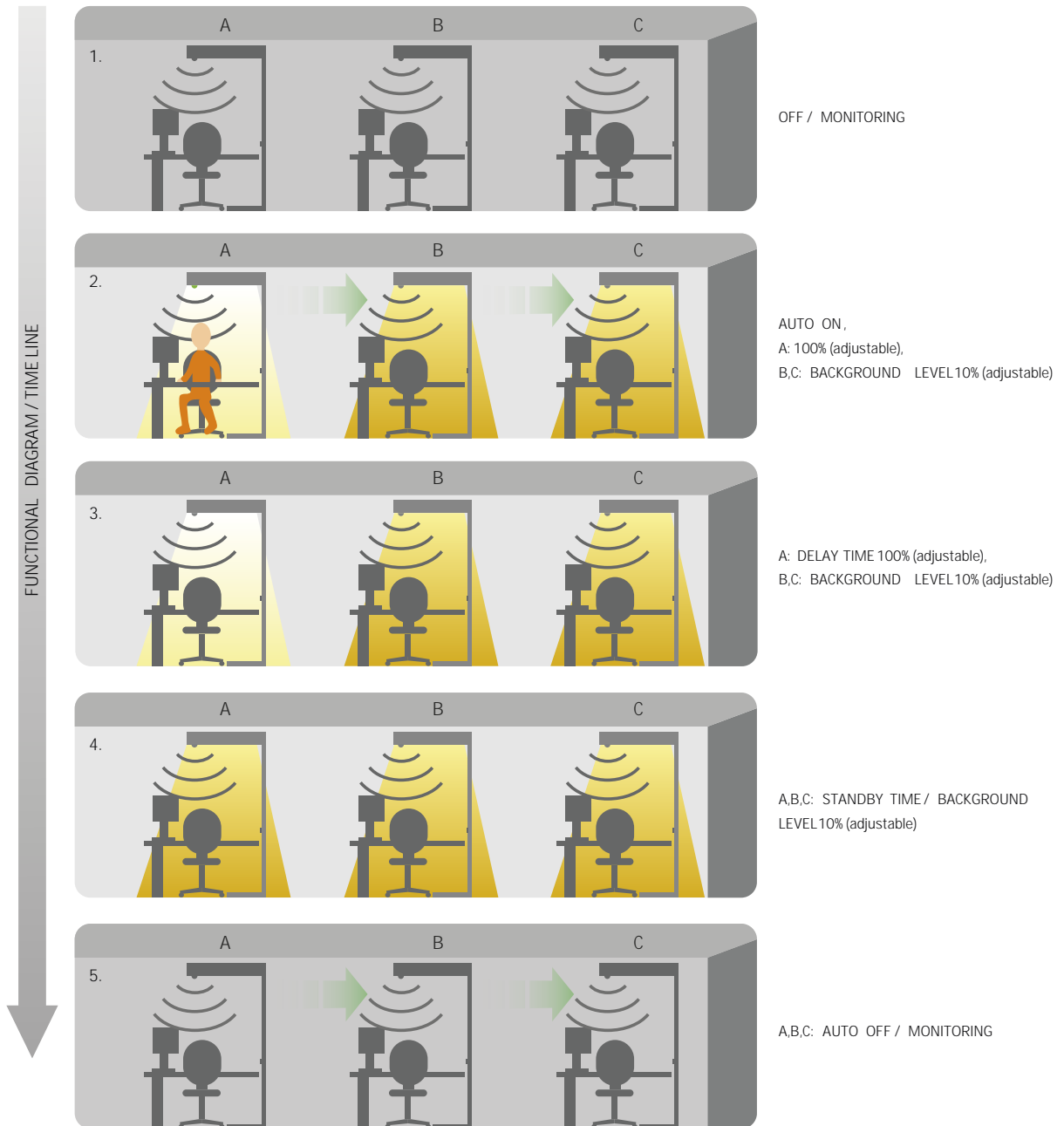

DETECTION ZONE DEPENDING ON HEIGHT OF INSTALLATION AND INTENSITY OF MOVEMENT



REMOTE CONTROL FOR NUMEROUS ADDITIONAL SETTING OPTIONS (SEE ACCESSORIES, TO BE ORDERED SEPARATELY)

# EMERGENCY LIGHT

General product description (short version)

Option 1: Built in battery pack

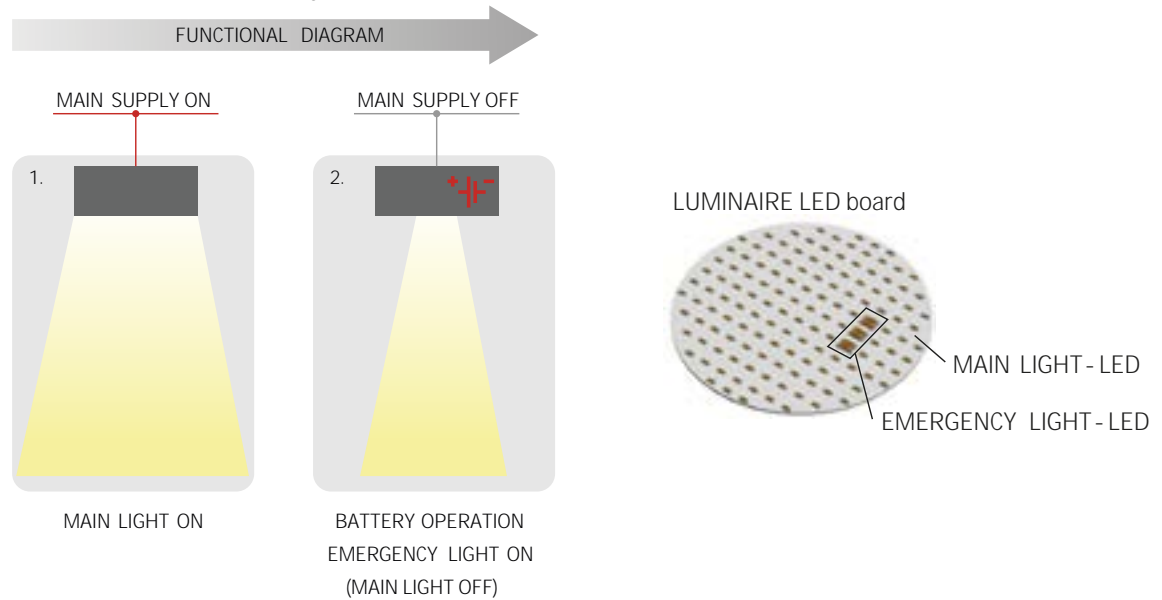

Option 2: External central battery

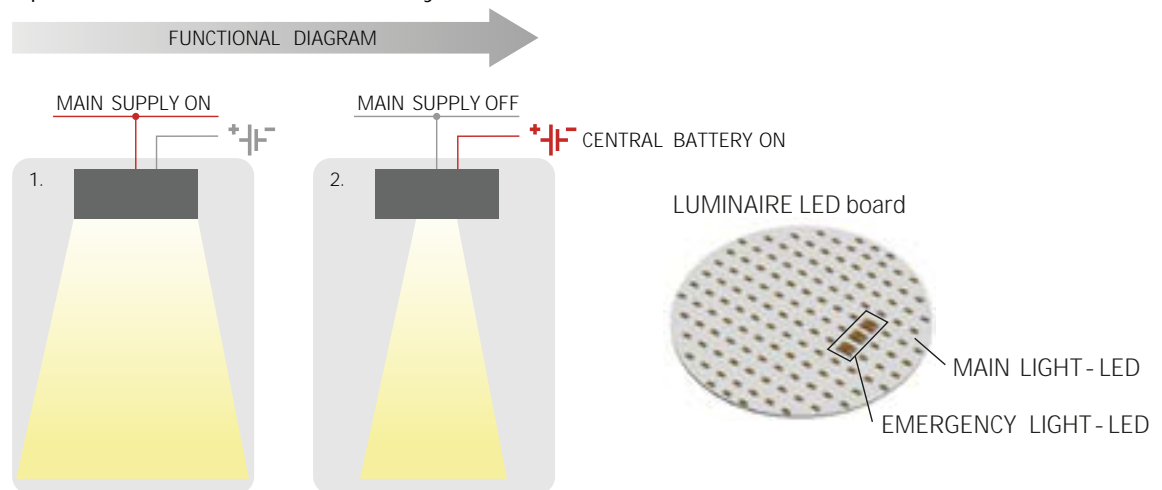

**Rechtliche Hinweise:**

- Alle Angaben in diesem Katalog entsprechen dem Stand bei Drucklegung. Sie dienen ausschließlich Informationszwecken und sind unverbindlich
- Lightnet behält sich das Recht vor, jederzeit und ohne vorherige Ankündigung Änderungen in Abmessung, Konstruktion, Gewicht, Lichtstrom, Leistungsaufnahme und Lichtverteilung vorzunehmen
- Lightnet passt seine Produkte laufend den neusten technischen Entwicklungen an, dies gilt sowohl für LED-Chips, Betriebsgeräte, Materialität der Produkte und Optiken, Oberflächen, Abmessungen etc.
- Einhergehende Änderungen der Lichtverteilung, Lichtströme, Leistungsaufnahme, Blendwirkung bzw. UGR-Werte etc. gegenüber Katalogwerten sind im Zeitablauf unvermeidbar. Zur Sicherstellung einer möglichst aktuellen technischen und lichttechnischen Beurteilung ziehen Sie daher bitte grundsätzlich die auf Homepage [www.lightnet.de](http://www.lightnet.de) zur Verfügung gestellten und laufend aktualisierten Datenblätter, lichttechnischen Dateien und sonstige erläuternde Informationen heran
- Gegenüber Abbildungen und/oder Photos kann es beim Produkt zu Abweichungen kommen, für die keine Haftung übernommen wird
- Es erfolgt keine Haftung für Druckfehler. Die nachträgliche Korrektur offensichtlicher Irrtümer wird vorbehalten
- Alle Aufträge werden ausschließlich zu den Allgemeinen Geschäfts- und Lieferbedingungen der Lightnet GmbH in gültiger Fassung entgegengenommen.
- Diese können jederzeit unter [www.lightnet.de](http://www.lightnet.de) eingesehen oder direkt bei Lightnet angefordert werden

**Technische Hinweise:**

- Alle Maßangaben werden in der Einheit Millimeter (mm) kommuniziert
- Alle Angaben zum Gewicht werden in der Einheit Kilogramm (kg) kommuniziert und unterliegen einer Toleranz von +/- 10%
- Alle Angaben zur Leistungsaufnahme werden in der Einheit Watt (W) kommuniziert und verstehen sich – soweit nicht explizit anders angegeben – inklusive integrierter Betriebsgeräte. Die kommunizierten Werte unterliegen initial einer Toleranz von +/- 10%
- Alle Angaben zur Farbtemperatur werden in der Einheit Kelvin (K) kommuniziert und unterliegen initial einer Toleranz von +/- 150K
- Alle Lichtstromangaben werden in der Einheit Lumen (lm) kommuniziert, unterliegen initial einer Toleranz von +/- 10% und bezeichnen die gesamte Lichtstromemission einer Leuchte
- Die angegebenen Lichtstromwerte beziehen sich auf eine Referenz-Messung mit Farbtemperatur ca. 4000K, Farbwiedergabeindex Ra>80, Leuchtgehäuse Farbe Weiß und Umgebungstemperatur 25 °C. Auf Anfrage stellt Lightnet die sich ergebenden Korrekturfaktoren für alternative Farbtemperatur, Farbwiedergabe sowie Gehäusefarbe zur Verfügung
- Lightnet arbeitet mit unterschiedlichen Lichteinspeisungen und LED-Chips für die Kategorien a) Strahler (MIDPOINT und MIDPIN), b) seitlich eingespeiste Leuchten (EVOLUTION, SUPERFLAT, NEO, DÉCO und JUNIOR) sowie c) hintergrundbeleuchtete Leuchten (alle übrigen Leuchten sowie DÉCO XXL). Wahrnehmbare Unterschiede der Leuchtdichte und/oder der Farbtemperatur sind bei Kombination vorstehender Kategorien technologisch bedingt und unvermeidbar
- Alle ausgezeichneten UGR-Werte beziehen sich auf das sogenannte UGR-Tabellen-Verfahren (Referenzraum 4H/8H gemäß LiTG; Reflexionsgrade D/W/B: 0,7/0,5/0,2; Abstands-/ Höhenverhältnis: 0,25)

**Allgemeine Hinweise:**

Wir weisen auf die einschlägigen Normen (z.B. DIN EN 12464-1) einer ordnungsgemäßen Beleuchtung für die jeweilige Anwendung hin. Die Ermittlung praxisnaher lichttechnischer Werte (Beleuchtungsstärke, Blendungsbegrenzung, Gleichmäßigkeit etc.) setzt das Erstellen einer Lichtplanung (z.B. anhand Software Dialux, Relux) unter Berücksichtigung der tatsächlichen Gegebenheiten vor Ort (Reflexionsgrade, Positionierung Leuchten und Mobiliar etc.) voraus.

Regelmäßig aktualisierte photometrische Dateien für die einzelnen Produkte stellt Lightnet unter [www.lightnet.de](http://www.lightnet.de) zur Verfügung.

**Legal notes:**

- All information in this catalogue is correct at the time of publication, is for information purposes only and does not constitute any obligation on our part
- Lightnet reserves the right to make changes in dimensions, construction, weight, luminous flux, power consumption and light distribution at any time and without prior notice
- Lightnet continuously adapts its products to the latest technical developments. This applies to LED chips, control gear, materiality of the products and optics, surfaces, product dimensions etc. Changes in light distribution, luminous flux, power consumption, glare or UGR values compared to catalogue values are unavoidable over time. To ensure that your technical and lighting assessment is up-to-date, please always refer to current data sheets, photometric files and other explanatory information made available on the homepage [www.lightnet.de](http://www.lightnet.de) and updated on an ongoing basis
- Compared to illustrations and/or photos, there may be deviations in the product for which no liability is assumed
- We shall not be held liable for printing errors. The correction of obvious errors is reserved
- All orders will be processed in accordance to the current version of our General Terms of Business and our Terms of Delivery.
- These can be viewed at any time at [www.lightnet.de](http://www.lightnet.de) or requested directly from Lightnet

**Technical information:**

- All dimensions are communicated in millimeters (mm)
- All weight information is communicated in kilograms (kg) and subject to a tolerance of +/- 10%
- All data on power consumption is communicated in watts (W) and – unless not stated otherwise – includes integrated control gear. All values are subject to a tolerance of max. +10%
- All information on the colour temperature are communicated in Kelvin (K) and are subject to a tolerance of +/- 150 K
- All data on luminous flux is communicated in lumen (lm), is subject to a tolerance of +/- 10% and indicates the delivered lumen output of a luminaire
- The communicated values refer to a reference measurement (colour temperature approx. 4000K, CRI > 80, colour of luminaire housing: white, environmental temperature: 25 °C). Upon request, Lightnet will provide the resulting correction values if the colour temperature, colour rendering (CRI) or luminaire housing colour changes
- Due to technological aspects Lightnet has to use different LED chips for the categories a) spotlights (MIDPOINT and MIDPIN), b) side-fed LED luminaires (EVOLUTION, SUPERFLAT, NEO, DÉCO and JUNIOR) and c) backlit LED luminaires (all other series and DÉCO XXL). Perceptible differences in luminance and/or colour temperature are technologically determined and unavoidable when the above mentioned categories are mixed
- All UGR marked products refer to the so-called UGR table method (reference space 4H / 8H according to LiTG, reflectance C / W / G: 0.7 / 0.5 / 0.2, distance/height ratio: 0.25)

**General information:**

We refer to the relevant standards (for example DIN EN 12464-1) for proper lighting in the relevant application. The determination of photometric values (illuminance, glare limitation, uniformity, etc.) according to given situation assumes the creation of a lighting design (for example, software Dialux, Relux) taking into account the real conditions on site (Reflectance, positioning of lights and furniture etc.). Regularly updated and current photometric files for each product are available at [www.lightnet.de](http://www.lightnet.de).

**Mentions légales:**

- Toutes les informations contenues dans ce catalogue sont correctes à la date de publication. Elles sont seulement pour information et ne constitue aucune obligation de notre part.
- Lightnet se réserve le droit de modifier les dimensions, la construction, le poids, le flux lumineux, la consommation énergétique et la distribution de la lumière à tout moment et sans préavis.
- Lightnet adapte continuellement ses produits aux derniers développements technologiques. Ceci s'applique aux puces LED, aux ballasts, à la matérialité des produits et de l'optique, aux surfaces, aux dimensions du produit, etc. Les changements de la distribution de la lumière, le flux lumineux, la consommation d'énergie, l'éblouissement ou les valeurs UGR par rapport aux valeurs du catalogue sont inévitables dans le temps Afin de vous assurer que votre évaluation technique est à jour, veuillez toujours consulter les fiches techniques, les fichiers photométriques et autres informations explicatives disponibles sur la page d'accueil [www.lightnet.de](http://www.lightnet.de) qui est actualisées de manière permanente.
- En rapport aux illustrations et/ou photos, il peut y avoir des divergences dans le produit pour lesquelles aucune responsabilité n'est assumée.
- Nous déclinons toute responsabilité en cas d'erreurs d'impression. La correction d'erreurs est réservée.
- Toutes les commandes sont traitées conformément à la version actuelle de nos conditions générales de vente et de livraison. Celles-ci peuvent être consultées à tout moment sur [www.lightnet.de](http://www.lightnet.de) ou demandées directement auprès de Lightnet.

**Informations techniques :**

- Toutes les dimensions sont communiquées en millimètres (mm).
- Toutes les informations relatives au poids sont communiquées en kilogrammes (kg) et sont soumises à une tolérance de +/- 10%.
- Toutes les informations relatives à la consommation énergétique sont communiquées en watts (W) et - sauf indication contraire - comprennent les équipements de contrôle. Toutes les données sont soumises à une tolérance de max. +10%.
- Toutes les informations sur la température de couleur sont communiquées en Kelvin (K) et sont soumises à une tolérance de +/- 150 K.
- Toutes les données sur le flux lumineux sont communiquées en lumen (lm) et sont soumises à une tolérance de +/- 10%. Elles indiquent la puissance lumineuse fournie par un luminaire.
- Les valeurs communiquées se réfèrent à une mesure de référence (température de couleur d'env. 4000K, CRI > 80, surface du luminaire: blanc, température ambiante: 25 °C). Sur demande, Lightnet fournit les facteurs de changement si la température de couleur, le rendu des couleurs (CRI) ou la couleur du luminaire change.
- En raison d'aspects technologiques, Lightnet doit utiliser des puces LED différentes pour les catégories a) projecteurs (MIDPOINT et MIDPIN), b) luminaires LED à fonctionnement latéral (EVOLUTION, SUPERFLAT, NEO, DÉCO et JUNIOR) et c) les luminaires retro-éclairés à LED (toutes les autres séries et DÉCO XXL). Les différences perceptibles de luminosité et/ou de température de couleur sont inévitables lorsque l'on combine les catégories ci-dessus.
- Tous les produits marqués UGR se réfèrent à la classification UGR (espace de référence 4H / 8H selon LiTG, réflectance C / W / G : 0,7 / 0,5 / 0,2, rapport distance / hauteur : 0,25).

**Informations générales :**

Nous nous référons aux normes en vigueur (par exemple DIN EN 12464-1) pour un éclairage adapté à l'application concernée. La détermination des valeurs photométriques (éclairage, limitation de l'éblouissement, uniformité, etc.) concrètes nécessite l'élaboration d'un plan d'éclairage (par exemple: les logiciels Dialux, Relux) tenant compte des conditions réelles sur site (Réflexion, positionnement des lumières et des meubles, etc.). Des fichiers photométriques régulièrement mis à jour pour chaque produit sont disponibles sur le site [www.lightnet.de](http://www.lightnet.de).

# SEARCH BY PRODUCT FAMILIES

<b>AMORPHICON</b>		PAGE	<b>LUCILLE</b>		PAGE
HG HP	AMORPHICON SUSPENDED	244 ff.	UT	LUCILLE TABLE	50 ff.
<b>BASIC</b>			UW	LUCILLE WALL	108 ff.
BC	BASIC 3-PHASE TRACK	38 ff.	<b>MATRIC</b>		
BF	BASIC FLOOR	70 ff.	LC	MATRIC 3-PHASE TRACK	42 ff.
BA BW	BASIC WALL	114 ff.	LT	MATRIC LENS LOUVER TABLE	56 ff.
BG BP	BASIC SUSPENDED	158 ff.	LF	MATRIC LENS LOUVER FLOOR	102 ff.
BY BX BA BZ	BASIC SURFACE	334 ff.	LW LD LJ	MATRIC WALL	136 ff.
BL BN BM	BASIC RECESSED	432 ff.	LG LR LP	MATRIC SUSPENDED	280 ff.
BA	BASIC SURFACE IP54	500 ff.	LA	MATRIC SURFACE	394 ff.
<b>BEAM ME UP</b>			LM LF LL	MATRIC RECESSED	482 ff.
MF	BEAM ME UP JR. FLOOR	78 ff.	LA	MATRIC SURFACE IP54	504 ff.
MG MP	BEAM ME UP SUSPENDED	170 ff.	LF	MATRIC RECESSED IP54	508 ff.
MY MX MA	BEAM ME UP SURFACE	350 ff.	<b>MIDPIN</b>		
<b>CALEO</b>			DC	MIDPIN MAGNETIC TRACK	28 ff.
AW	CALEO WALL	122 ff.	DM	MIDPIN RECESSED	416 ff.
AG AP AR	CALEO SUSPENDED	252 ff.	<b>MIDPOINT</b>		
AA AY AX	CALEO SURFACE	123 ff.	PC	MIDPOINT 3-PHASE TRACK	34 ff.
AL AM	CALEO RECESSED	153 ff.	PP	MIDPOINT SUSPENDED	150 ff.
<b>CUBIC</b>			PB PA	MIDPOINT SURFACE	326 ff.
CC	CUBIC 3-PHASE TRACK	40 ff.	PE PF PM	MIDPOINT RECESSED	418 ff.
CT	CUBIC TABLE	54	PK PQ PD		
CF	CUBIC FLOOR	86 ff.	<b>RINGO STAR</b>		
CW CJ CY CX CA	CUBIC WALL	128 ff.	RG RP	RINGO STAR + MIDPOINT SUSPENDED	152 ff.
CG CP CU CR	CUBIC SUSPENDED	262 ff.	RG RP	RINGO STAR SUSPENDED	194 ff.
CY CX CA	CUBIC SURFACE	382 ff.	RA	RINGO STAR SURFACE	360 ff.
CN CM	CUBIC RECESSED	464 ff.	RF	RINGO STAR RECESSED	448 ff.
<b>CODE ZERO</b>			<b>THREE PEAKS</b>		
ZG ZP	CODE ZERO SUSPENDED	244 ff.	YG YP	THREE PEAKS SUSPENDED	248 ff.
<b>LIQUID LINE</b>			YA	THREE PEAKS SURFACE	370 ff.
QG QP	LIQUID LINE SUSPENDED	224 ff.	<b>VISION</b>		
QA	LIQUID LINE SURFACE	366 ff.	VG VP	VISION SUSPENDED	320 ff.
QF	LIQUID LINE RECESSED	458 ff.	VA	VISION SURFACE	412 ff.





A r c h i t e c t u r a l   L i g h t i n g

LIGHTNET GMBH | ZOLLSTOCKGÜRTEL 63 | 50969 KÖLN

+49 (0) 221 22 25 26-0 | info@lightnet.de

[lightnet.de](http://lightnet.de)