

LEC

Lyon

LED EXPERTISE SINCE 1977

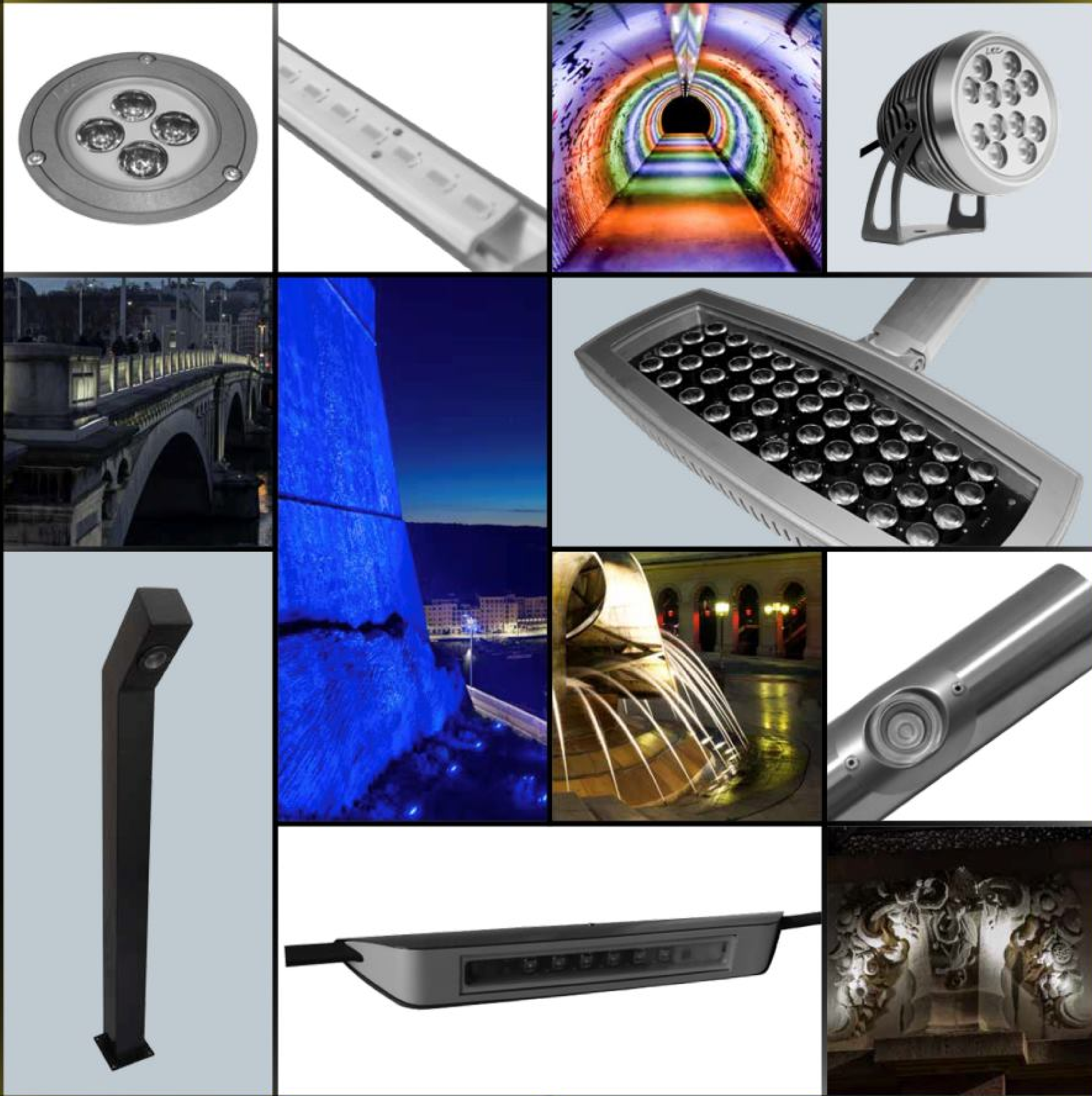



























40¹⁹⁷⁷/₂₀₁₇

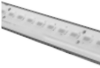

2017
PRODUITS
PRODUCTS

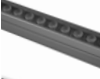
www.lec.fr

FAMILLES / FAMILIES

	Albi 5712.....	p. 70
	Alicante 5727.....	p. 72-73
	Allevard 5716.....	p. 71
	Alley 6450.....	p. 80
	Alma 1406.....	p. 11
	Angouleme 1832.....	p. 26
	Arches 5633.....	p. 62
	Belval 5630.....	p. 60-61
	Bordeaux 1530.....	p. 12-13
	Boulogne 6406.....	p. 78
	Bourgogne 1750.....	p. 16-18
	Brive 6060.....	p. 76
	Brunei 5620.....	p. 54-57
	Button A 5642.....	p. 67
	Button B 5643.....	p. 67
	Chateauneuf 1570.....	p. 14-15
	Clem 5650.....	p. 68
	Corsica 4660.....	p. 50-51
	Epernon 6190.....	p. 77
	Havre 4240.....	p. 47
	Leman 1806.....	p. 19
	Libourne 5624.....	p. 58
	Lignon 5655.....	p. 69
	Ligny 5635.....	p. 64
	Lima 5636.....	p. 65
	Linealec 5625.....	p. 59
	Lioran 1826.....	p. 22-23
	Lucerne 1830.....	p. 24-25

	Lugano 1950.....	p. 31
	LumiKub 2 4420, LumiKub 4 4440, LumiKub 5 4450.....	p. 49
	Luminy 4010.....	p. 40
	Luminy 2 4020.....	p. 41
	Luminy 4 4040.....	p. 42-43
	Luminy 6 4060.....	P. 44-45
	Luxembourg 2853.....	p. 34-35
	Matosinhos 0320.....	p. 9
	Meteor 2855.....	p. 36-37
	Palais Royal 1843.....	p. 28-29
	Parc 6430.....	p. 79
	Passy 5760.....	p. 75
	Philae 2858.....	p. 38-39
	Pyramide 2852.....	p. 32-33
	Rondo13 1402.....	p. 10
	Saint-Jean 4330.....	p. 48
	Saint Raphael 1844.....	p. 30
	Sandvika 1820.....	p. 21
	Savoie 1810.....	p. 20
	School-light 5640.....	p. 66
	Soulayr 5533.....	p. 53
	Stone 10 5432.....	p. 52
	Stripe 5634.....	p. 63
	Swindon 5733.....	p. 72
	Ville de Paris 1836.....	p. 27
	Vulcano 4130.....	p. 46



5620 BRUNEI p. 54-57



5630 BELVAL p. 60-61



5640 SCHOOL-LIGHT p. 66



5655 LIGNON p. 69



5642 BUTTON A p. 67

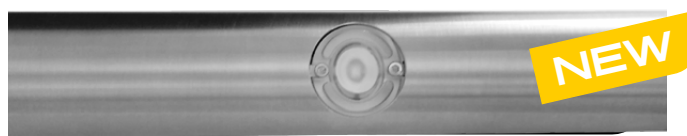

5643 BUTTON B p. 67



5533 SOULARY p. 53



1806 LEMAN p. 19



1810 SAVOIE p. 20



1820 SANDVIKA p. 21



1826 LIORAN p. 22-23



4010 LUMINY p. 40



1402 RONDO13 p. 10



1406 ALMA p. 11



4020 LUMINY 2 p. 41



4130 VULCANO p. 46



4240 HAVRE p. 47



4040 LUMINY 4 p. 42-43



4420 LUMIKUB 2 p. 49



4440 LUMIKUB 4 p. 49



4450 LUMIKUB 5 p. 49



4060 LUMINY 6 p. 44-45



4660 CORSICA p. 50-51



5630 BELVAL p. 60-61



5633 ARCHES p. 62



5634 STRIPE p. 63



5624 LIBOURNE p. 58



5625 LINEALEC p. 59



5635 LIGNY p. 64



5636 LIMA p. 65

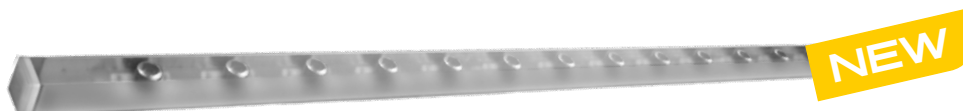

5650 CLEM p. 68



5655 LIGNON p. 69



1402 RONDO13 p. 10



1406 ALMA p. 11



1843 PALAIS ROYAL p. 28-29



1806 LEMAN p. 19



1844 SAINT RAPHAEL p. 30



1832 ANGOULEME p. 26



1836 VILLE DE PARIS p. 27



1750 BOURGOGNE
p. 16-18



1830 LUCERNE
p. 24-25



1950 LUGANO
p. 31



5712 ALBI
p. 70



5716 ALLEVARD p. 71



5727 ALICANTE p. 72-73



2855 METEOR p. 36-37



2858 PHILAE p. 38-39



2852 PYRAMIDE p. 32-33



2853 LUXEMBOURG p. 34-35



5432 STONE 10 p. 52



5620 BRUNEI p. 54-57



5733 SWINDON p. 74



5760 PASSY p. 75



0320 MATOSINHOS p. 9

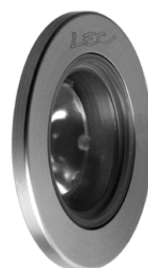

1530 BORDEAUX p. 12-13



1570 CHATEAUNEUF p. 14-15



4330 SAINT JEAN p. 48



5620 BRUNEI p. 54-57



5630 BELVAL p. 60-61



5733 SWINDON p. 74



0320 MATOSINHOS p. 9



1530X BORDEAUX p. 12-13



1570X CHATEAUNEUF p. 14-15



1750X BOURGOGNE p. 16-18



4022X LUMINY 2 p. 41



4042X LUMINY 4 p. 42-43

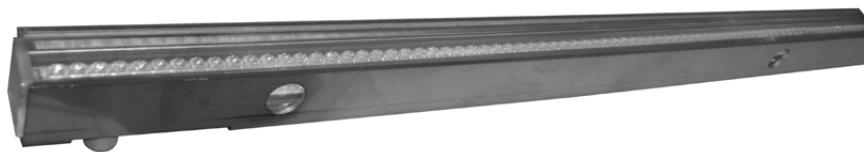

5620X BRUNEI p. 54-57



0320 MATOSINHOS p. 9



1530 BORDEAUX p. 12-13



1826 LIORAN p. 22-23



4010 LUMINY p. 40



6060 BRIVE p. 76



6190 EPERNON p. 77



4020 LUMINY 2 p. 41



4040 LUMINY 4 p. 42-43



5620 BRUNEI p. 54-57



5624 LIBOURNE p. 58

NEW



4060 LUMINY 6 p. 44-45



6406 BOULOGNE p. 78



6430 PARC p. 79



6450 ALLEY p. 80

NEW

0320

Matosinhos



0320L

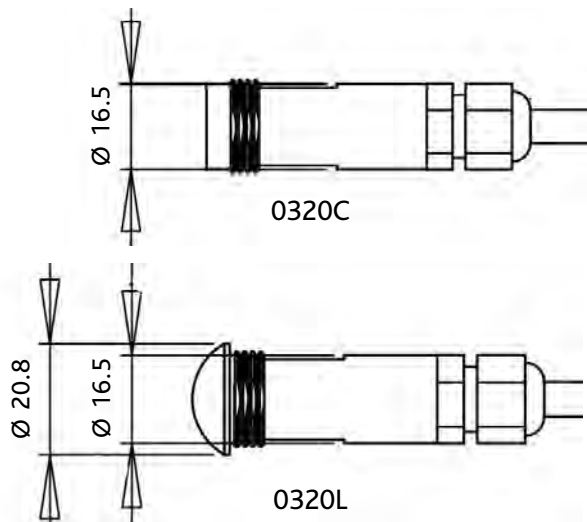

1

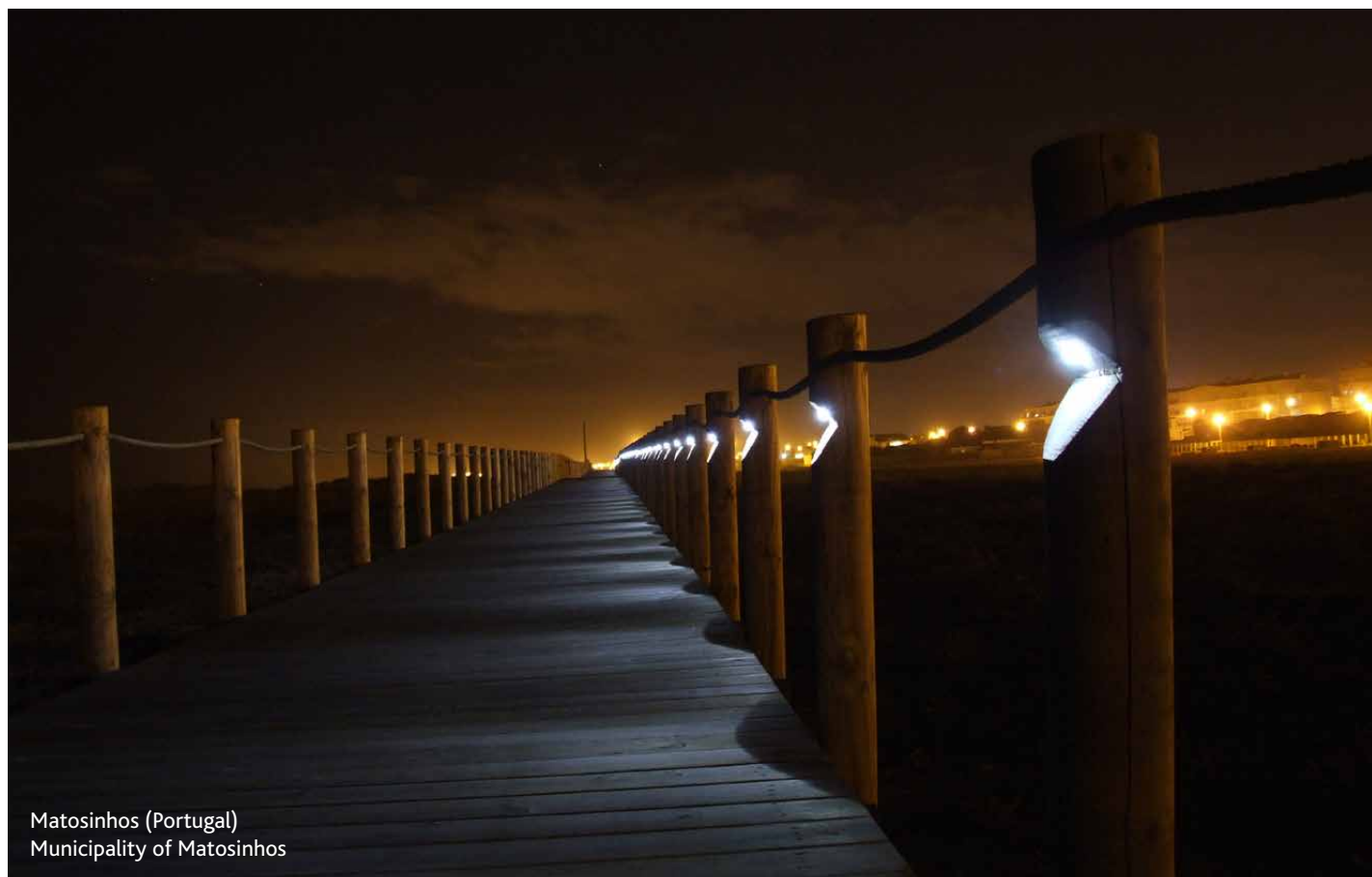
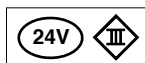
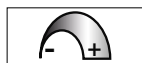

Matosinhos (Portugal)
Municipality of Matosinhos

1402

Rondo13

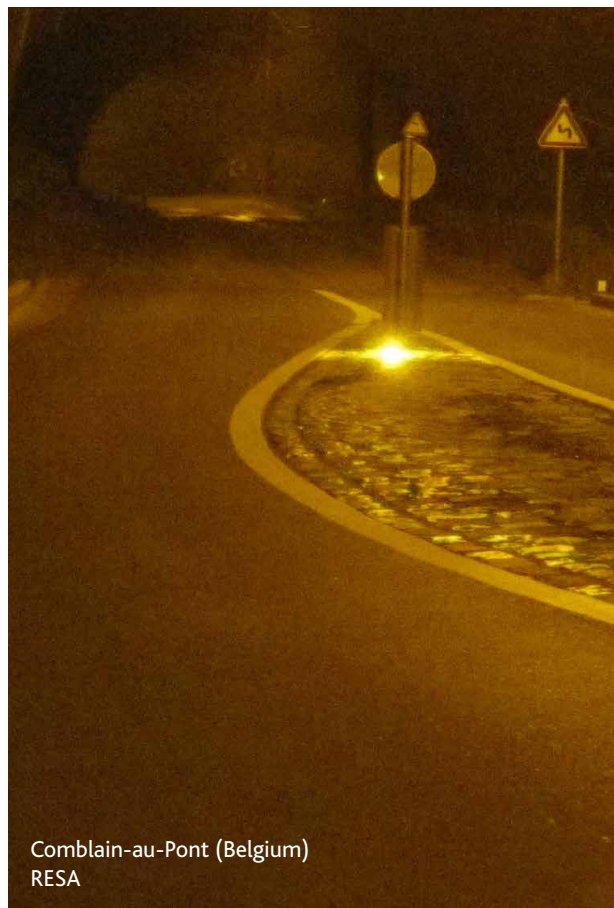
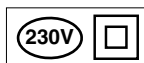
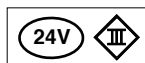
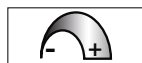
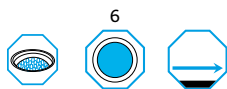
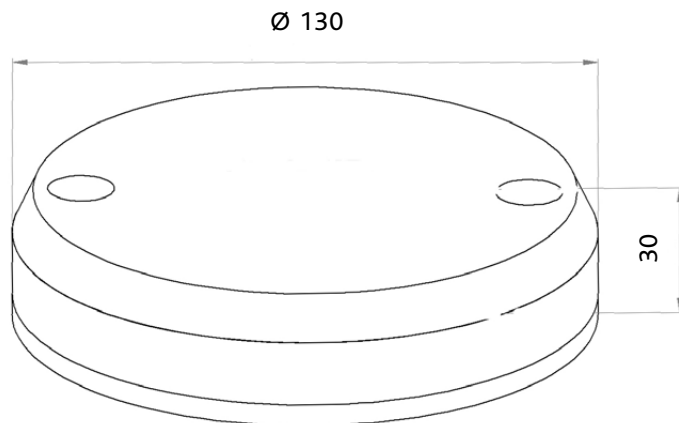

Comblain-au-Pont (Belgium)
RESA

1406

Alma

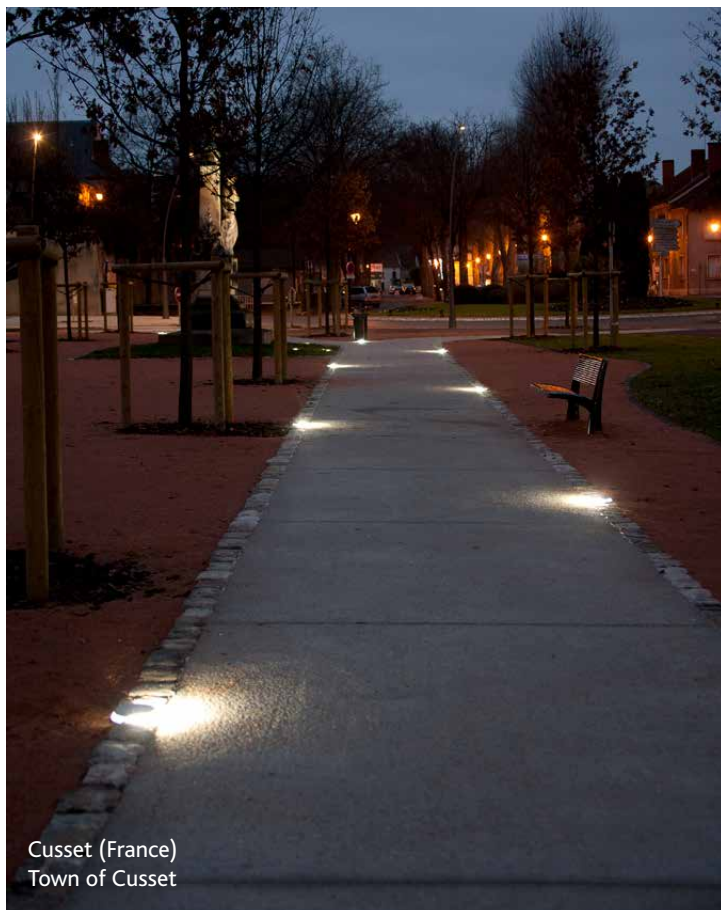
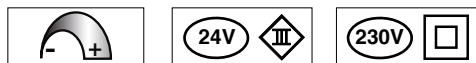
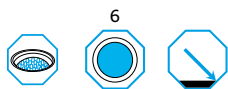
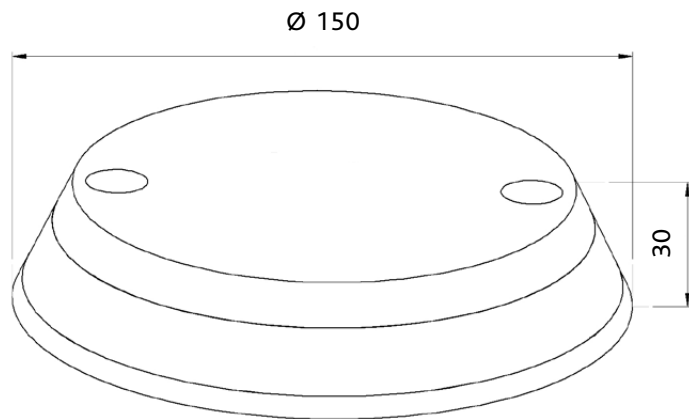

Cusset (France)
Town of Cusset

1530 Bordeaux



1530R

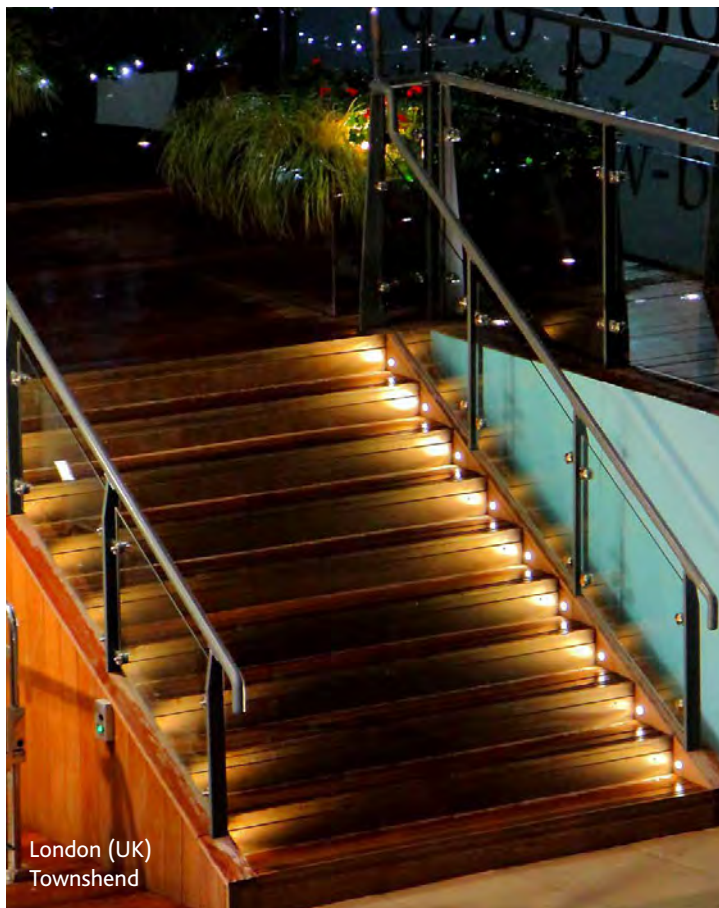
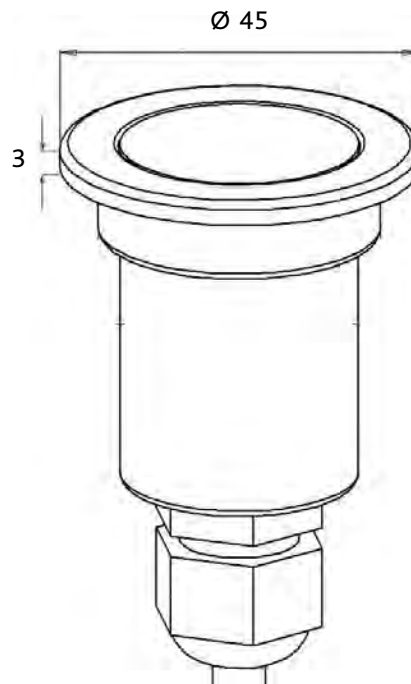

London (UK)
Townshend



1530 Bordeaux

1530R

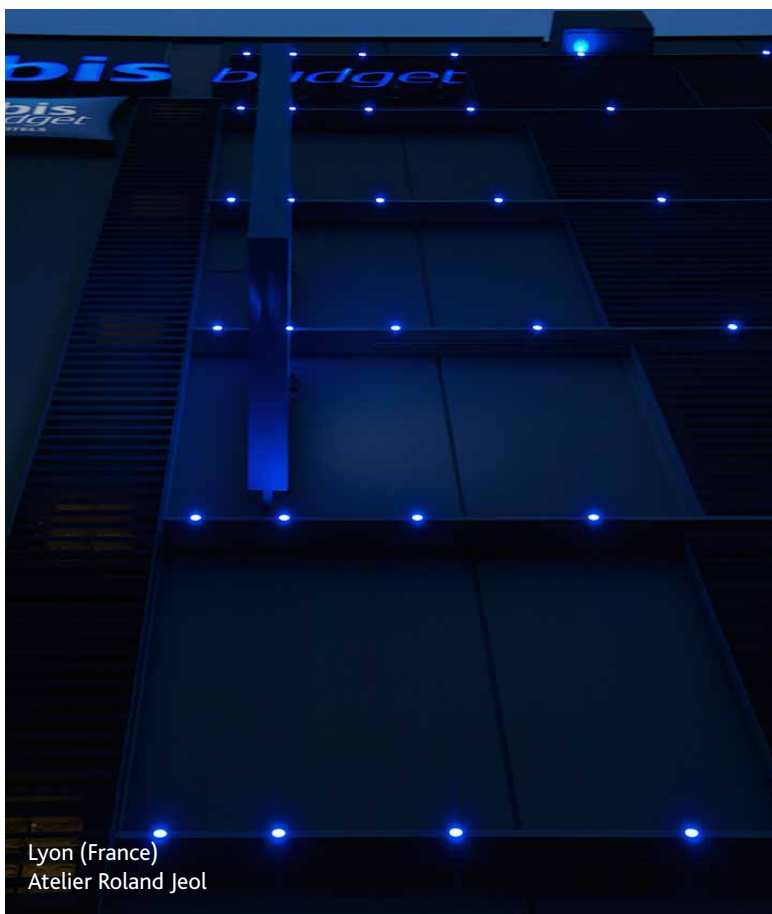
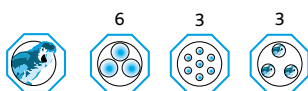

Lyon (France)
Atelier Roland Jeol

1530 Bordeaux

1530R-PH



**IK10
20 J**



1570 Chateauneuf

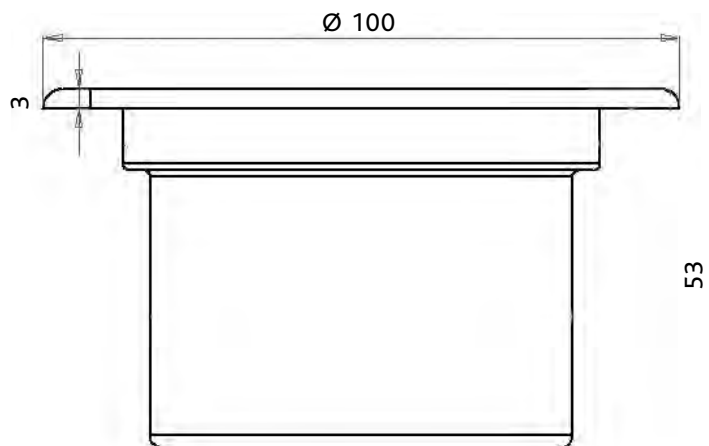

1570R

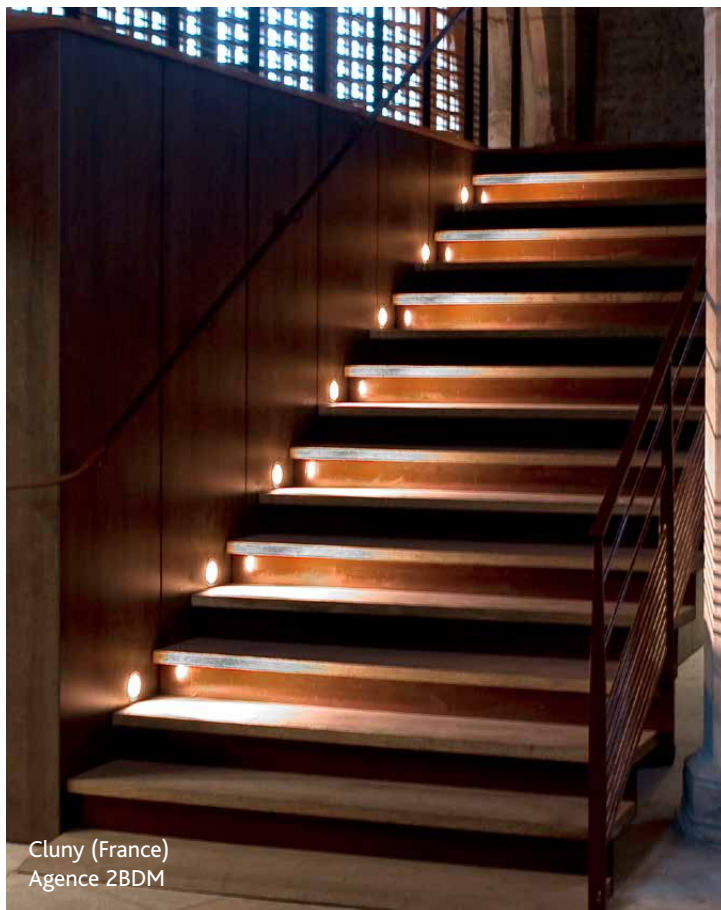

Cluny (France)
Agence 2BDM



1570 Chateauneuf

1570R

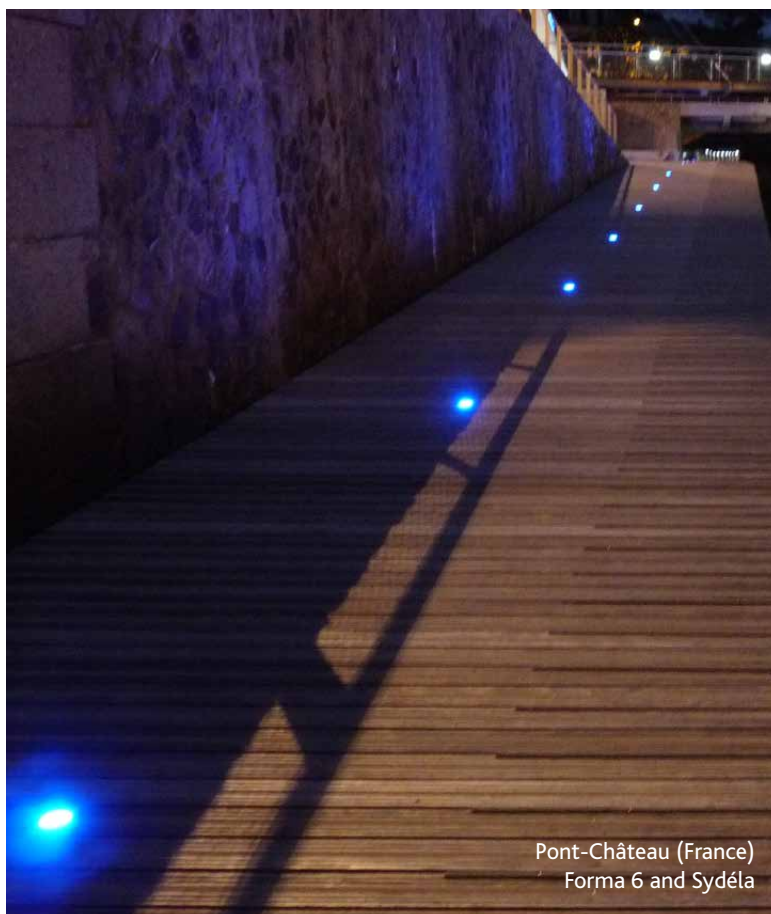

Pont-Château (France)
Forma 6 and Sydéla

1570 Chateauneuf

1570RM

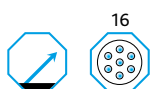

1750 Bourgogne



Ø 50



Ø 50



1750K

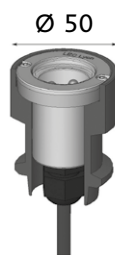

1750+E065



1750+E120

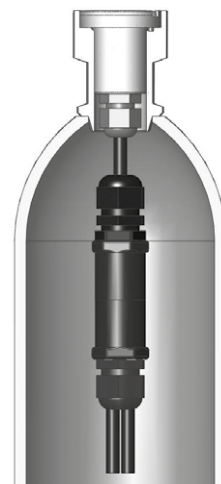

1750+E250

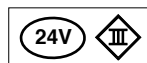
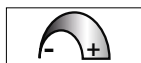

C1, C2, D, K, PH

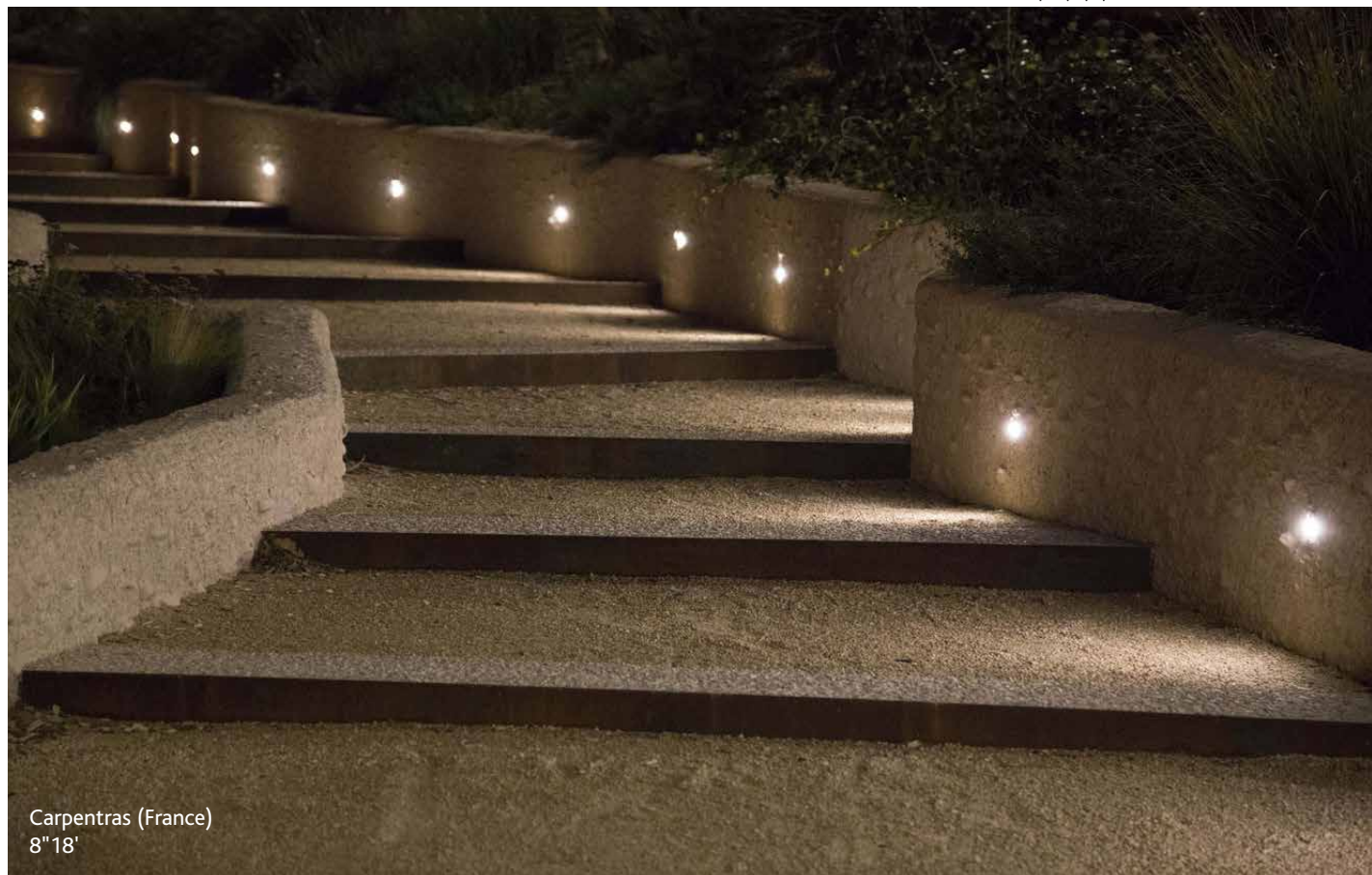

Carpentras (France)
8"18'



1750 Bourgogne

1750



1750K

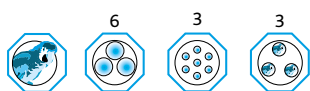

Lyon (France)
City of Lyon

1750 Bourgogne

1750-PH

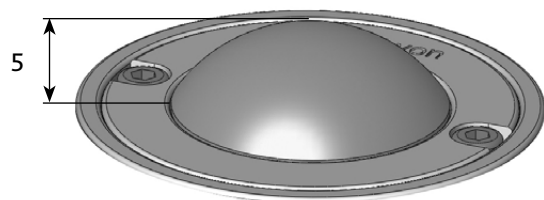



1750 Bourgogne

1750C1



Marseille (France)
Agence Lumière

1750A Bourgogne

1750C2



1806

Leman

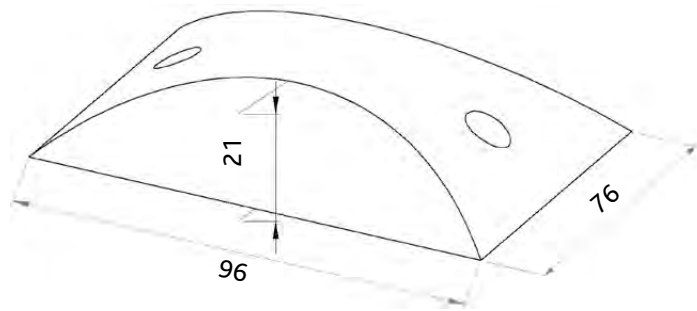

6, 12

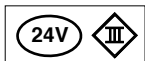
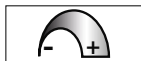

1810

Savoie

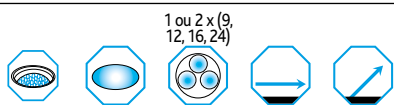
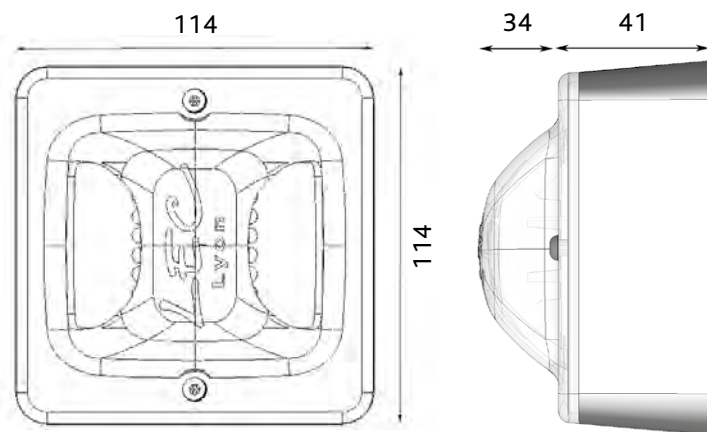

1 ou 2 x (9, 12, 16, 24)

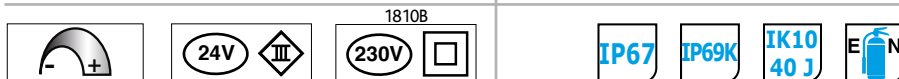

1810 Savoie

1810B



Orelle (France)
Société Française du Tunnel Routier du Fréjus

1820

Sandvika

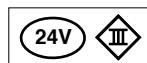
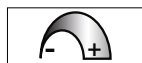
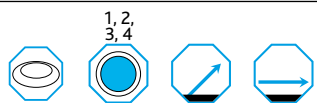
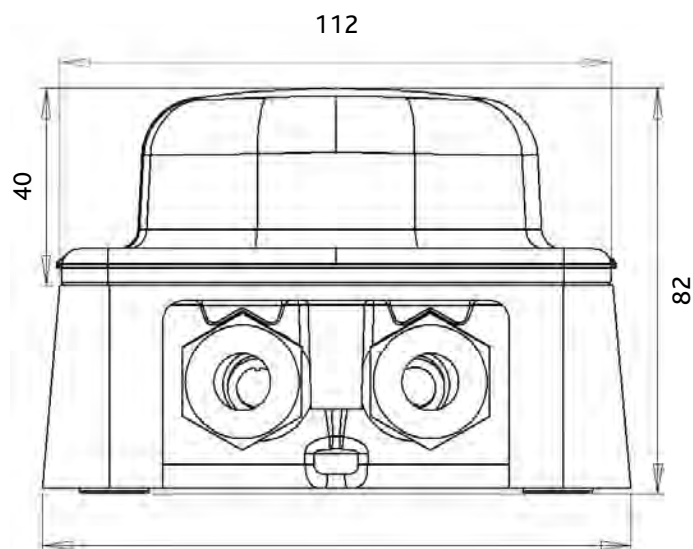

1820

old neon lights

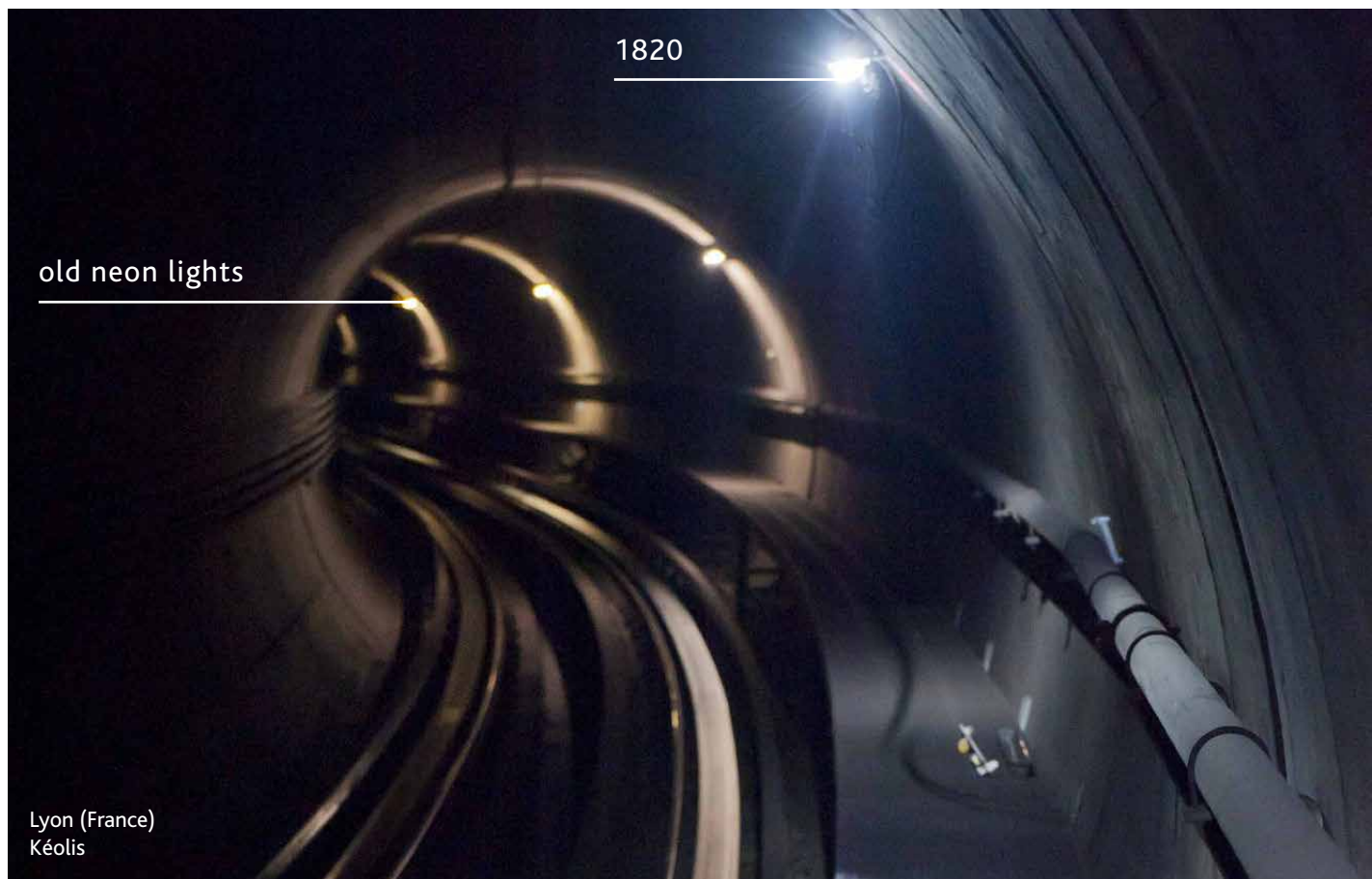

Lyon (France)
Kéolis

1826

Lioran



24

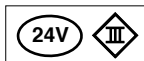
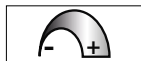
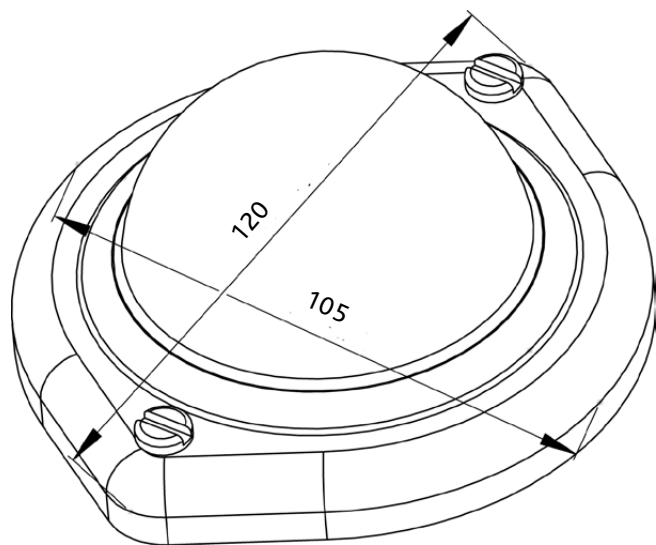

Paris (France)
Lighting Design International





1826 Lioran

1826DF



2 x 24



1826 Lioran

1826S



16





1830 Lucerne



Ø 100



Ø 120



3



1830K



1830+EL



1830+E280



1830+E

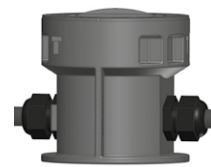

1830+EB



1830+EC

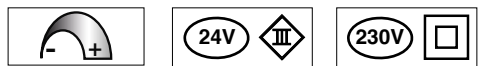
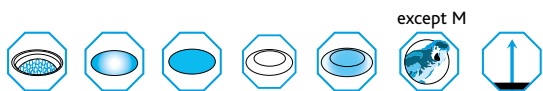

except EB



except D, K

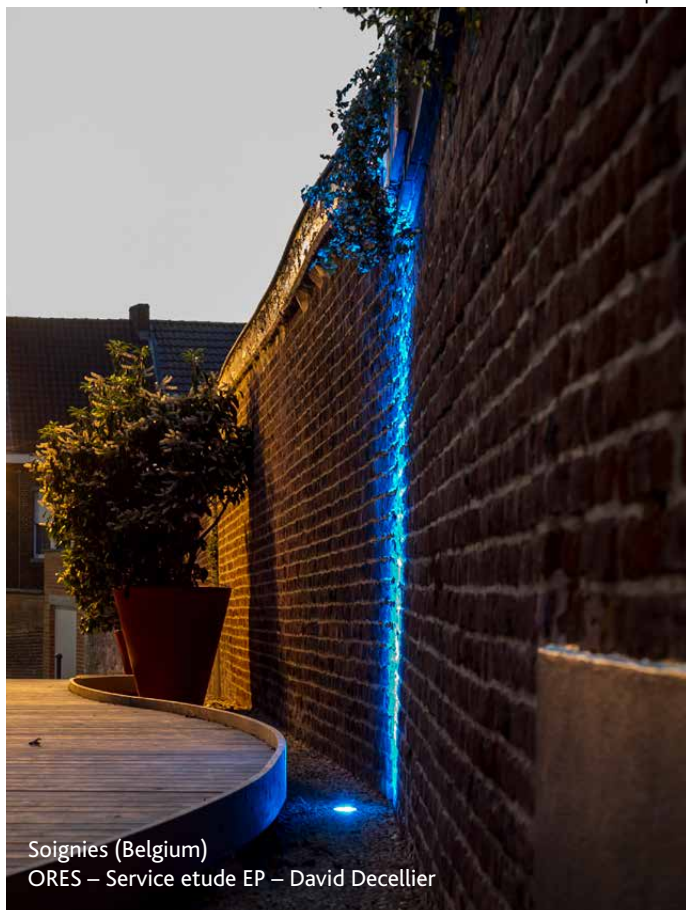

Soignies (Belgium)
ORES – Service etude EP – David Decellier



Dorchester (UK)
Town of Dorchester



1830 Lucerne

1830



1830S



1830H



1830K

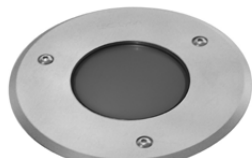

1830KH

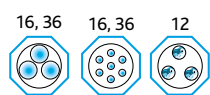

Lorient (France)
Agence ON

1830 Lucerne

1830M



Lyon (France)
Saint Exupéry Airport

1832 Angouleme

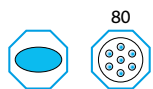
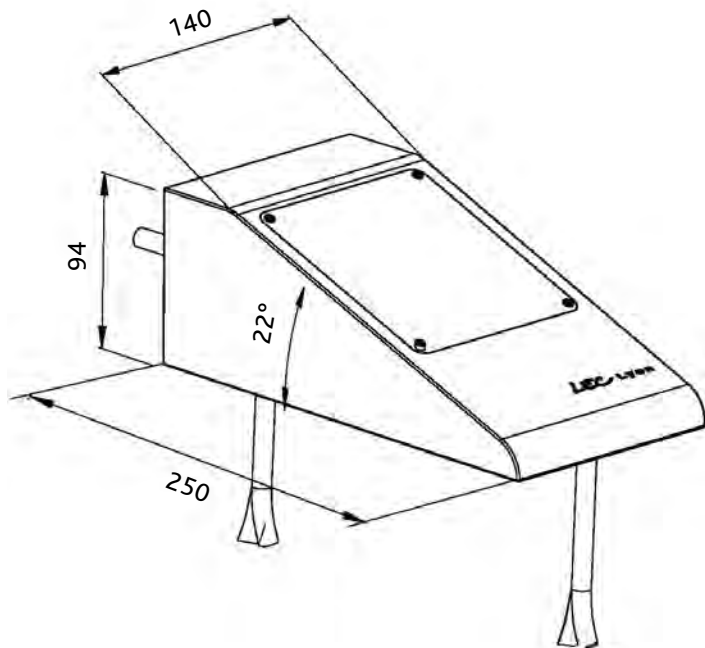

La Garde (France)
Town of La Garde

1836

Ville de Paris

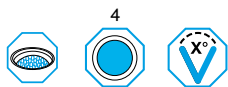
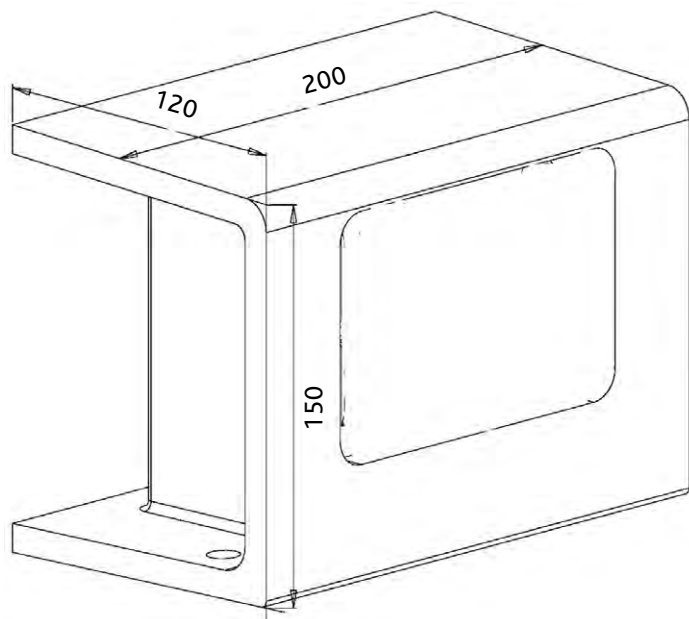

Nîmes (France)
Côté Lumière

1843 Palais Royal

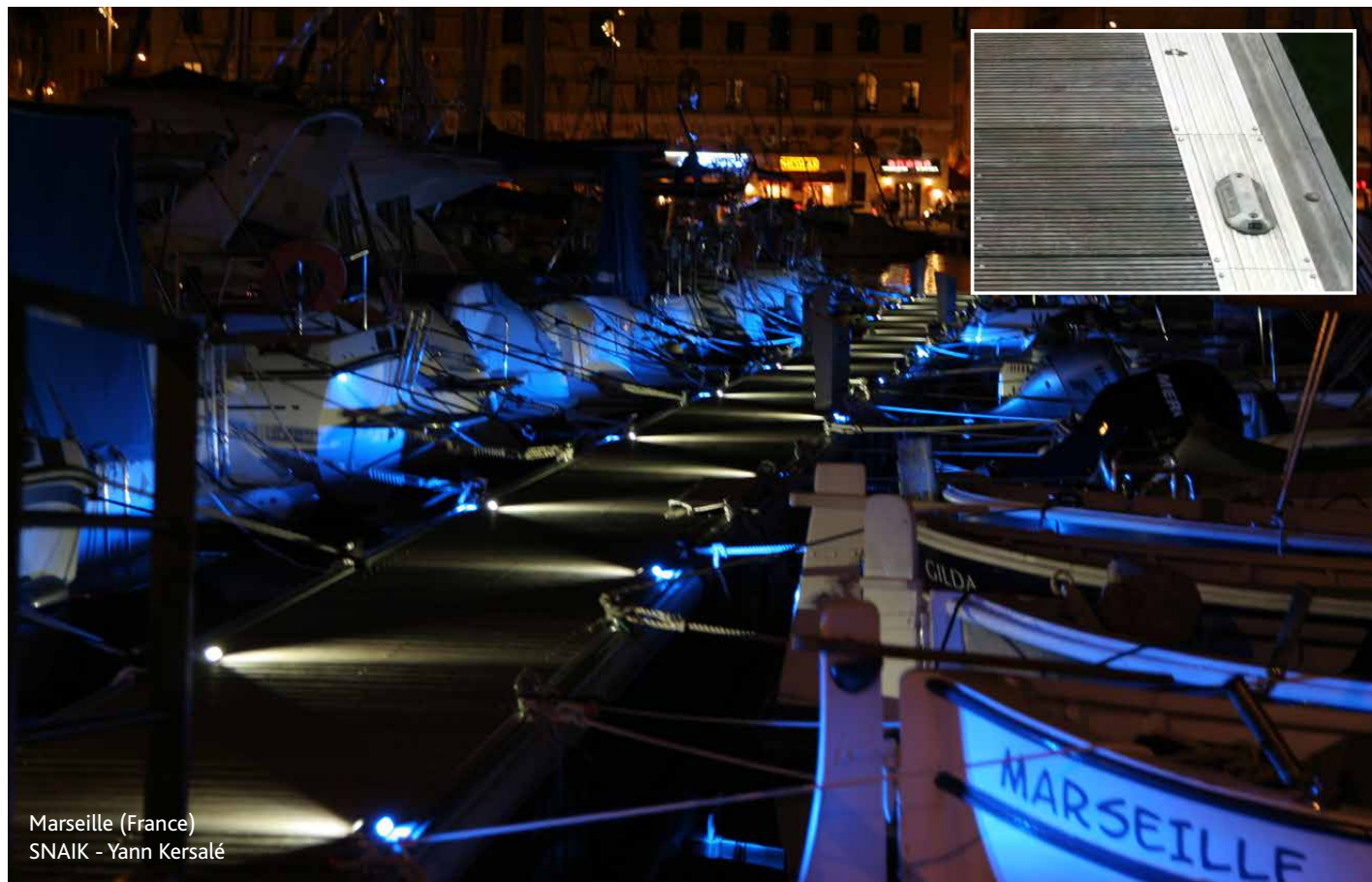
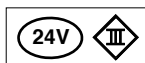
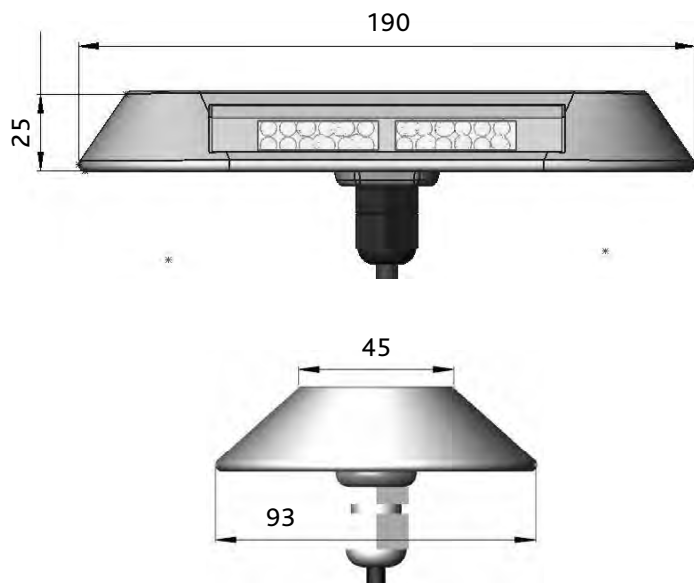

Marseille (France)
SNAIK - Yann Kersalé



1843 Palais Royal
1843G

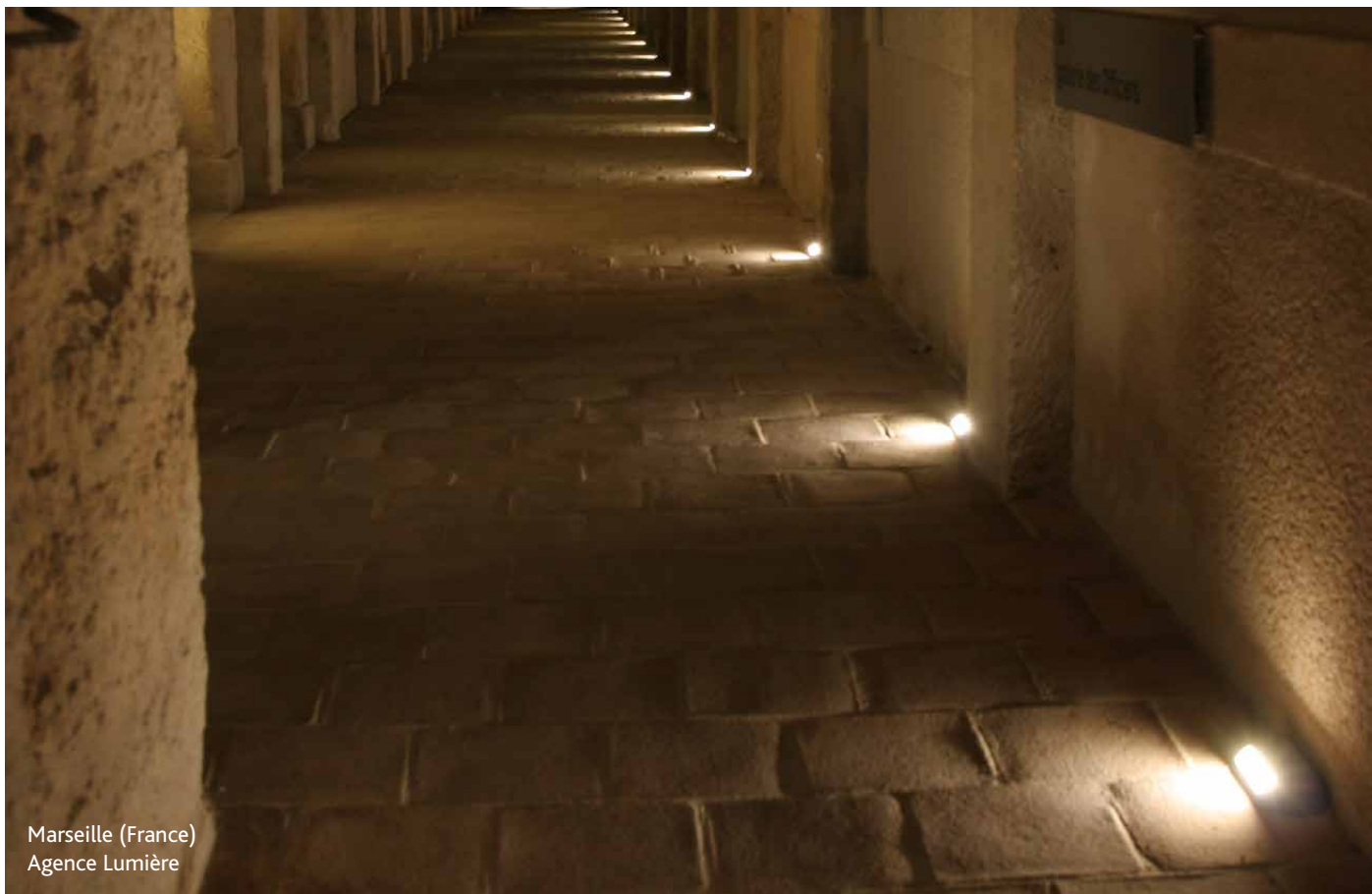
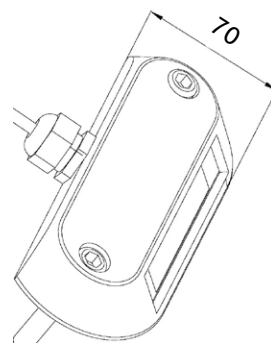
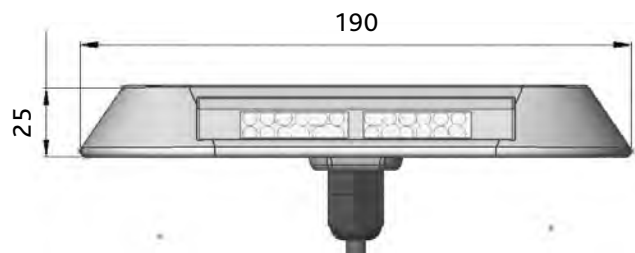

Marseille (France)
Agence Lumière

1844 Saint Raphael



17 mm

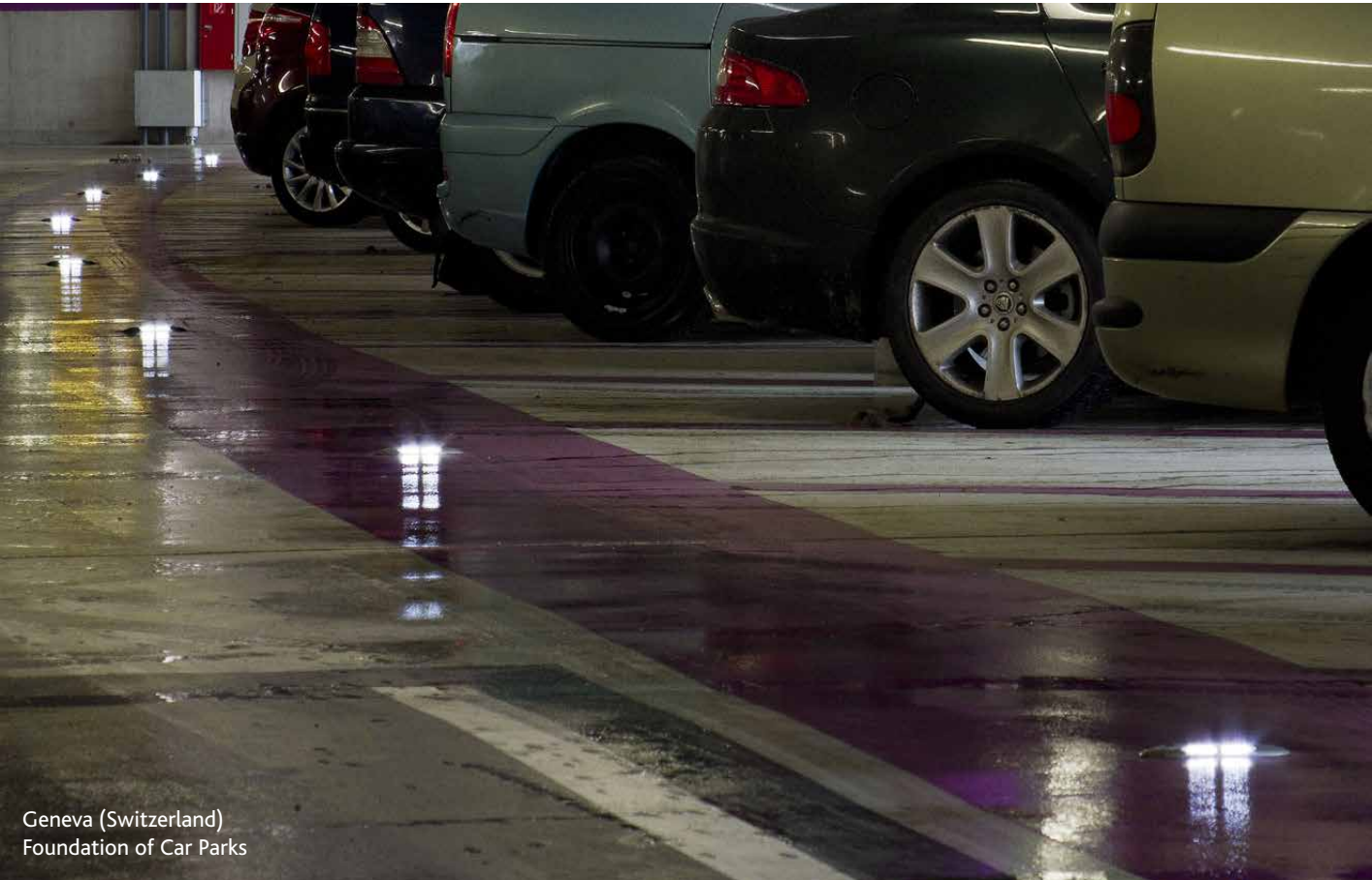
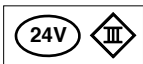
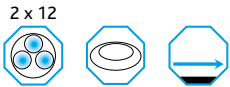
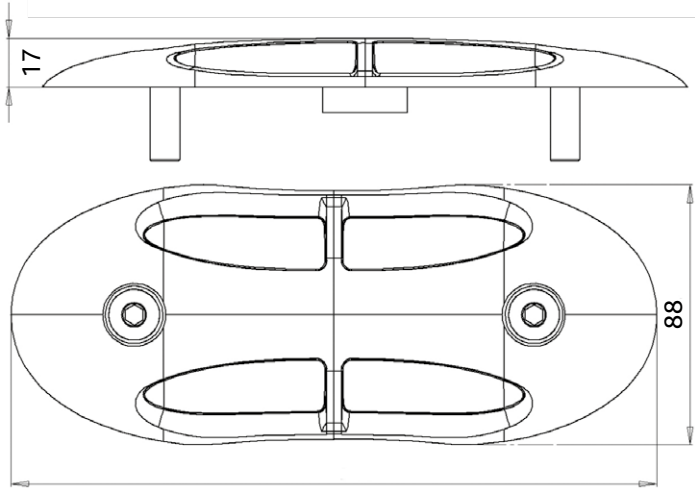

Geneva (Switzerland)
Foundation of Car Parks

1950 Lugano

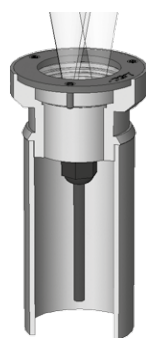
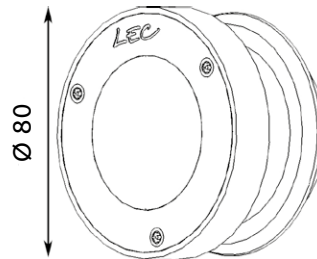

1950+E150

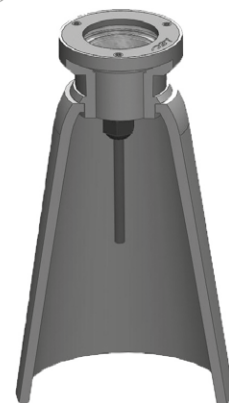

1950+E250

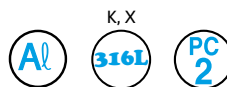

1950 Lugano

1950



1950H



1950KH

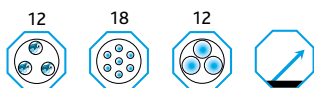

2852

Pyramide

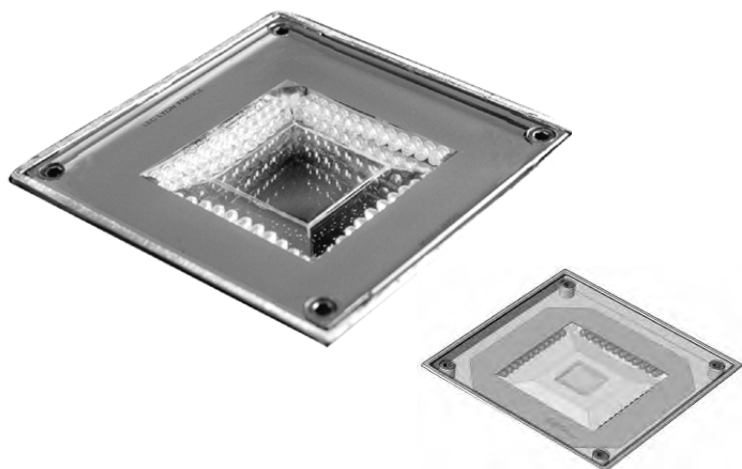

2852P

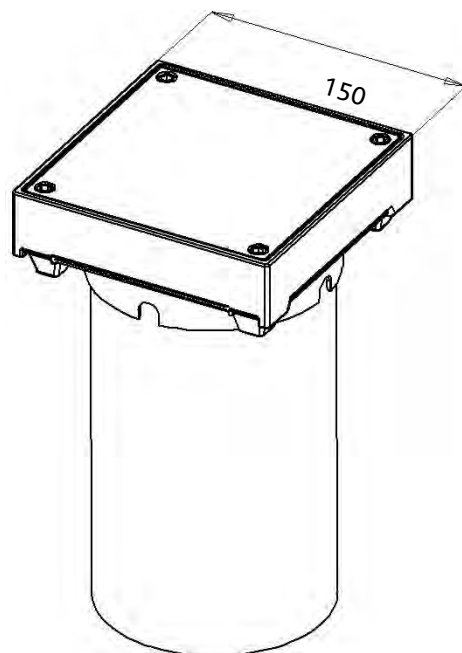

2852+EL

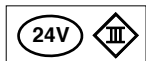

P

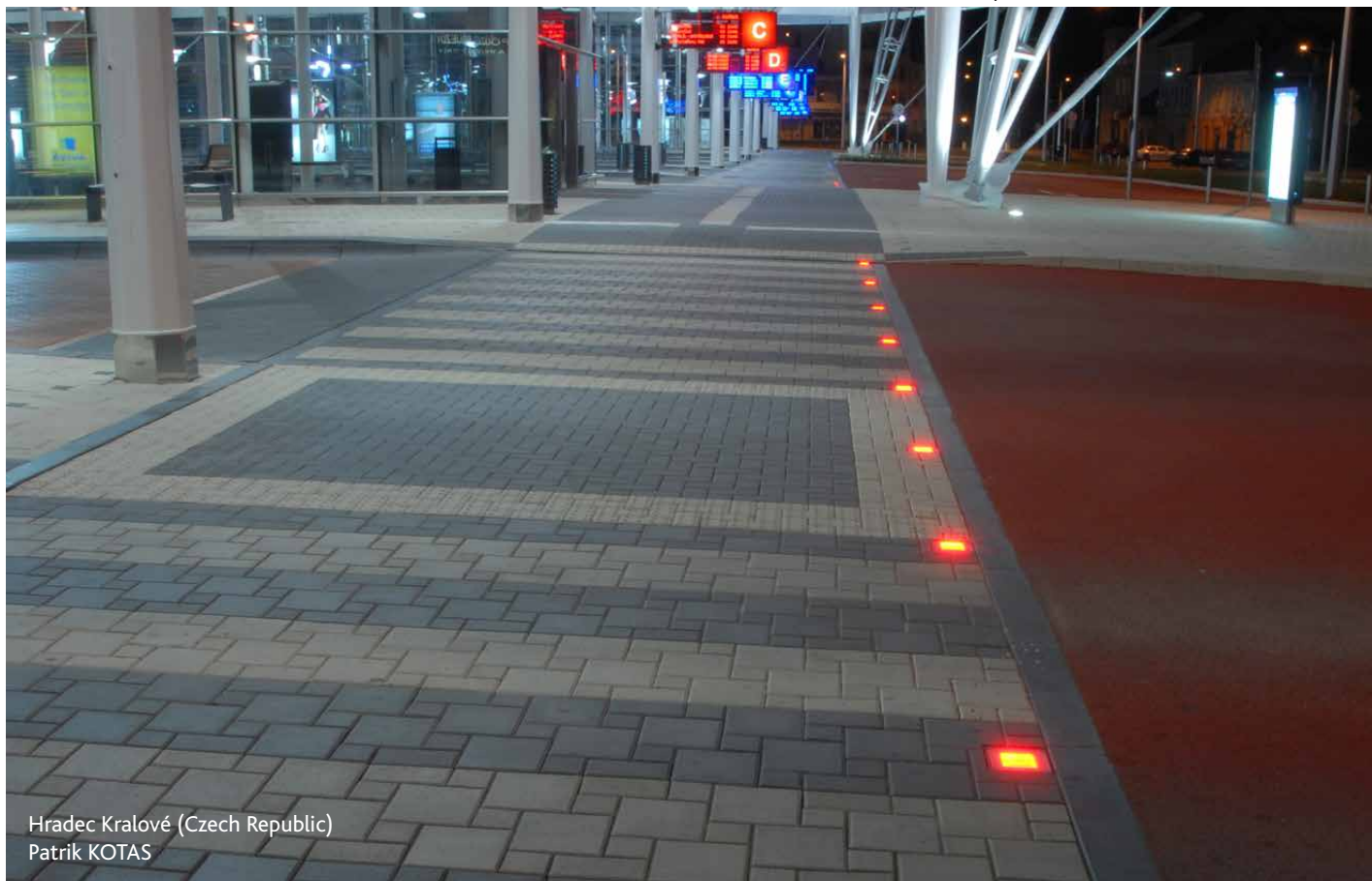

Hradec Kralové (Czech Republic)
Patrik KOTAS

2852 Pyramide

2852H

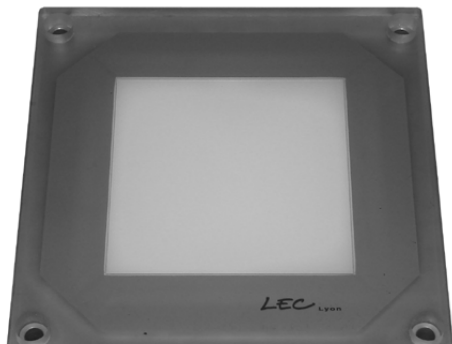

2852 Pyramide

2852 + EA

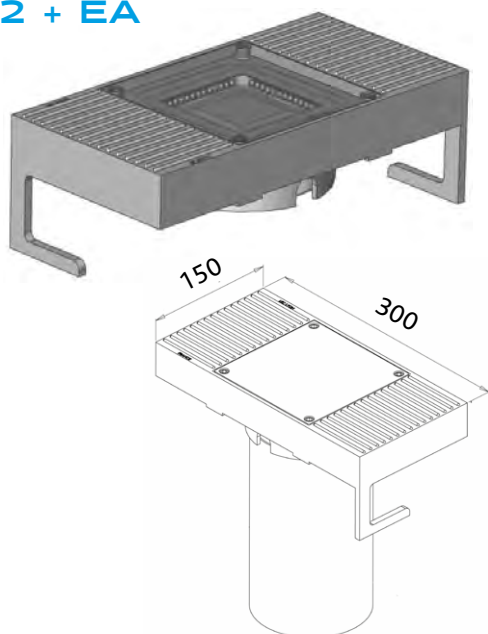

2852 Pyramide

2852 + ET

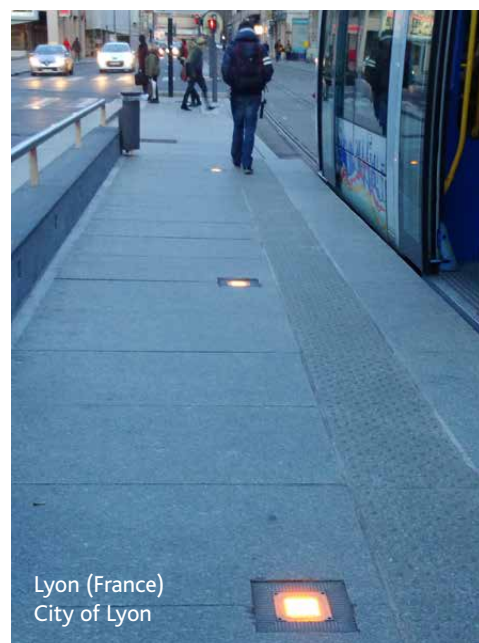
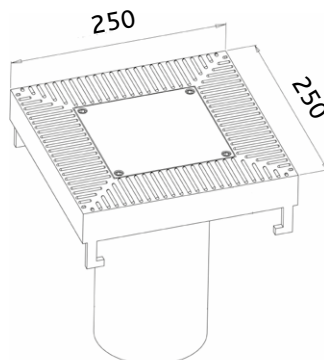
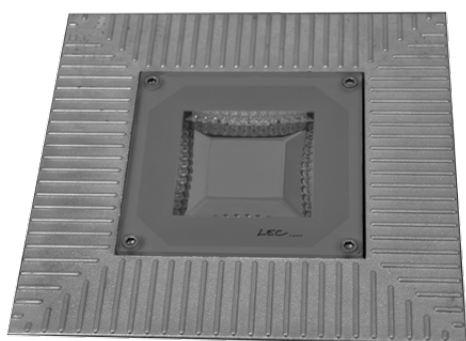

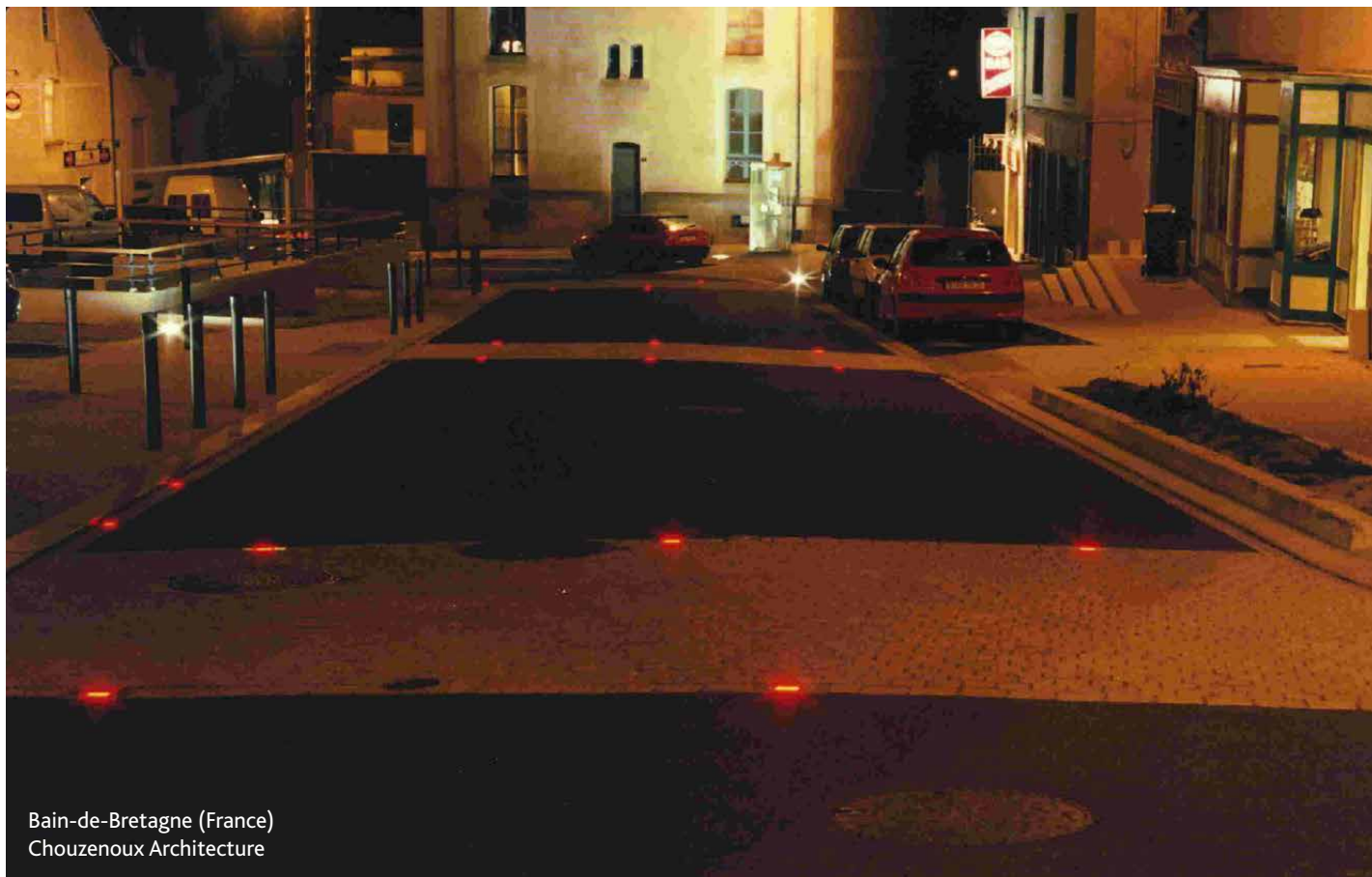
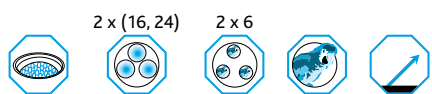
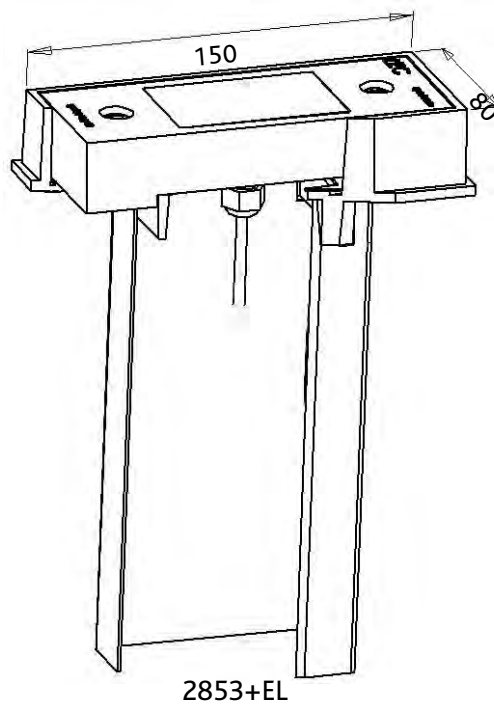

Bain-de-Bretagne (France)
Chouzenoux Architecture

Paris (France)
Daniel Buren



2855

Meteor

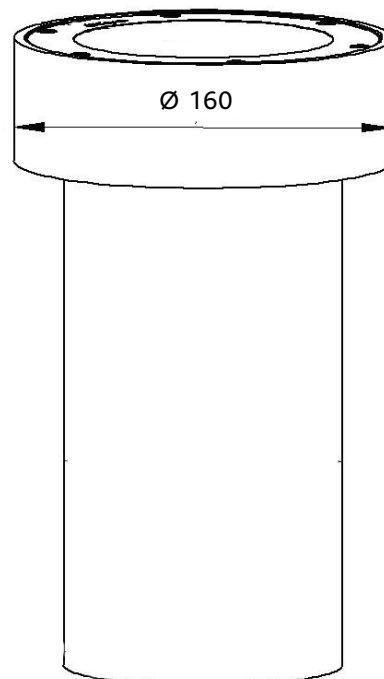

2855+EL

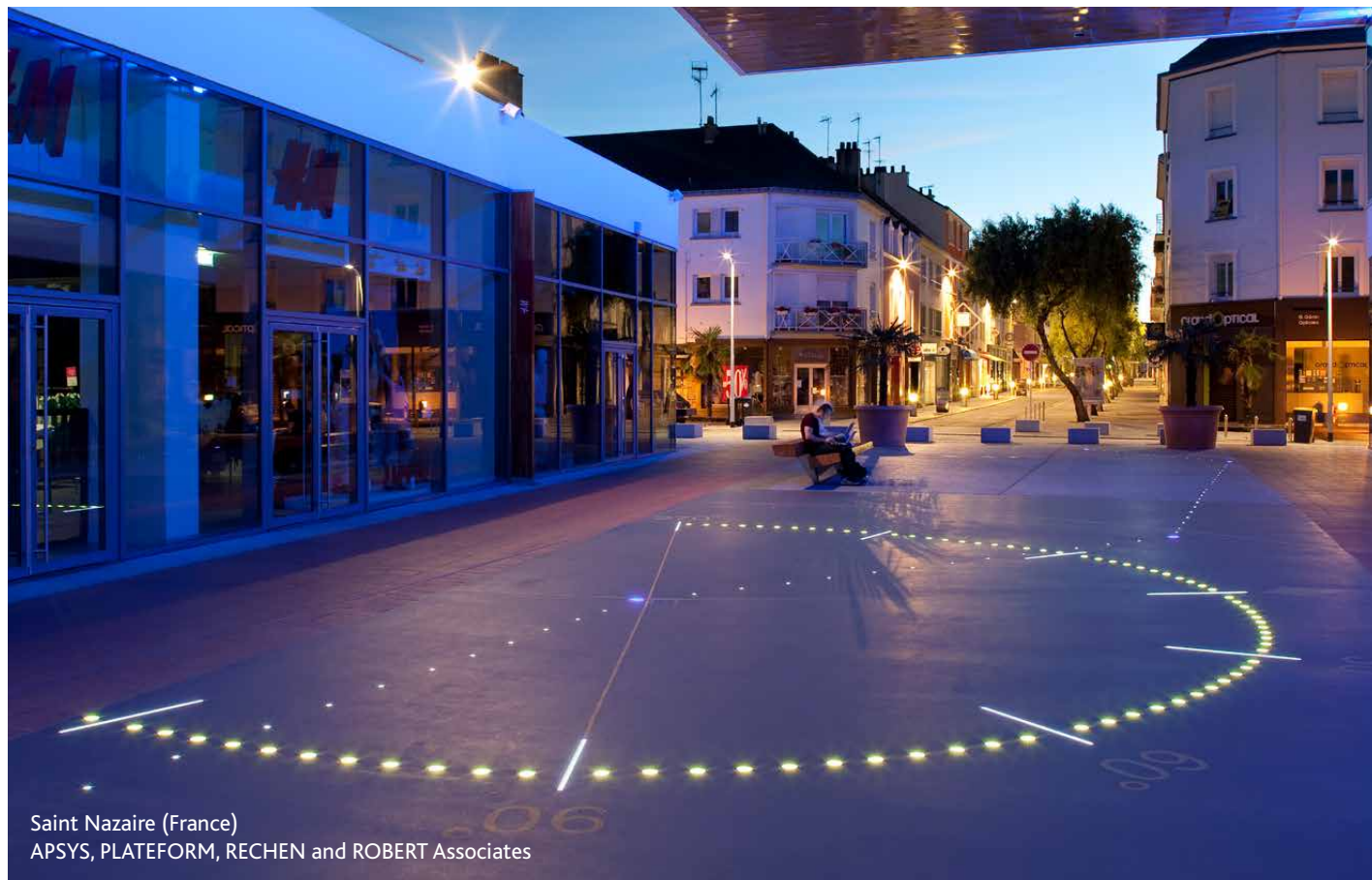
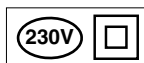
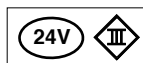
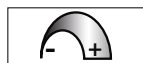

Saint Nazaire (France)
APSYS, PLATEFORM, RECHEN and ROBERT Associates



2855 Meteor

2855



2855P

36, 48



P



2855 Meteor

2855H



45



48



2858

Philae

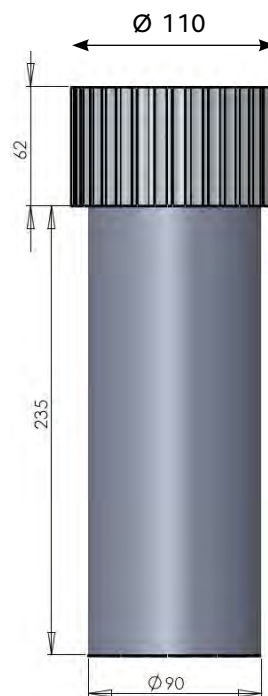

2858+EL

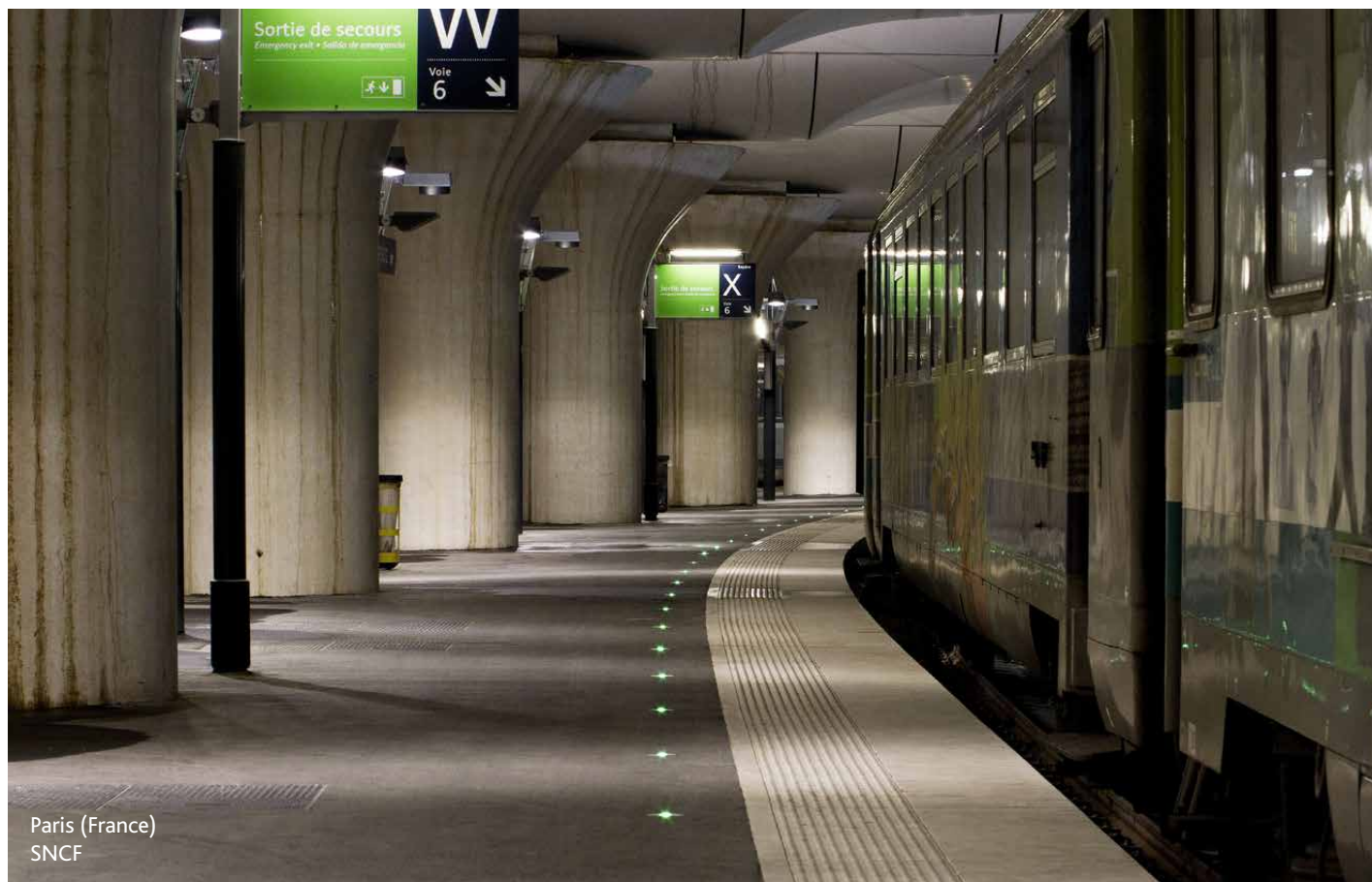
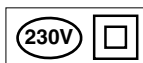
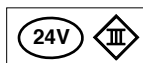
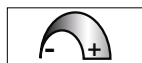
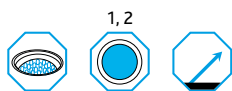

Paris (France)
SNCF

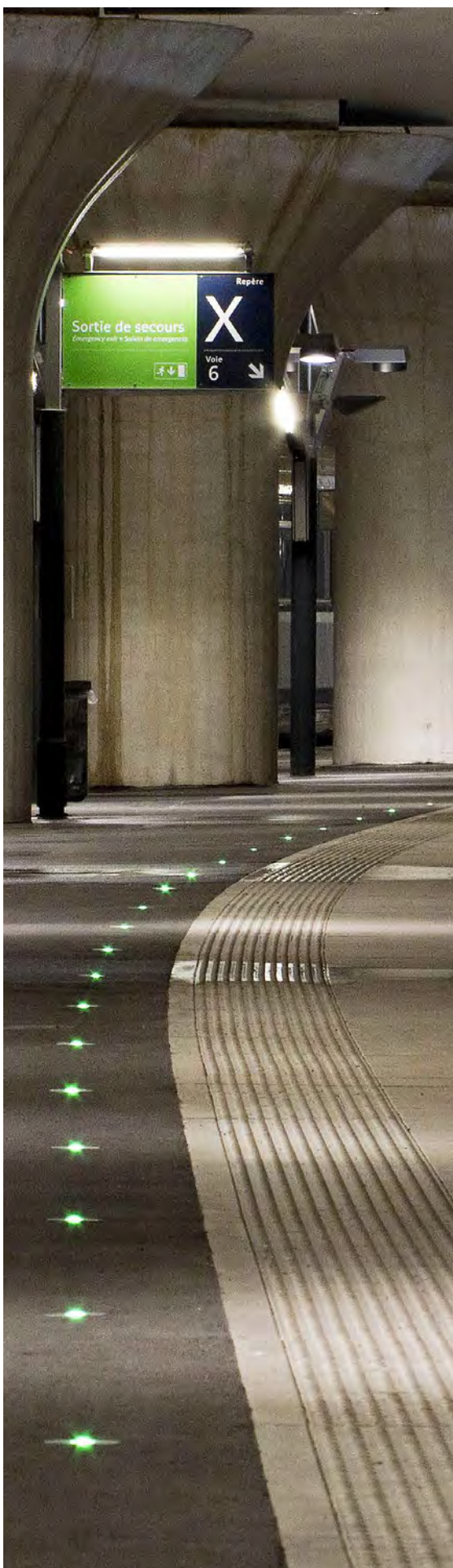

4010

Luminy

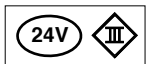
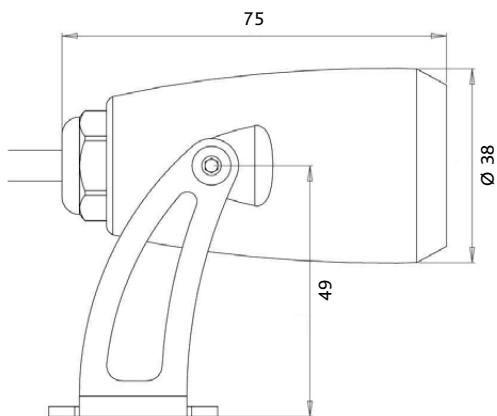

Paris (France)
Concepto

4020

Luminy 2



4022X

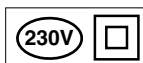
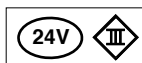
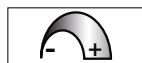
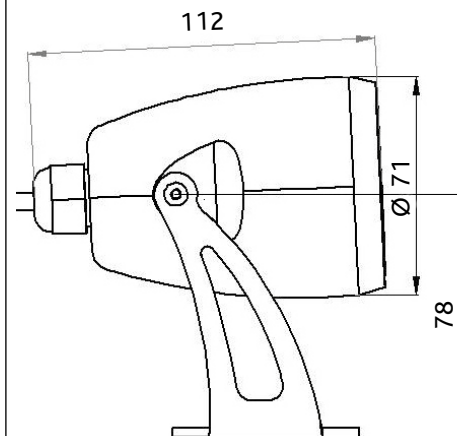

4021



Rocourt (Belgium)
RESA

4040

Luminy 4

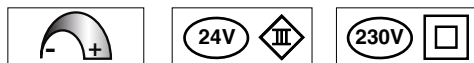
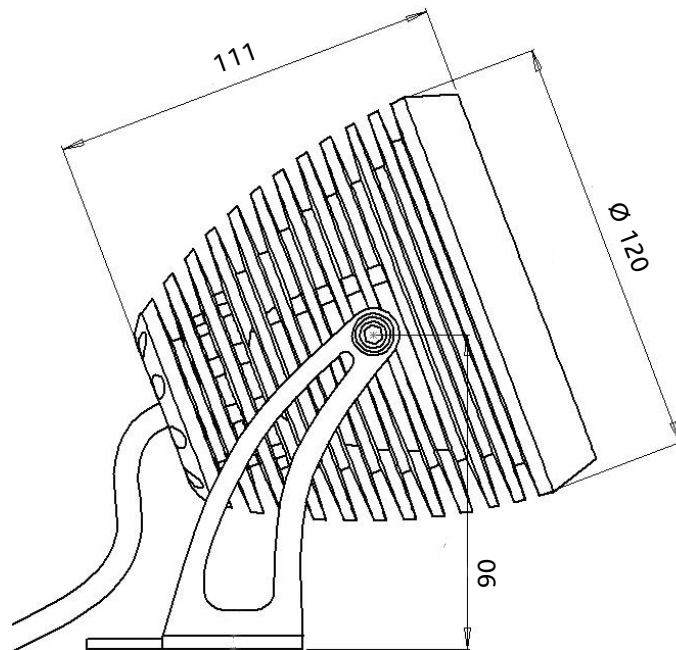

London (UK)
Speirs + Major



4040 Luminy 4

4042X

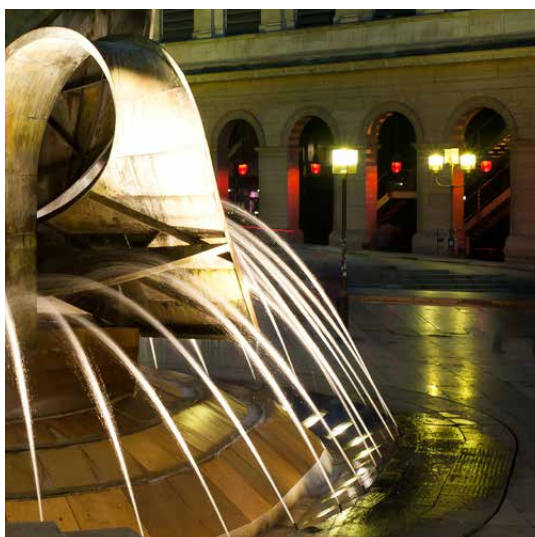

Lyon (France)
City of Lyon

4060 Luminy 6

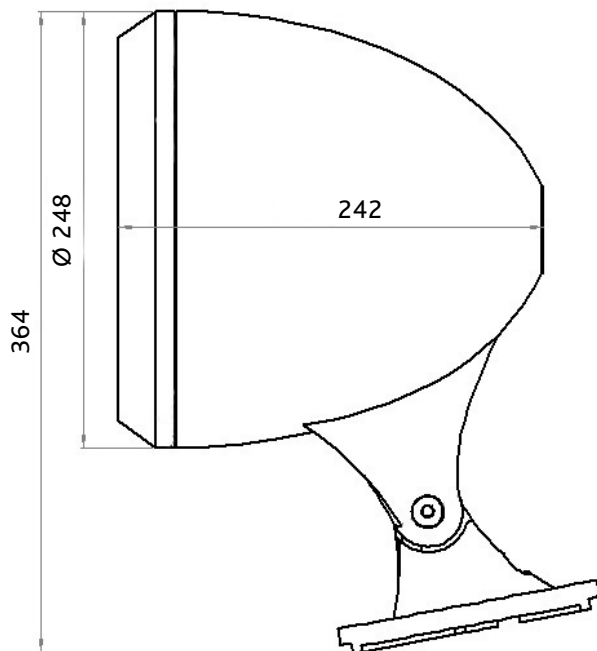

4060 Luminy 6

4060CAP



Amiens (France)
Town of Amiens



Carpentras (France)
ECL Studio



4130 Vulcano

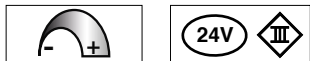
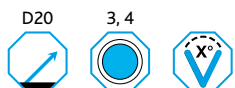
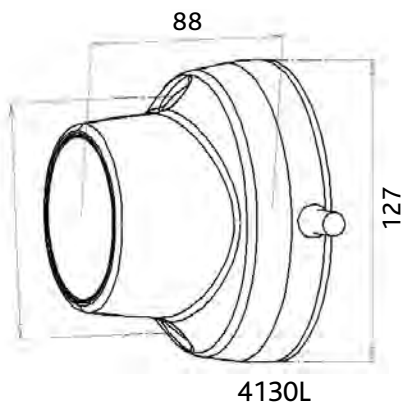

4130 Vulcano

4130



4130 Vulcano

4130BS

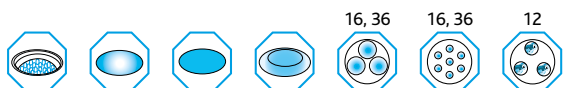

London (UK)
Townshend

4240

Havre

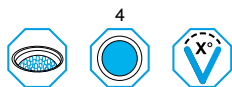
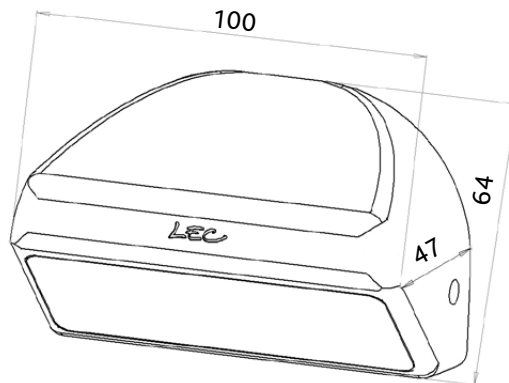

Calvi (France)
Horizons Paysages

4330 Saint Jean

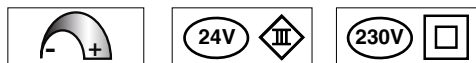
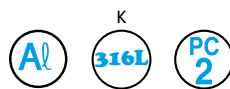
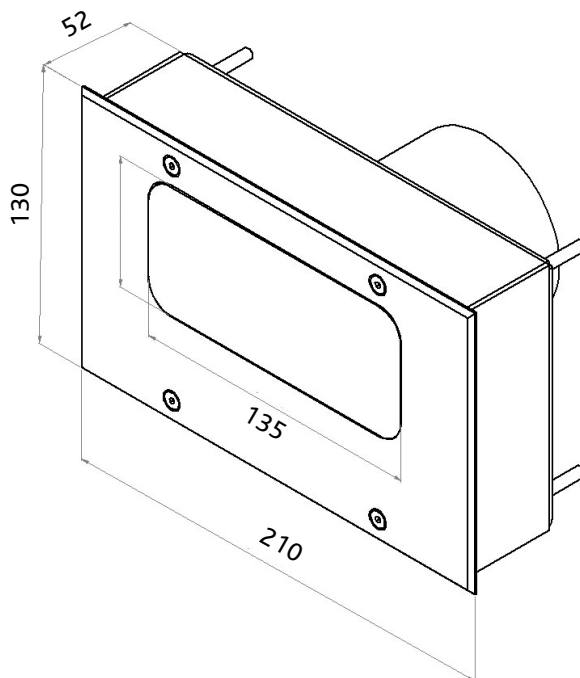

Quimperlé (France)
SNAIK-Yann Kersalé-Light Art

4440 Lumikub 4



03/2017

NEW

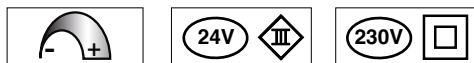
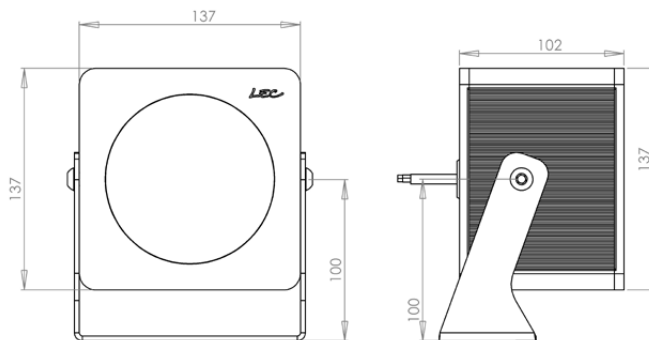
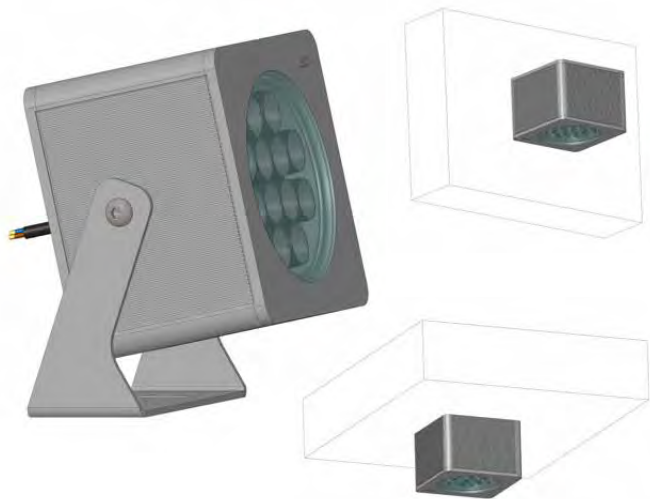

4420 Lumikub 2

TO COME*



4450 Lumikub 5

TO COME*



4660

Corsica



NEW

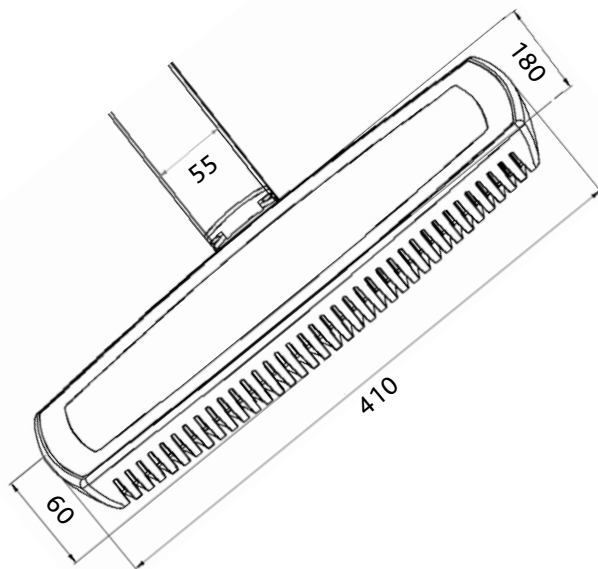

4660 Corsica

4660CAP

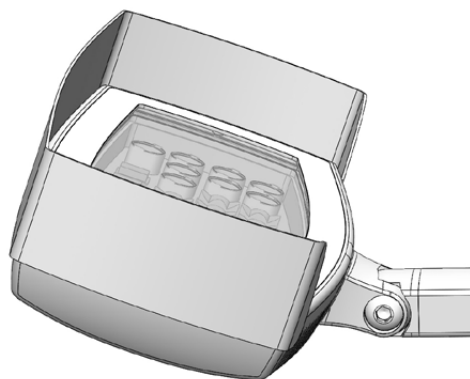

Bonifacio (France)
Agence Lumière

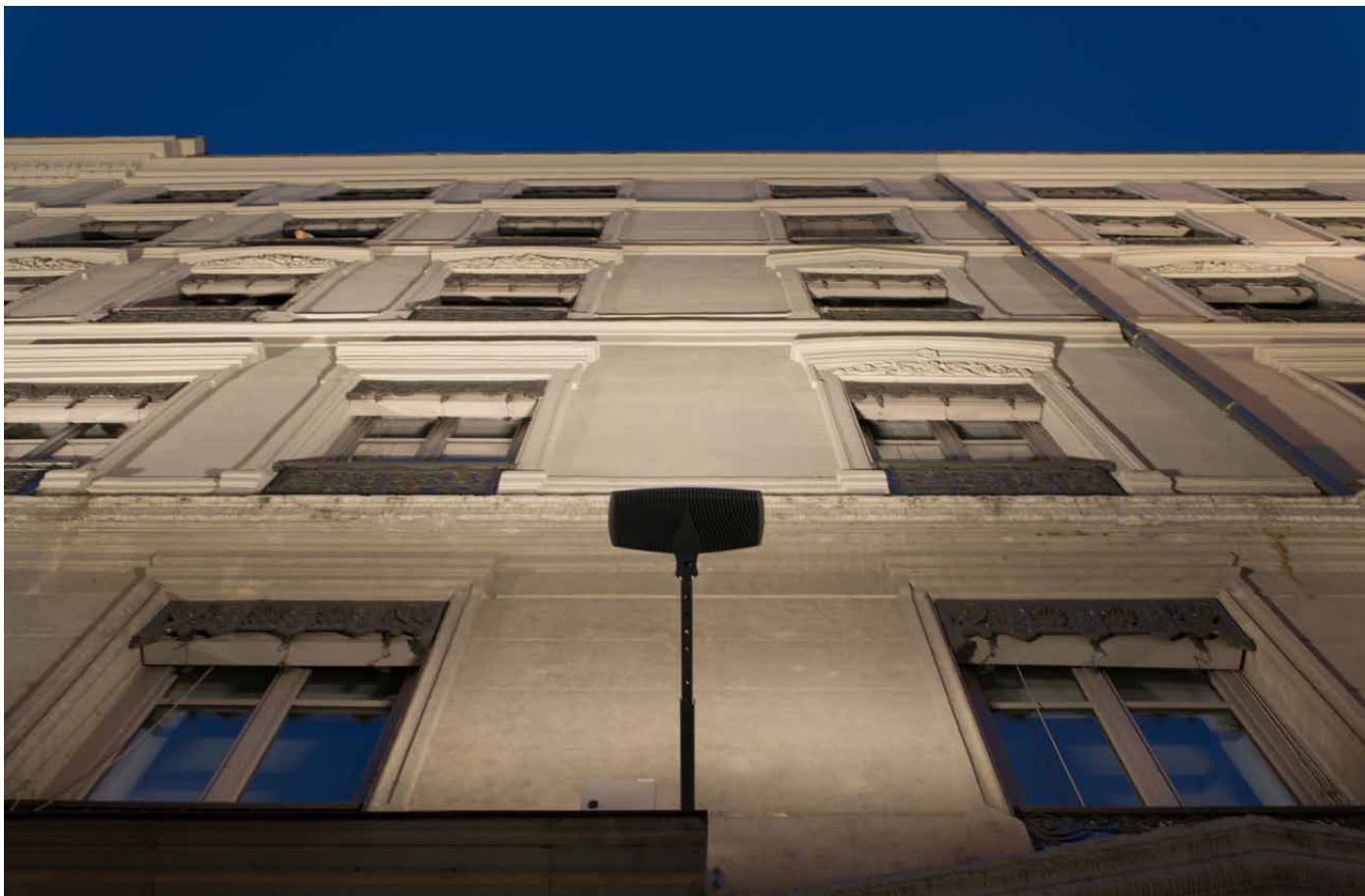

Lyon (France)
Atelier Roland Jeol

5432

Stone 10

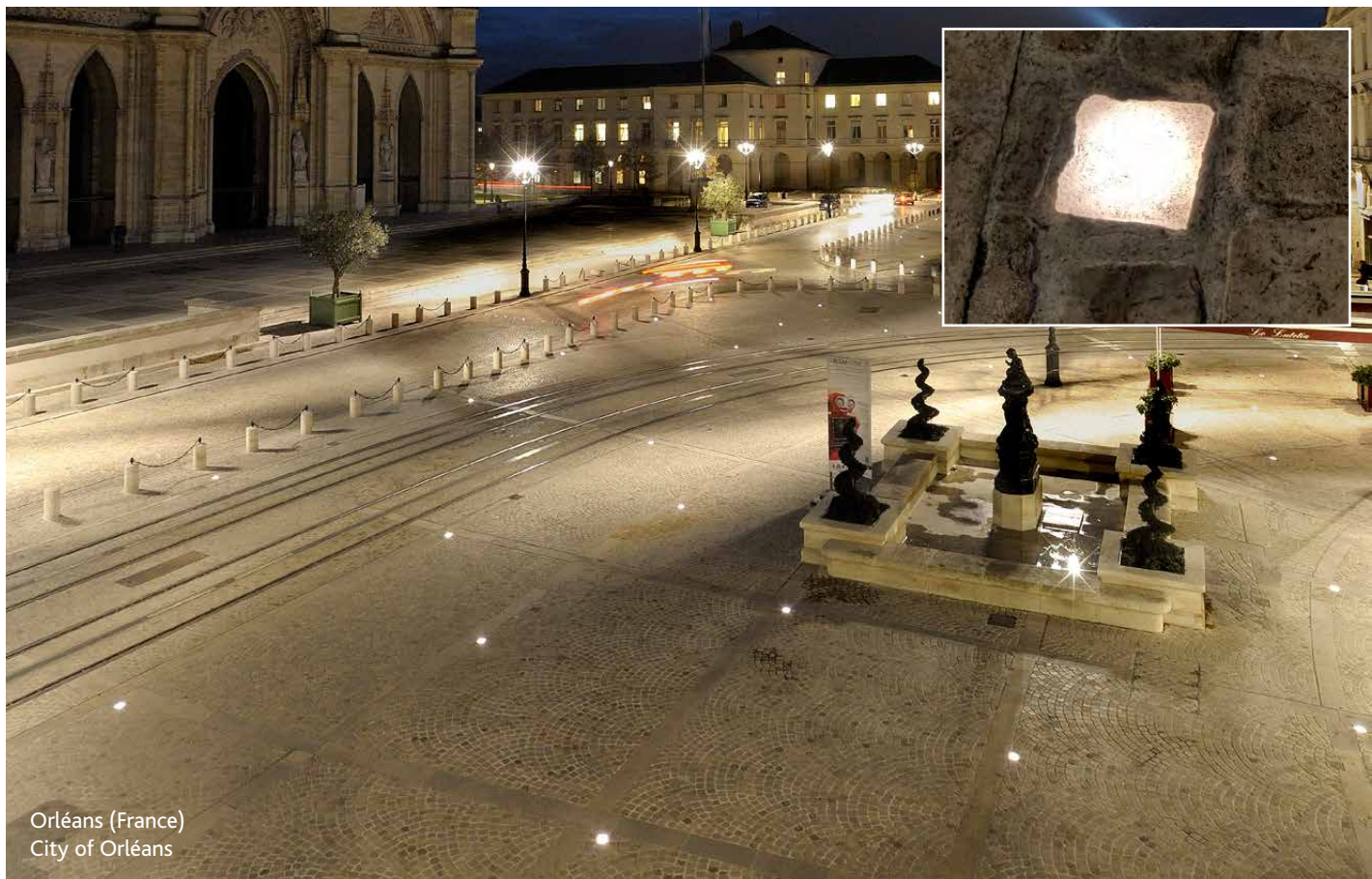
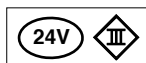
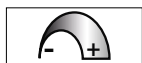
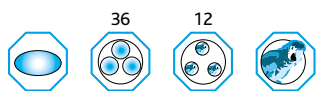
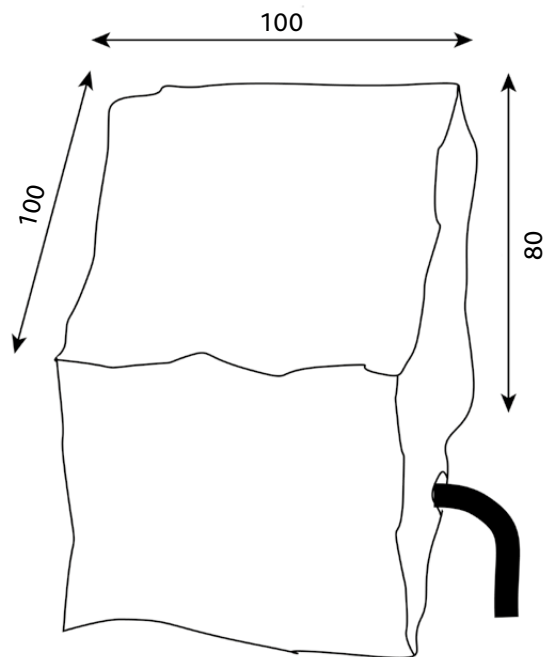

Orléans (France)
City of Orléans



5533

Soulary



NEW

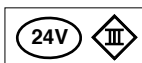
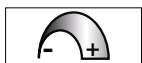
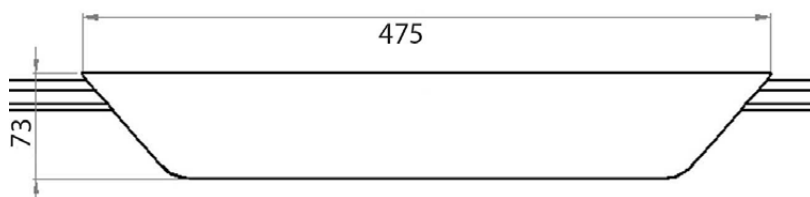

5620

Brunei



5620E2

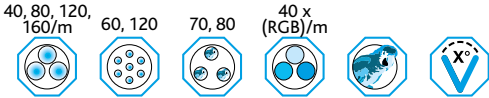
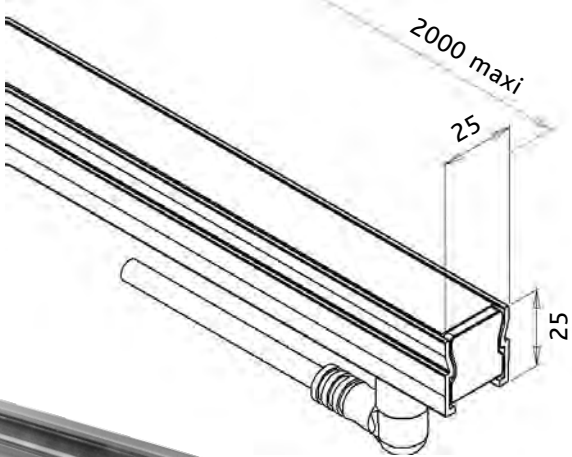

Offenbach am Main (Germany)
EVO



Greenwich (UK)
Speirs + Major

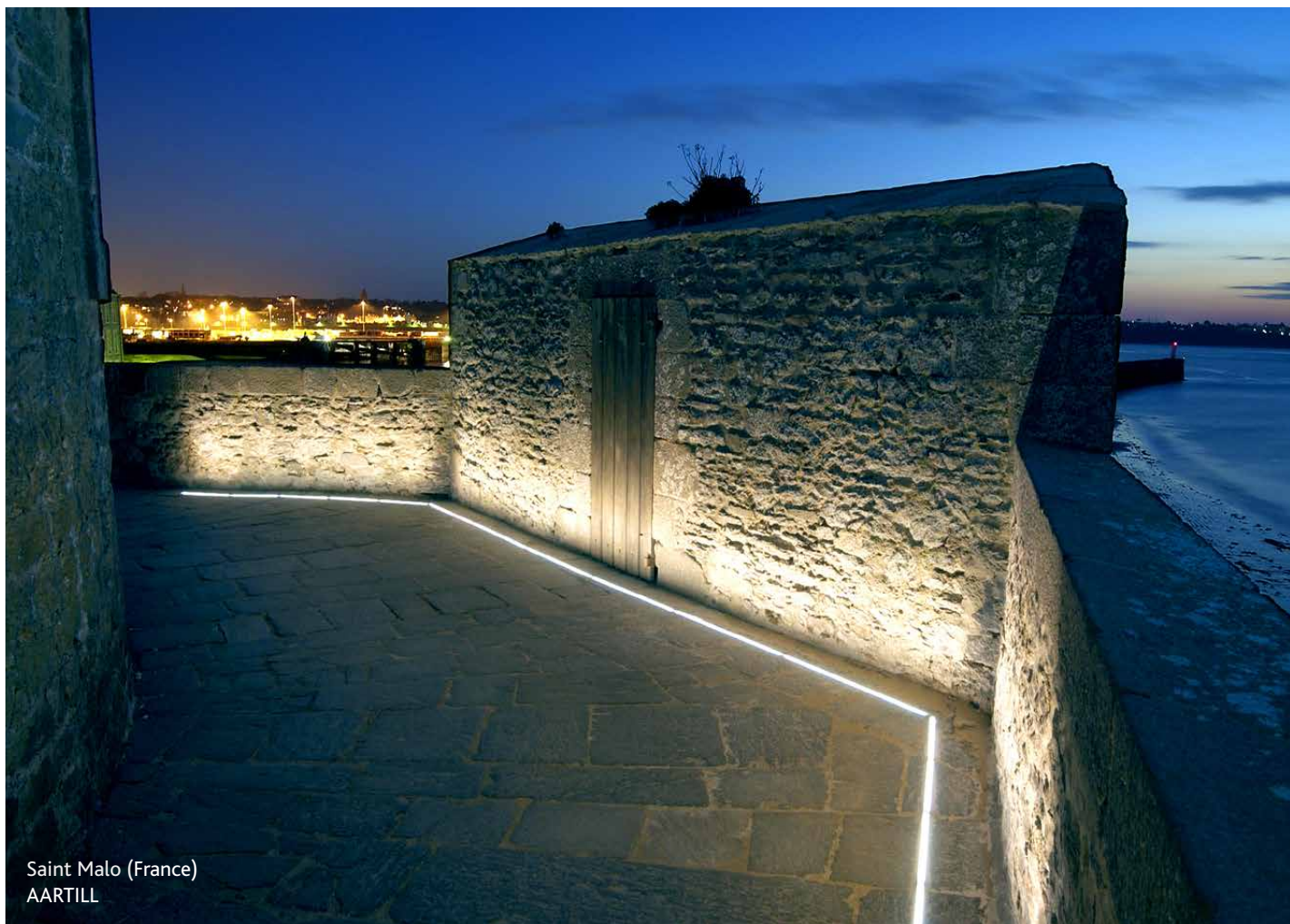

Saint Malo (France)
AARTILL



5620

Brunei

5623

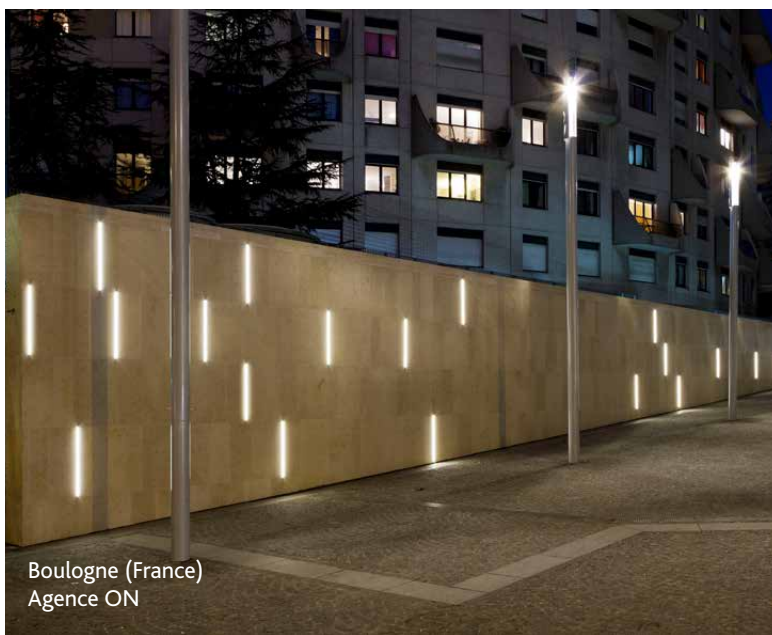
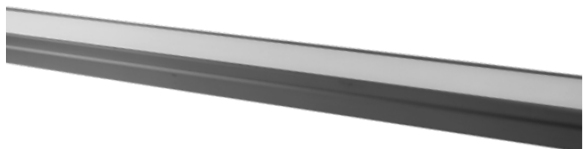

Boulogne (France)
Agence ON

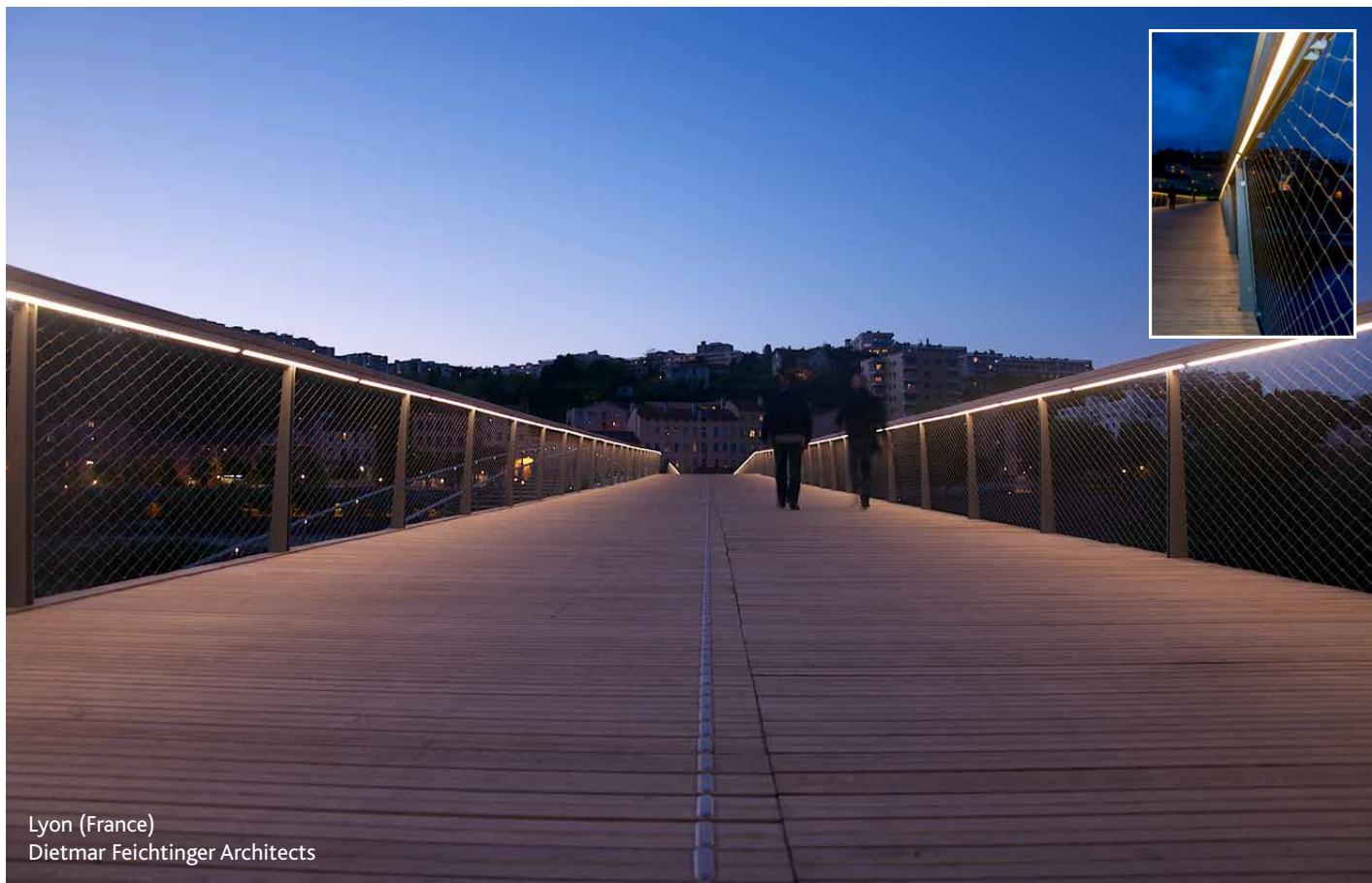

Lyon (France)
Dietmar Feichtinger Architects

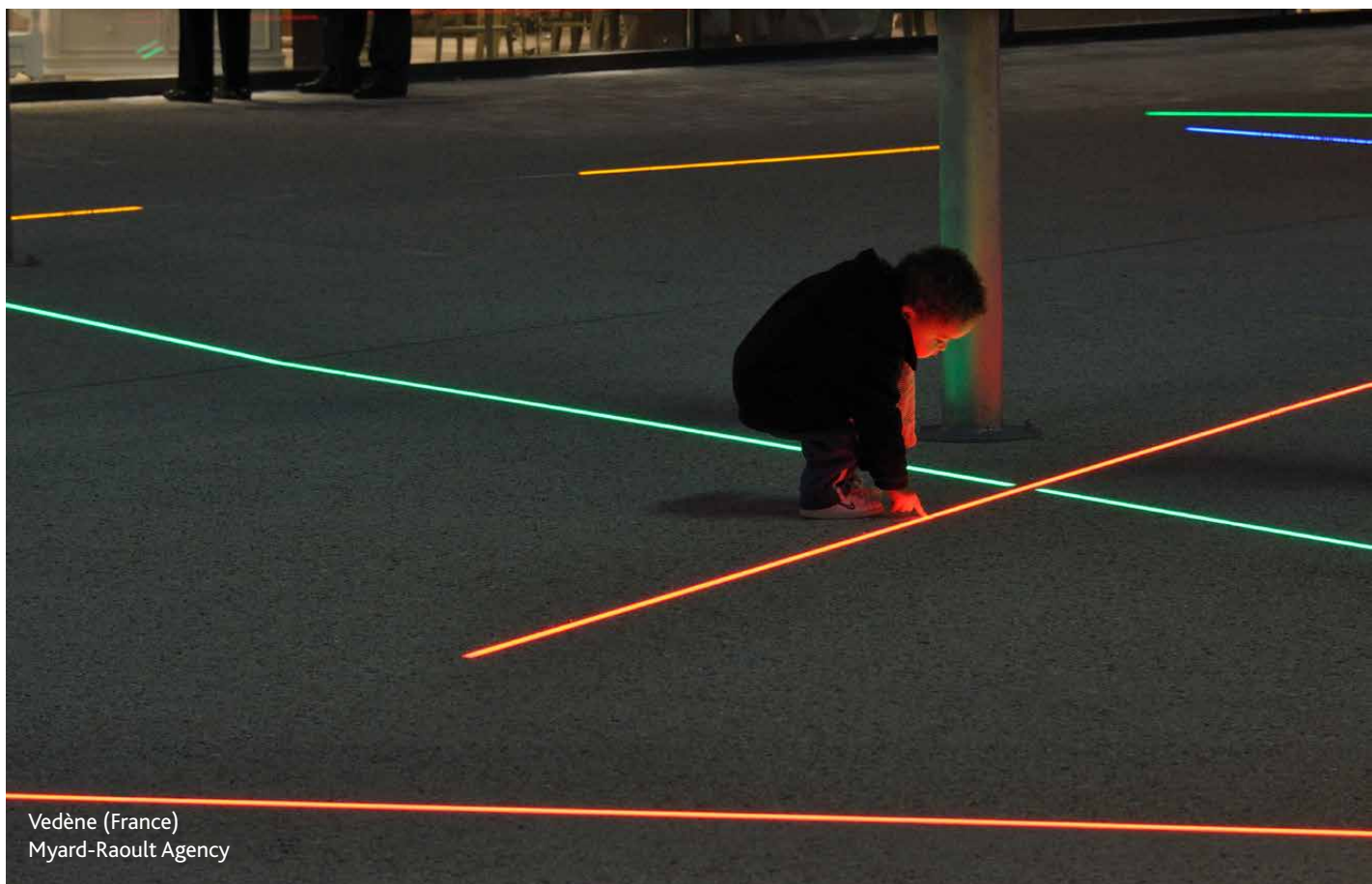

Vedène (France)
Myard-Raoult Agency

5624

Libourne



11/2017

NEW

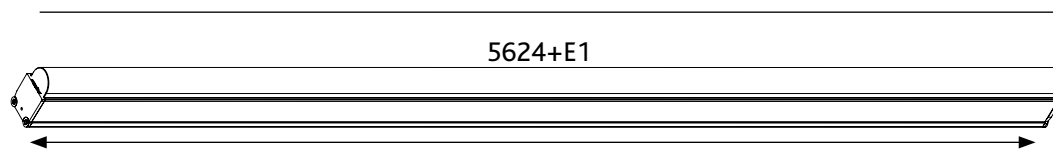
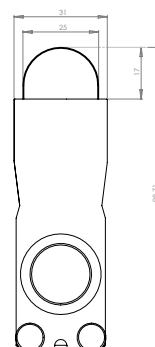
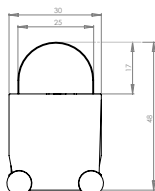

5624+E1

2 000 maxi

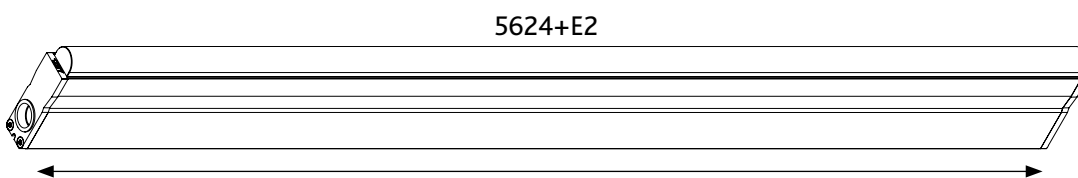

5624+E2

2 000 maxi

60, 120



70, 80

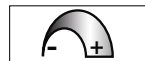
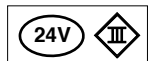

5625

Linealec

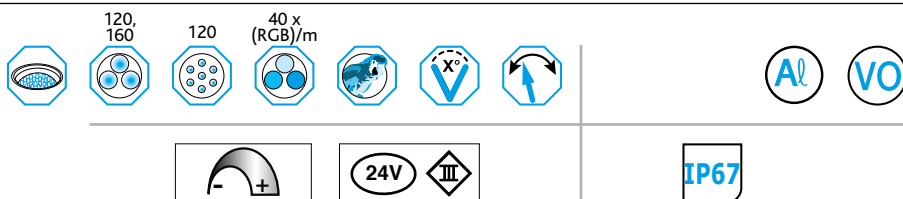
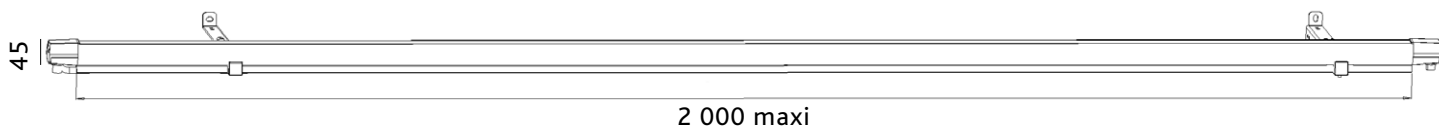

Namur (Belgium)
Radiance 35 and ORES

5630

Belval

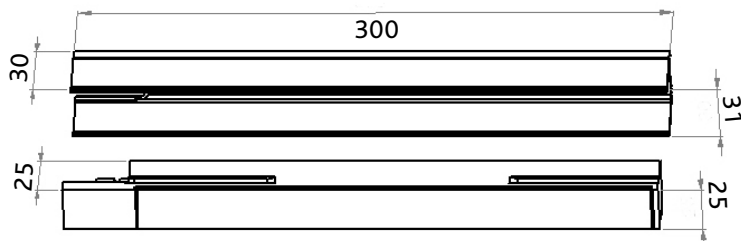

5630 + E1

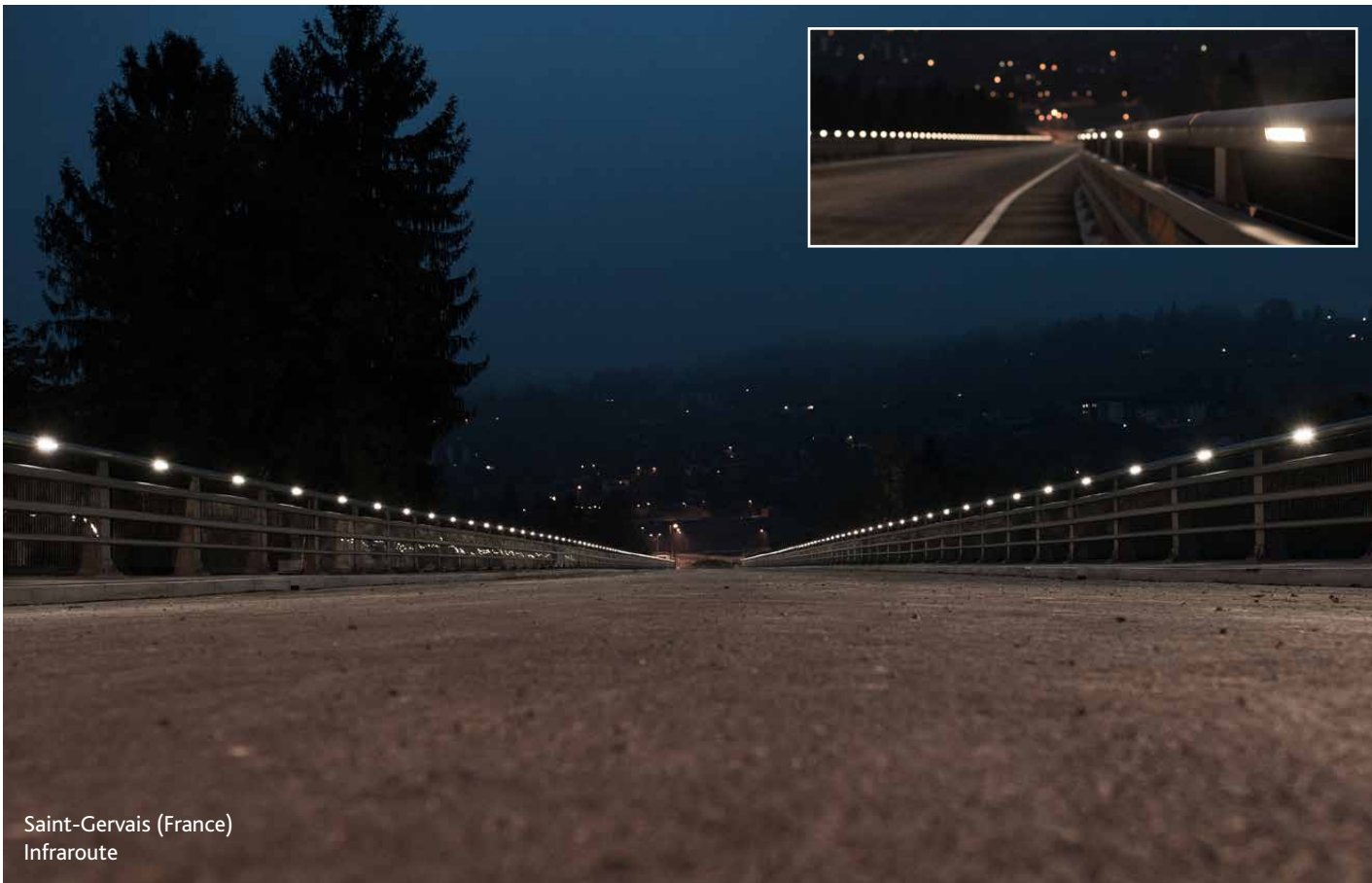

Saint-Gervais (France)
Infraroute

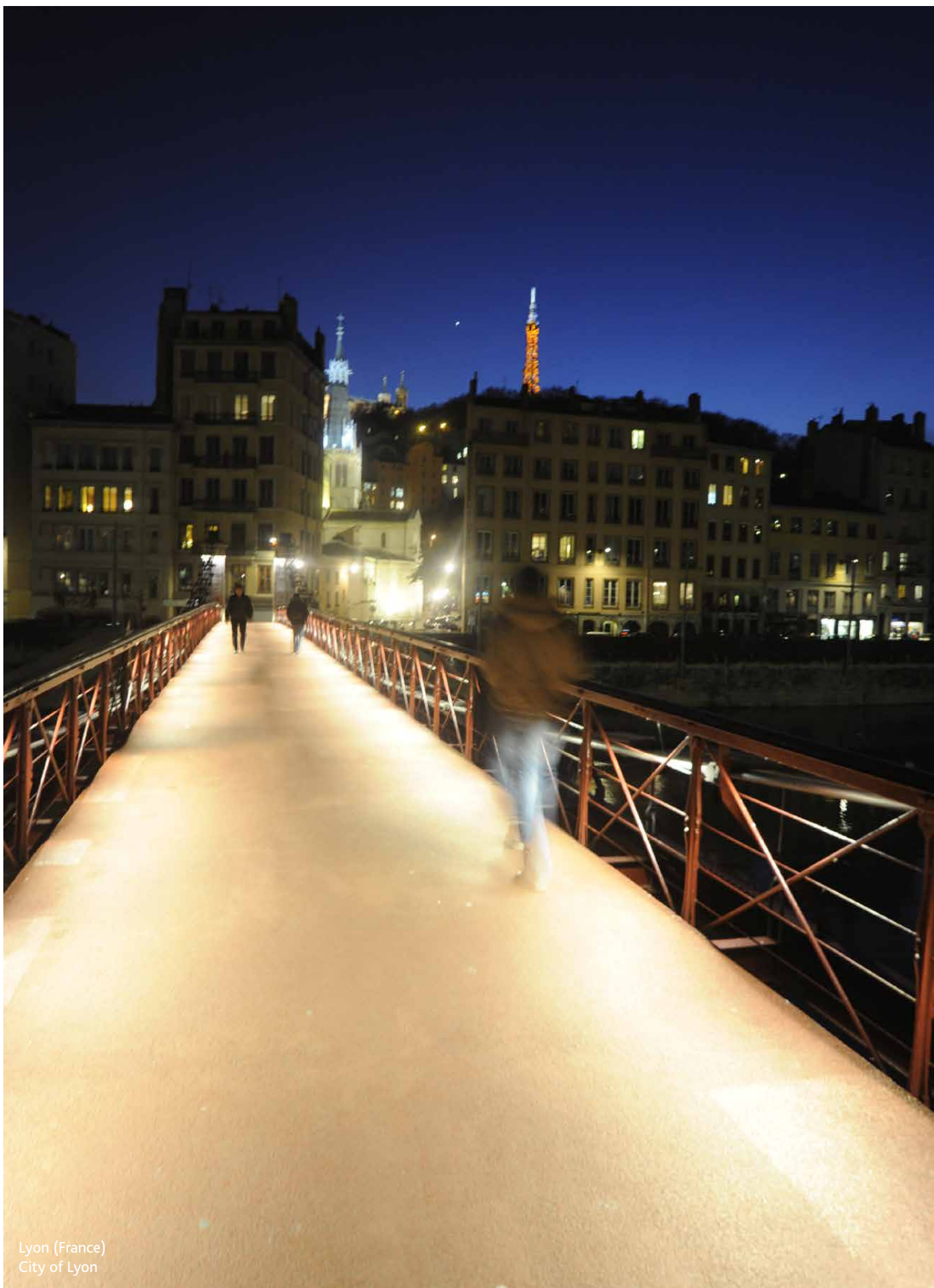

Lyon (France)
City of Lyon

5633

Arches

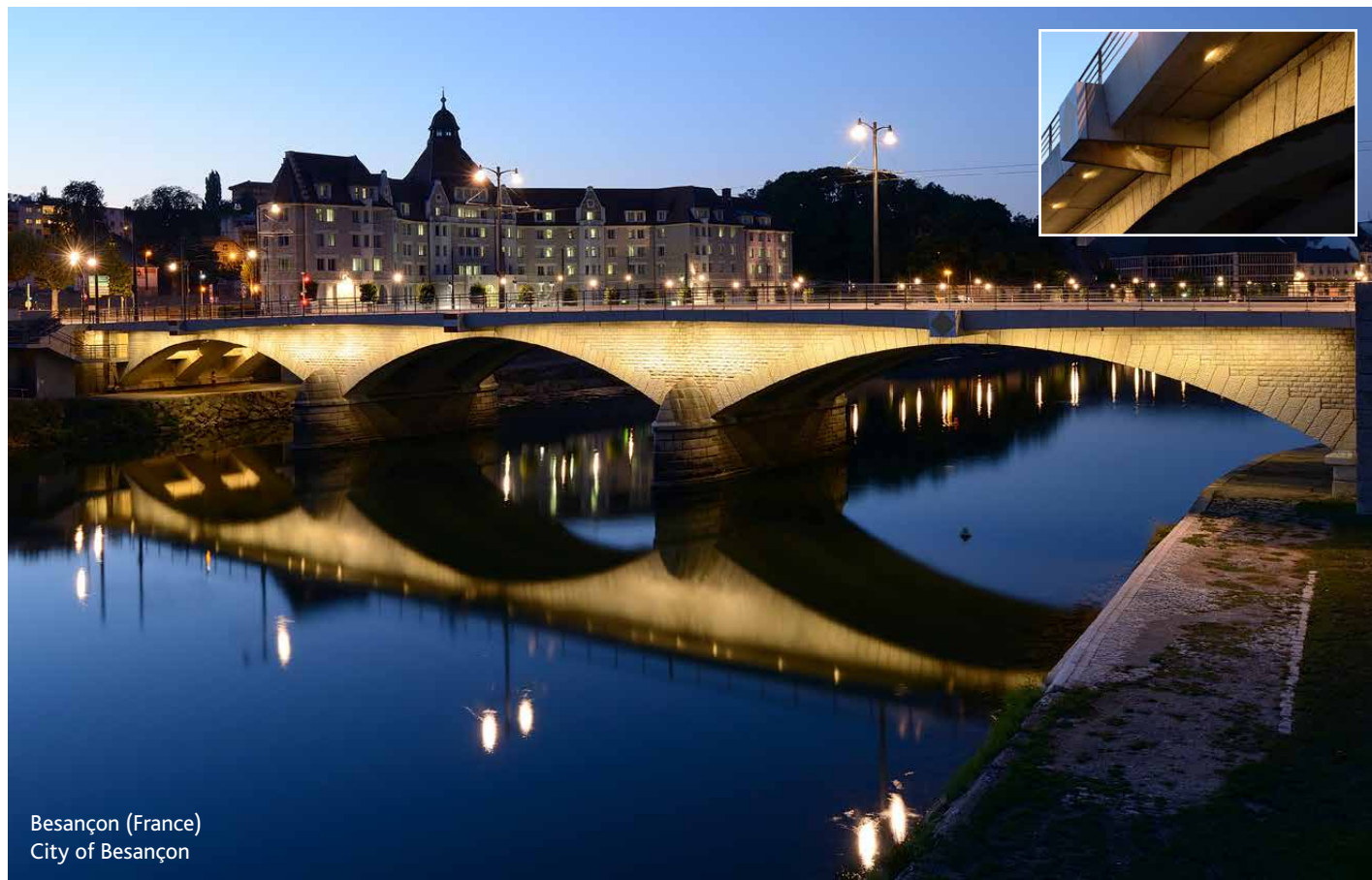
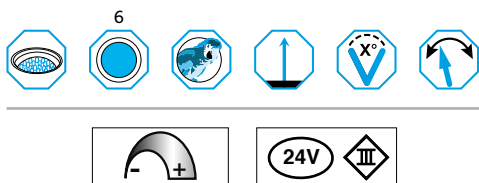
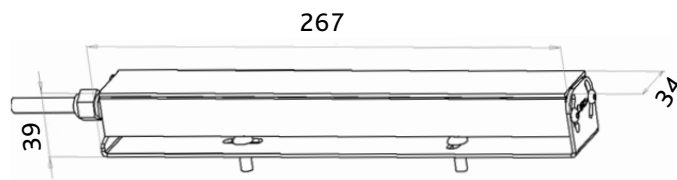

Besançon (France)
City of Besançon

5634

Stripe

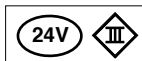
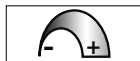
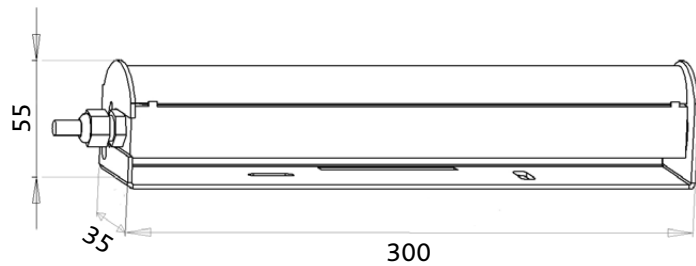
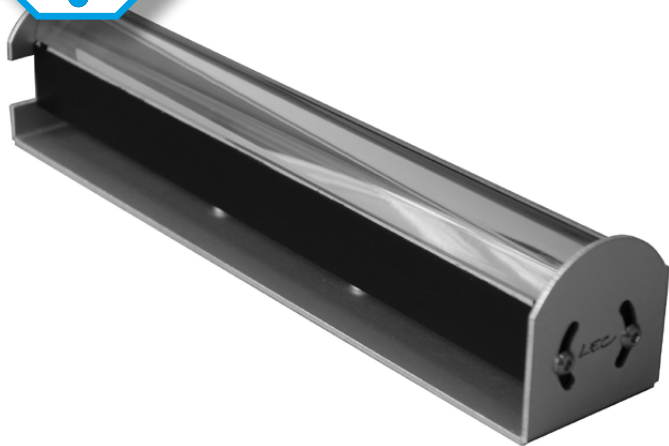

Grenade (France)
ECLAR

5635

Ligny

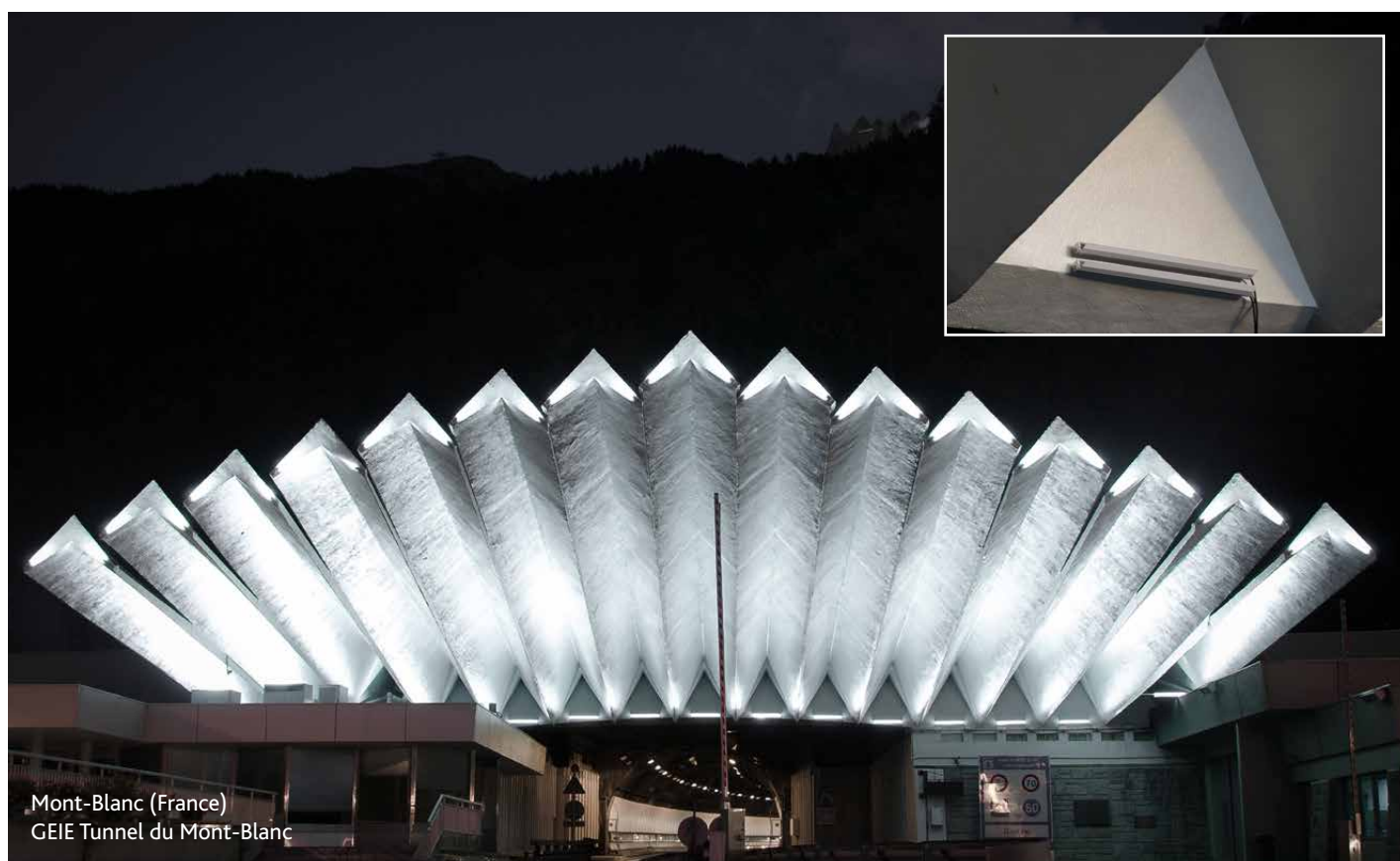
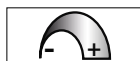
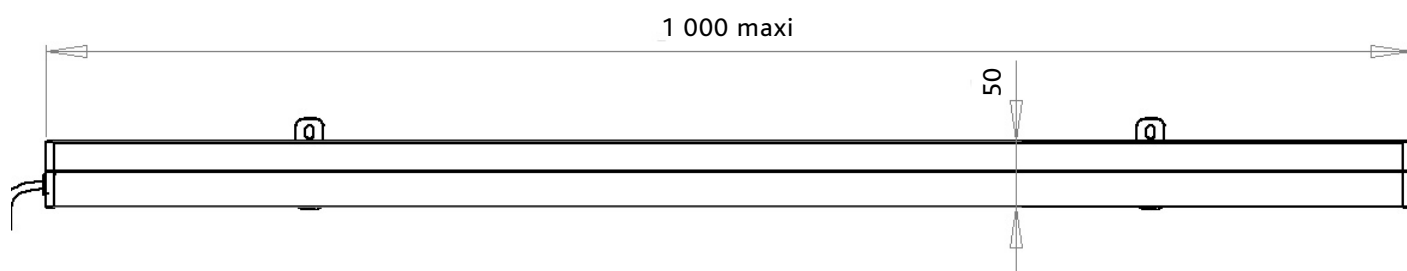

Mont-Blanc (France)
GEIE Tunnel du Mont-Blanc

5636

Lima



NEW

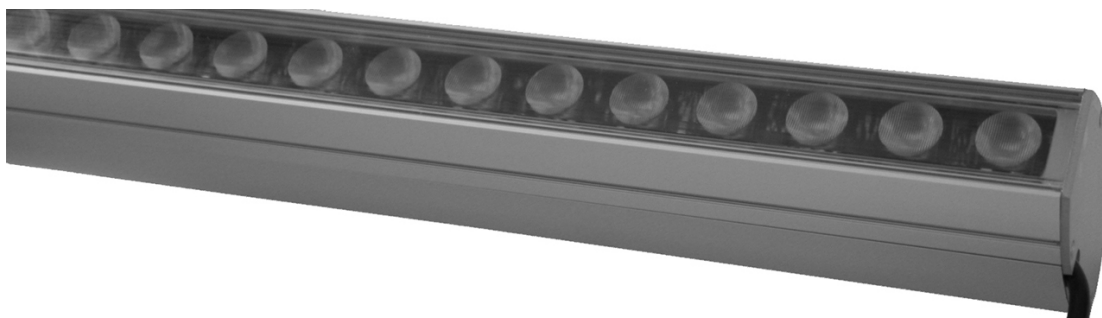

1 000 maxi

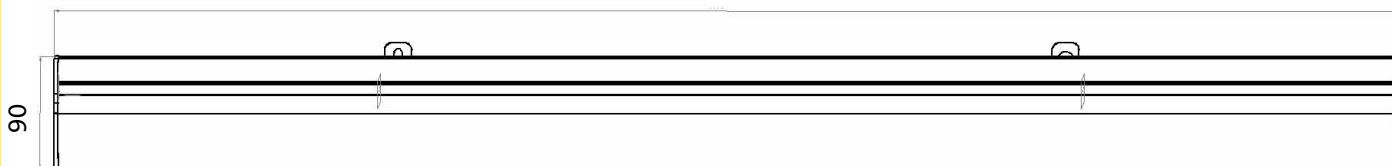

Mont-Blanc (France)
GEIE Tunnel du Mont-Blanc

5640 School-light

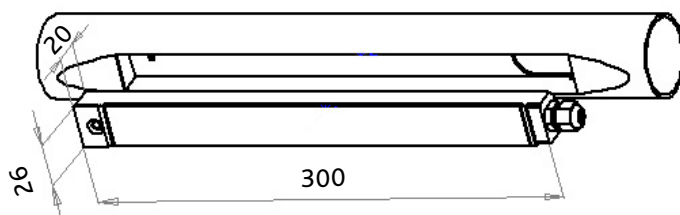

5640 + 5682 V1

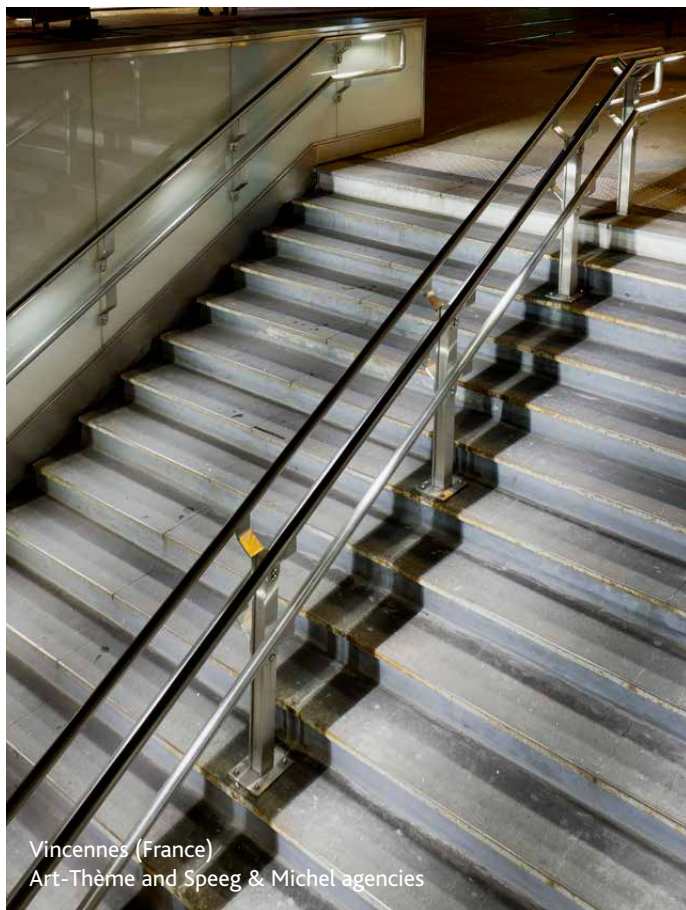
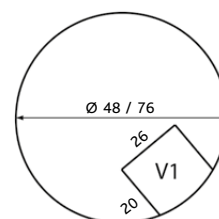

Vincennes (France)
Art-Thème and Speeg & Michel agencies



Caluire Montessuy (France)
Les Eclairagistes Associés

5642

Button A



5643

Button B



04/2017

NEW

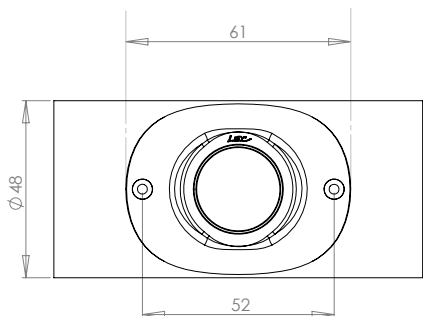

316L



02/2017

NEW

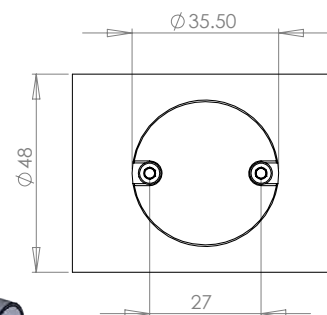
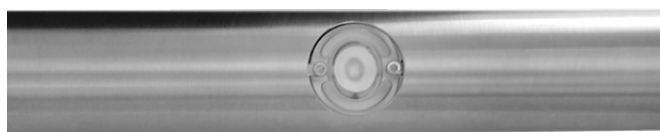

Al

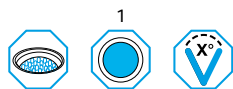

PC 2

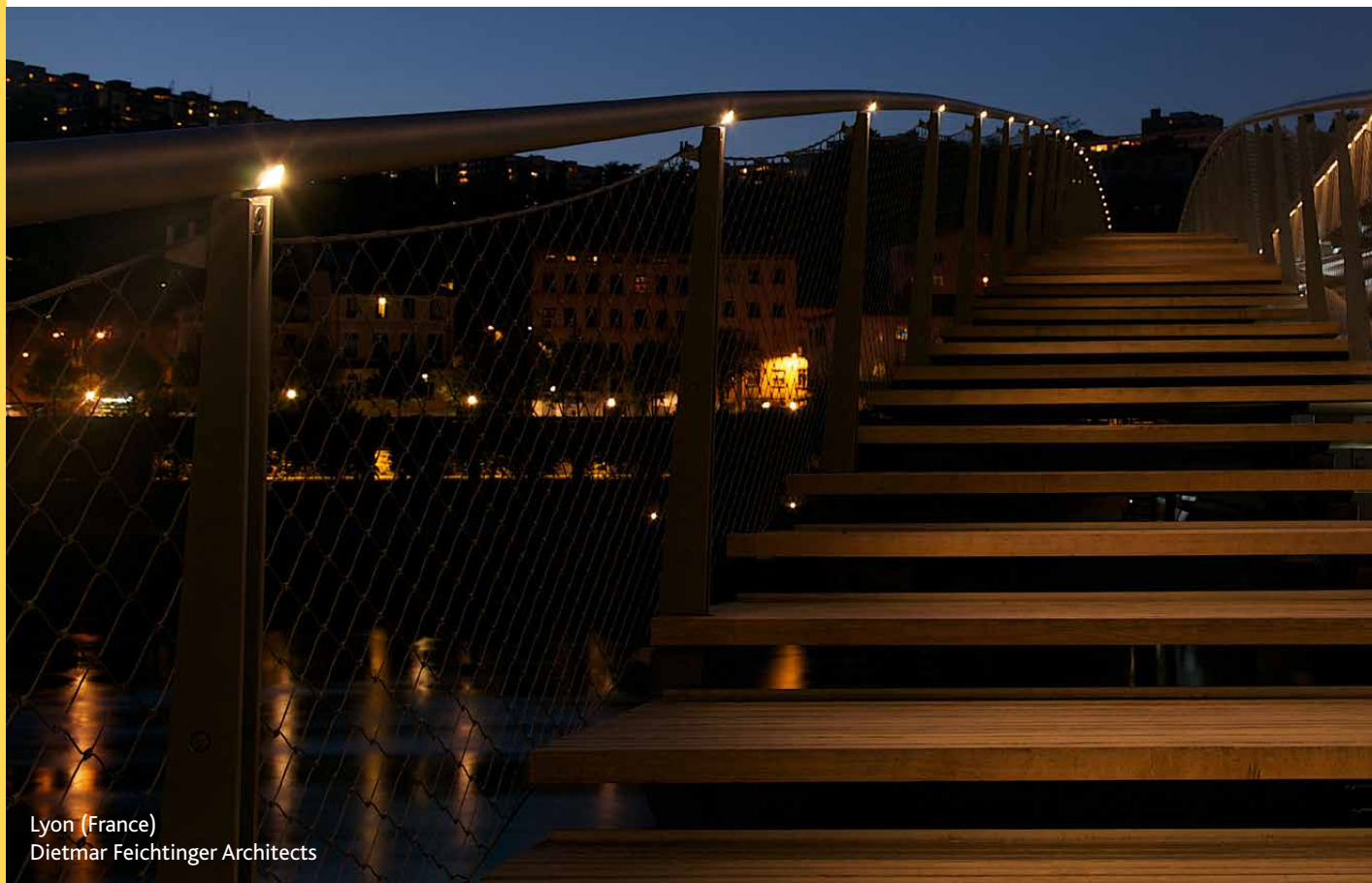

Lyon (France)
Dietmar Feichtinger Architects

5650

Clem



NEW

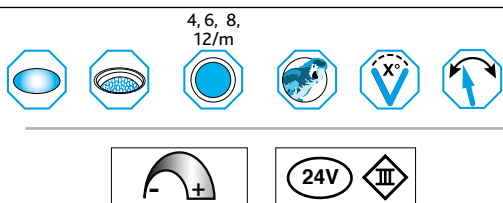
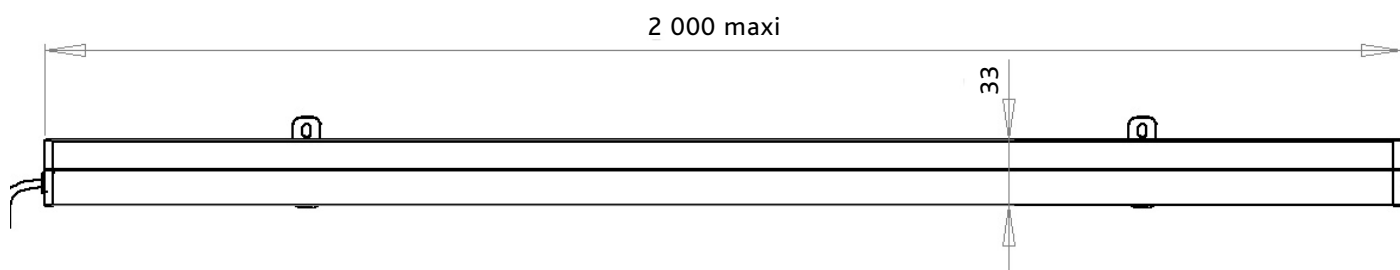
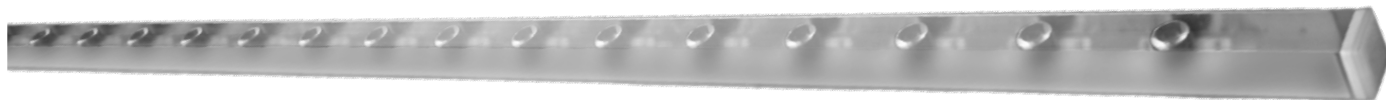

Lyon (France)
Les Eclairagistes Associés



Rennes (France)
Rennes City and Metropolis

5655

Lignon



NEW

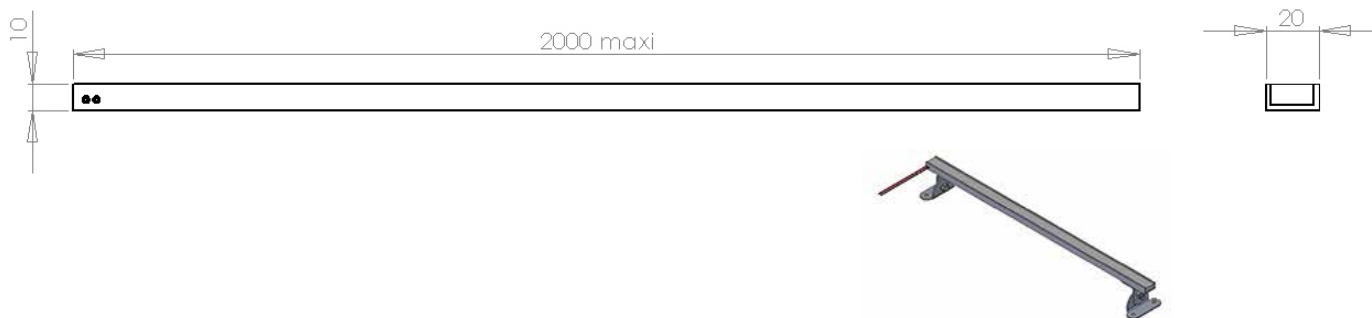

Montpellier (France)
Sylvie SIEG

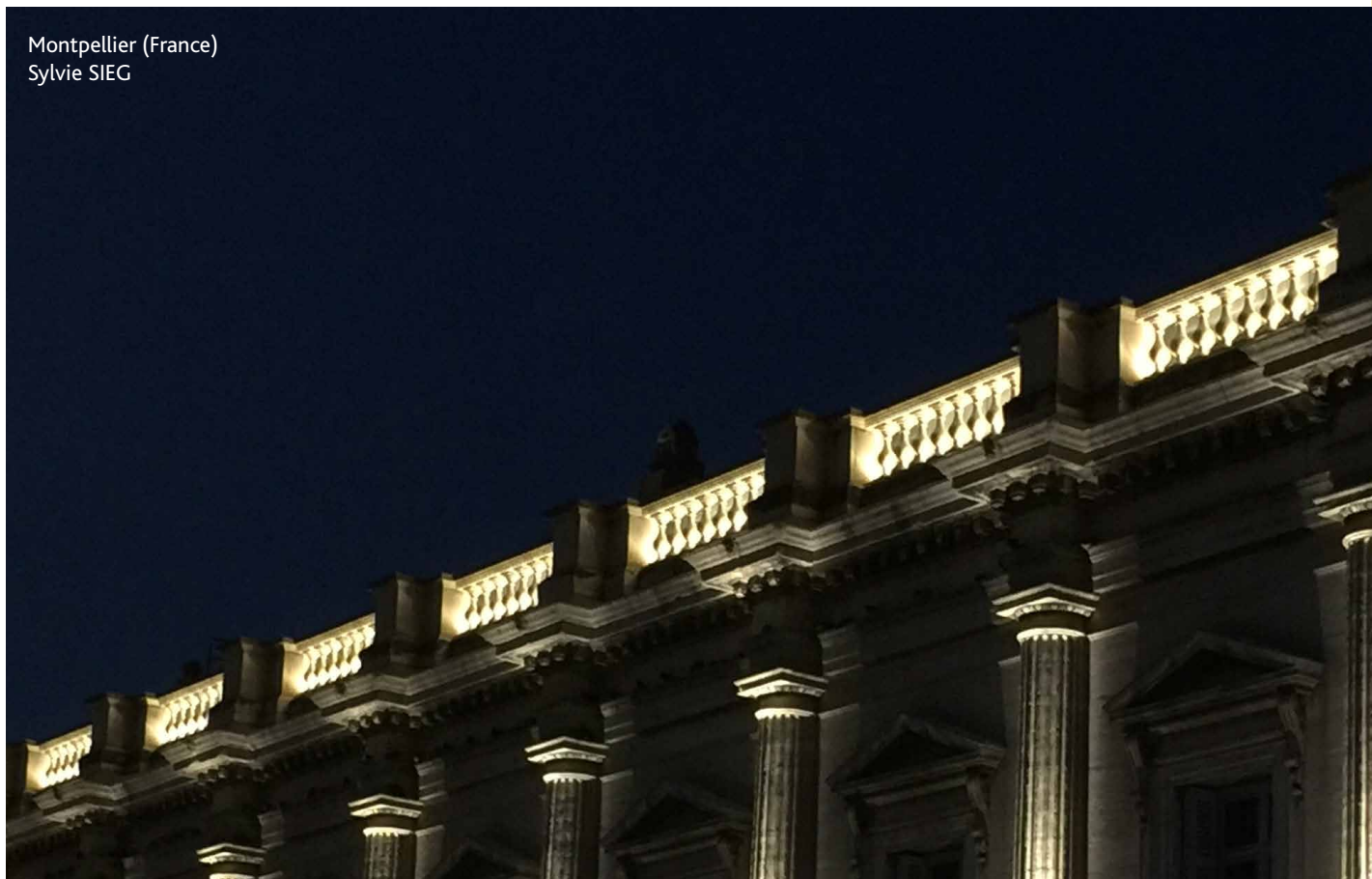

5712

Albi

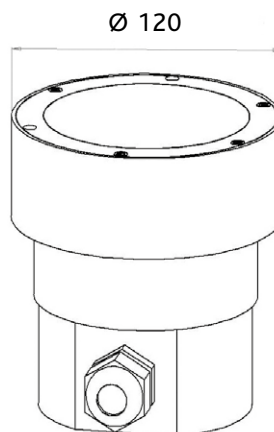

5712+EB

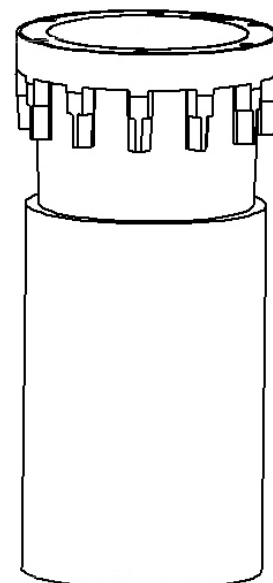

5712+EL

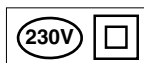
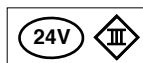
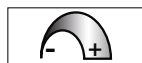

Funchal (Madeira)
Auralight Portugal



5716 Allevard

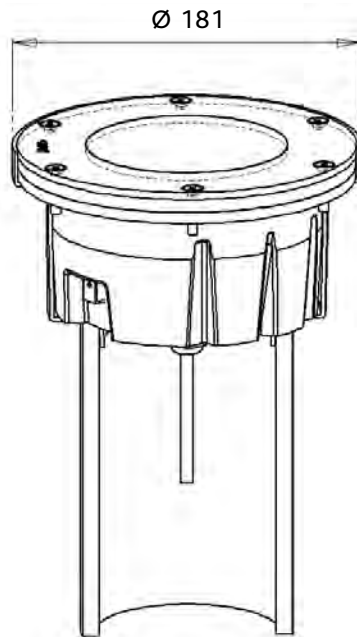

5716+EL

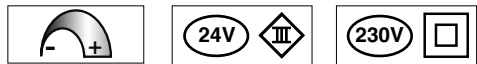

Vernaison (France)
SIGERLY

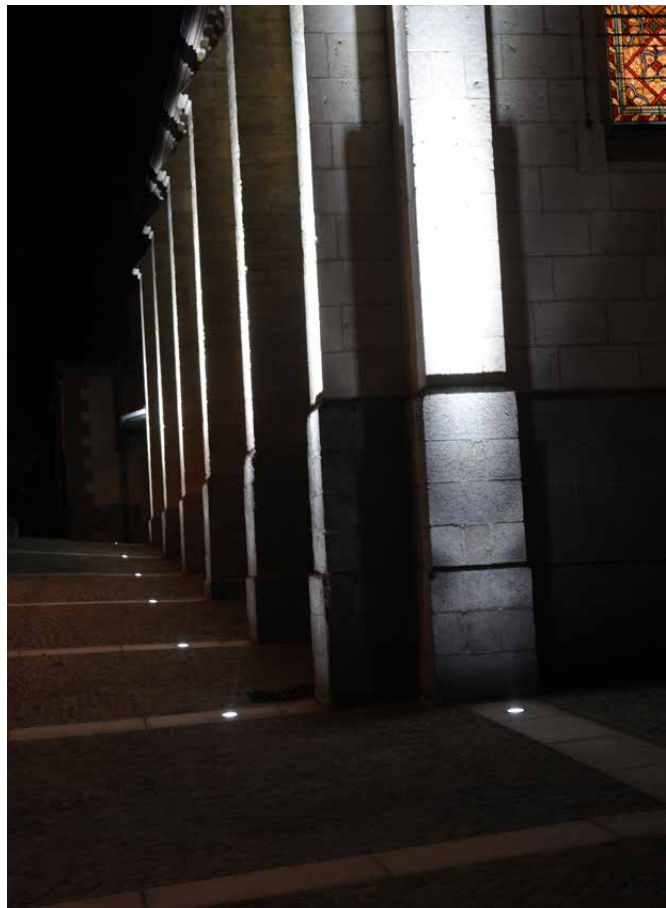

5727 Alicante

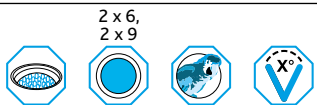
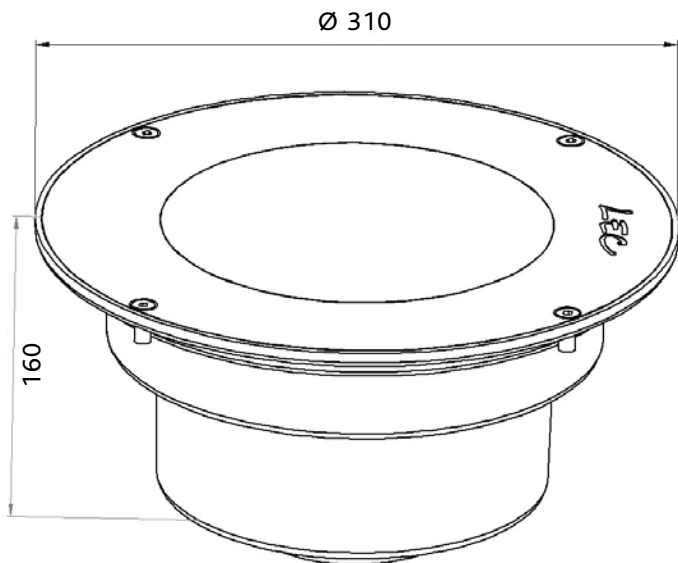

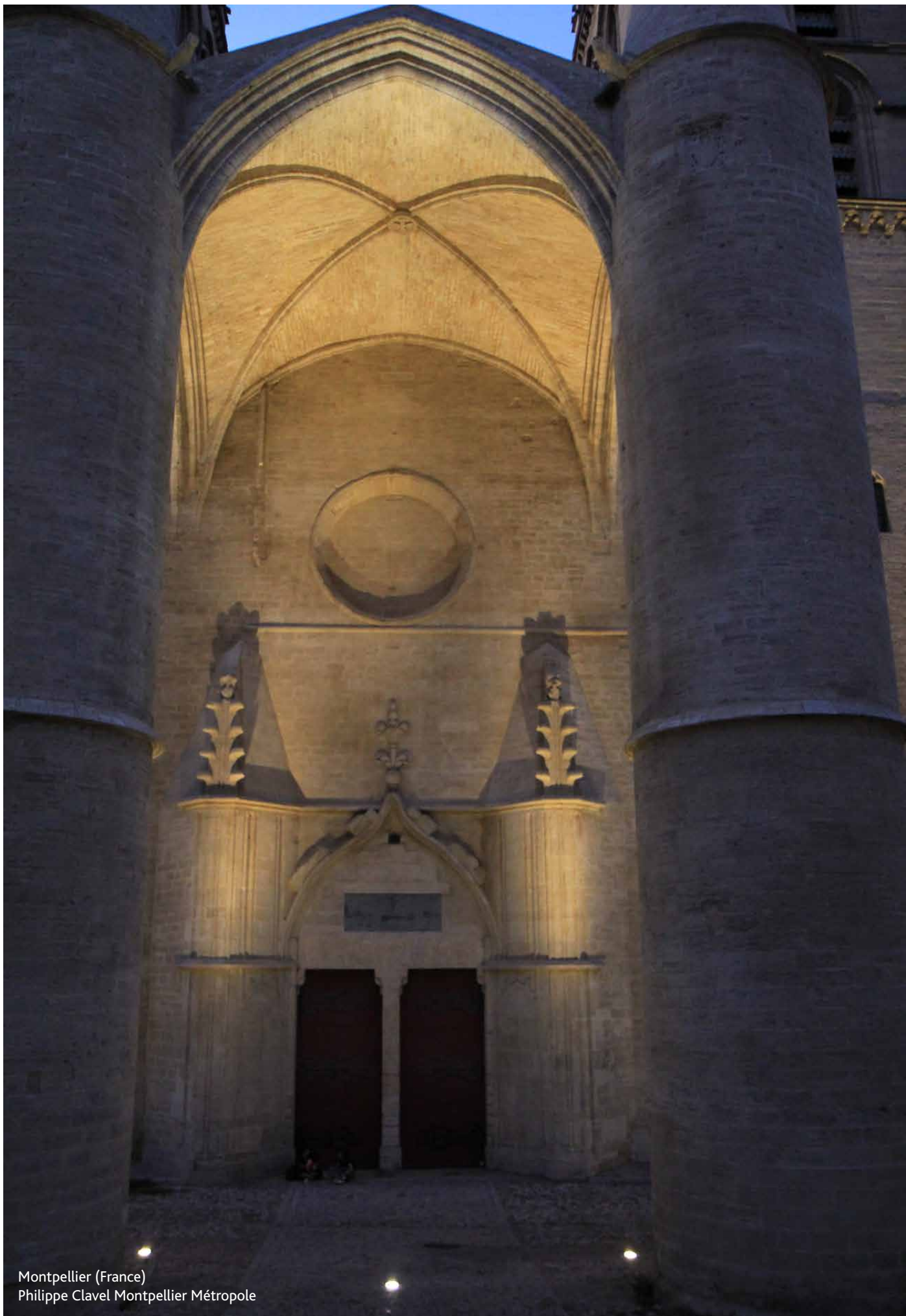

Montpellier (France)
Philippe Clavel Montpellier Métropole

5733

Swindon

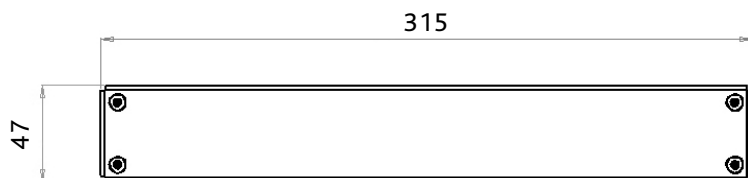

Bassenge (Belgium)
RESA

5760

Passy



260 mini - 1000 maxi

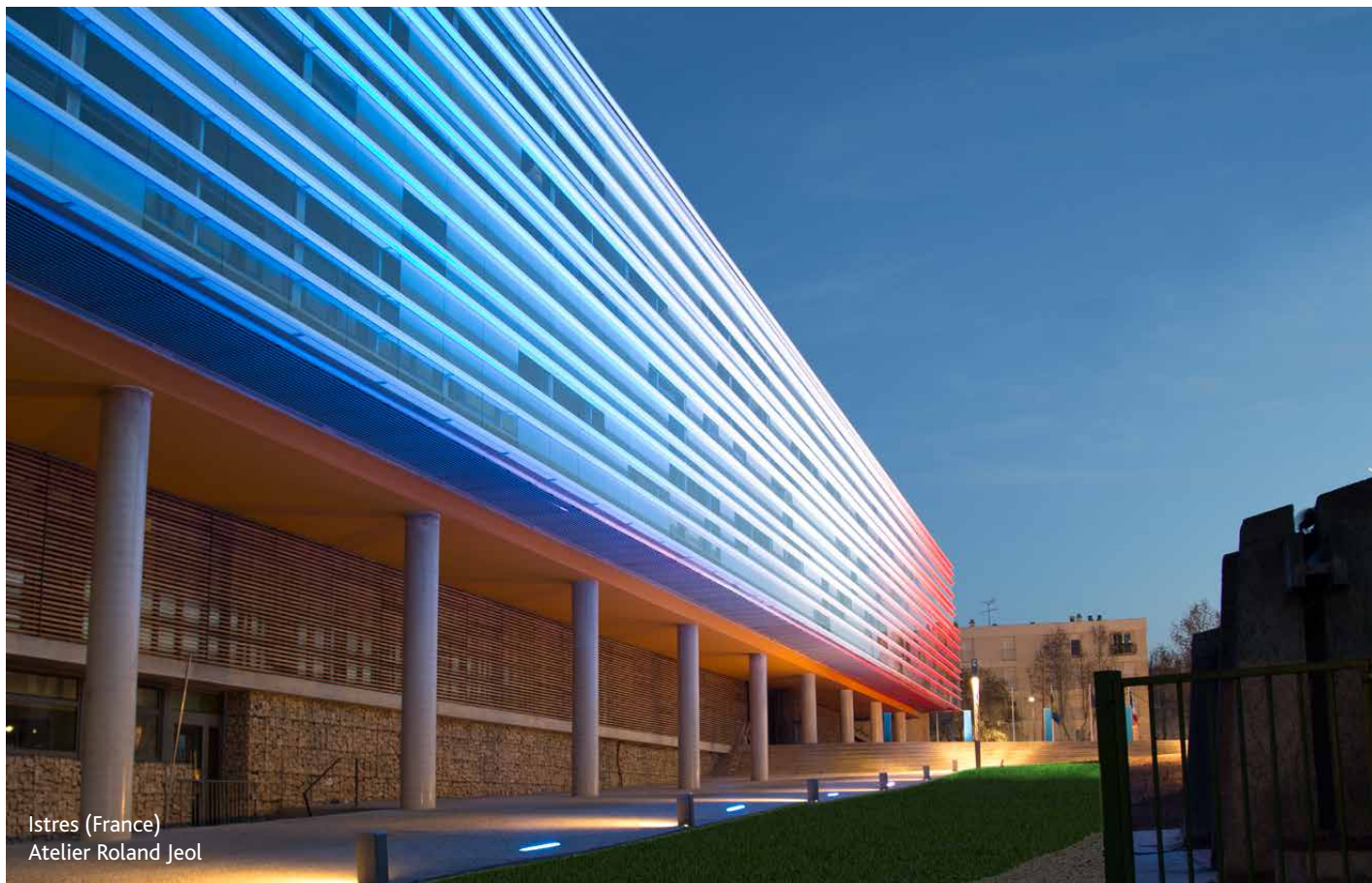
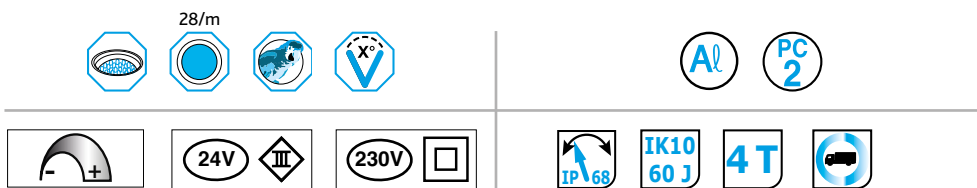
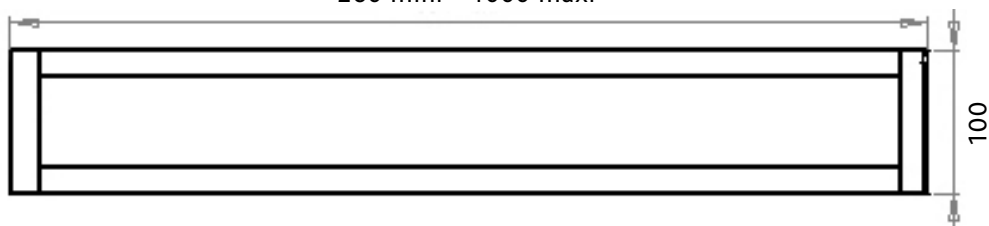

Istres (France)
Atelier Roland Jeol

6060

Brive

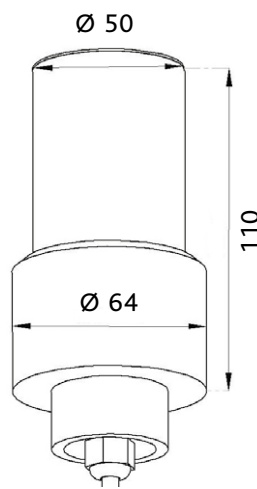

6060

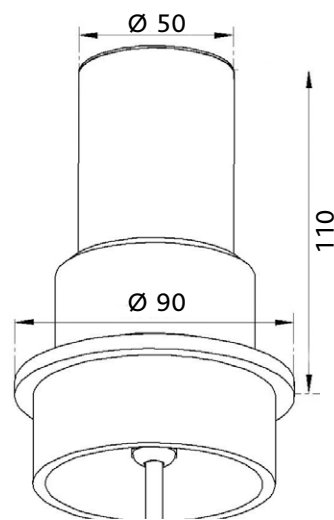

6090

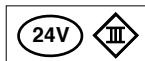
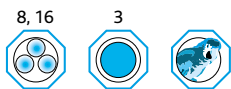

6060 Brive

6060S



Nîmes (France)
M+R Architects

6190

Epernon

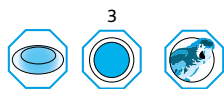
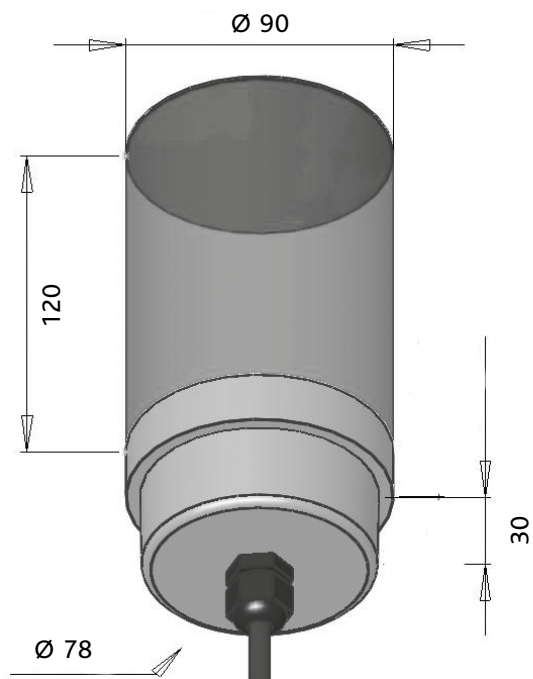

Montpellier (France)
Architecture Studio and Imagine Architects

6406

Boulogne

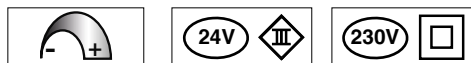
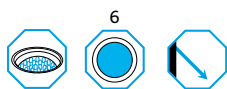
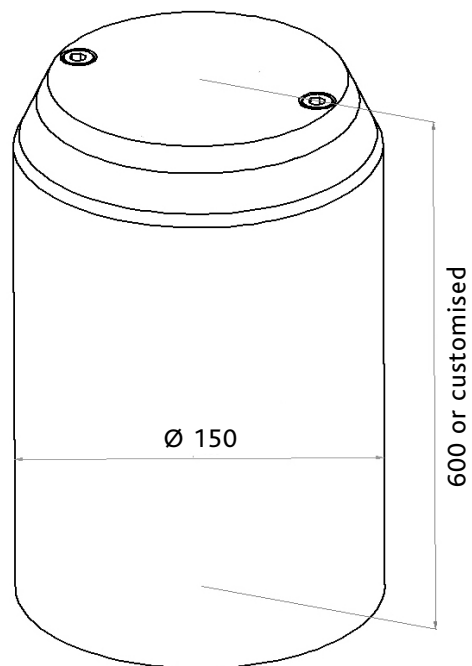

Latour Bas Elne (France)
BE Gaxieu

6430

Parc

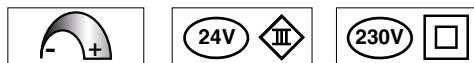
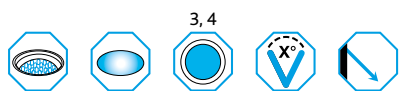
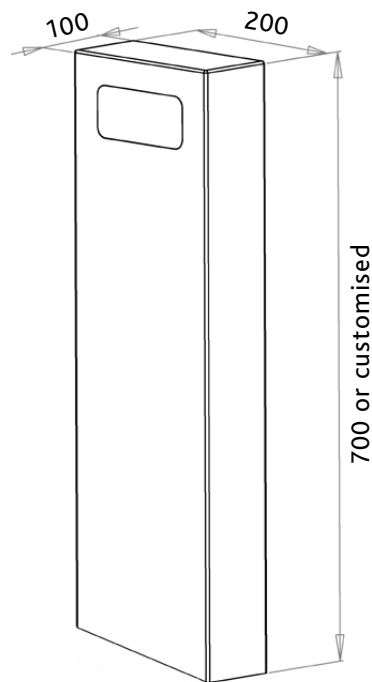

Orléans (France)
City of Orléans

6450

ALLEY



02/2017

NEW

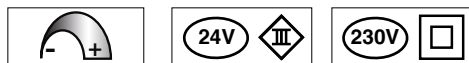
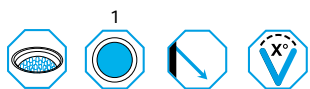
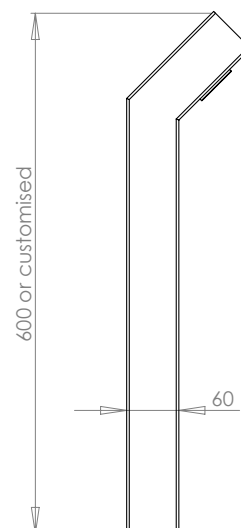
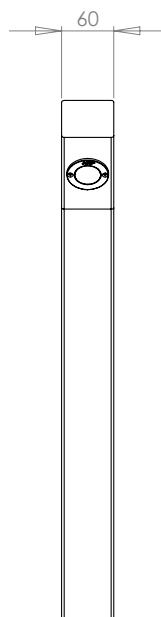

LEC
L y o n

40 / 1977
2017

Produits spéciaux

Bespoke Products

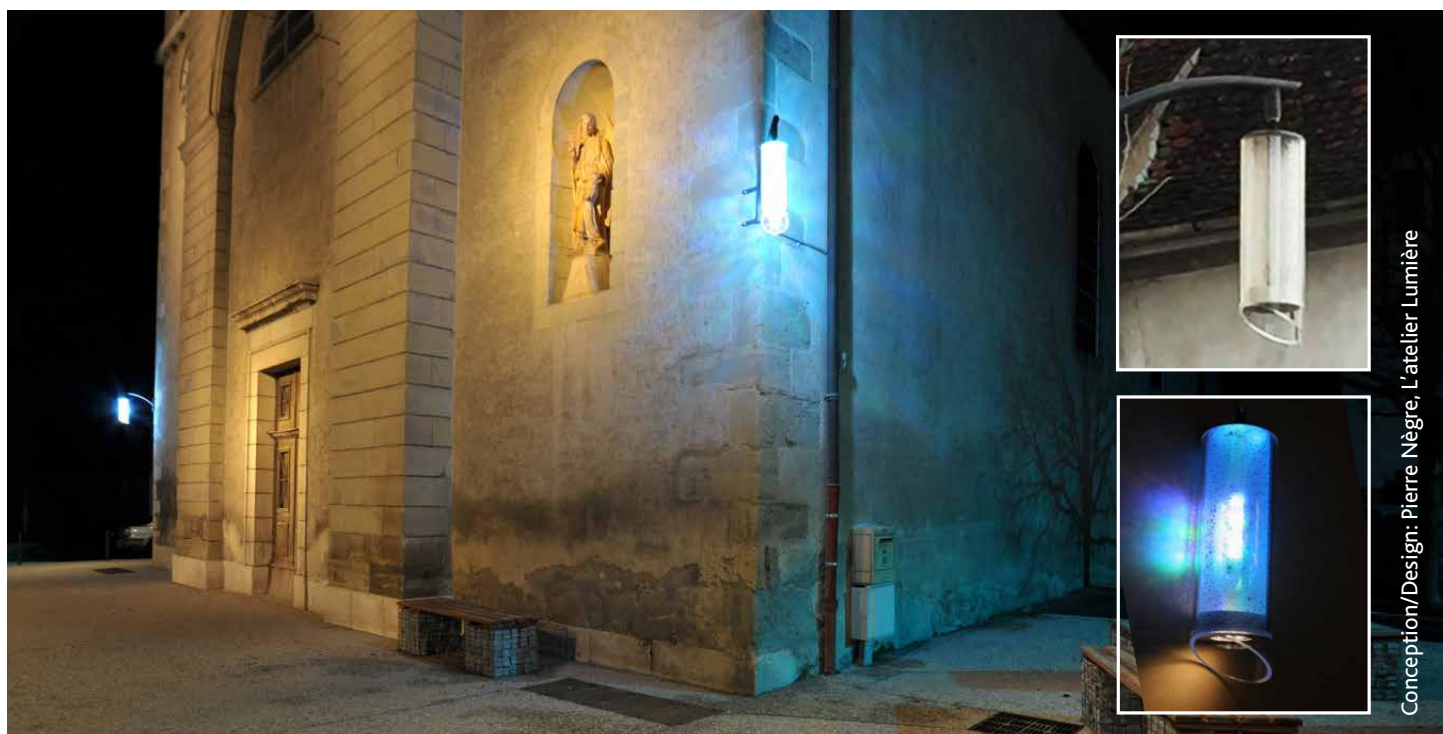

Produits spéciaux

Bespoke Products

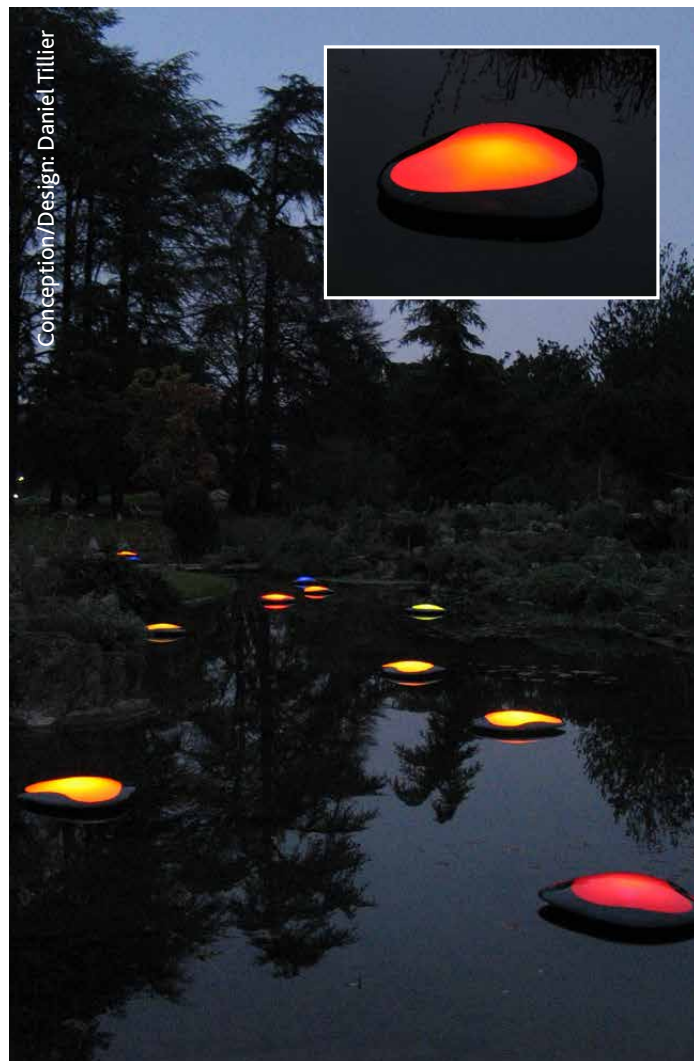

Produits spéciaux

Bespoke Products

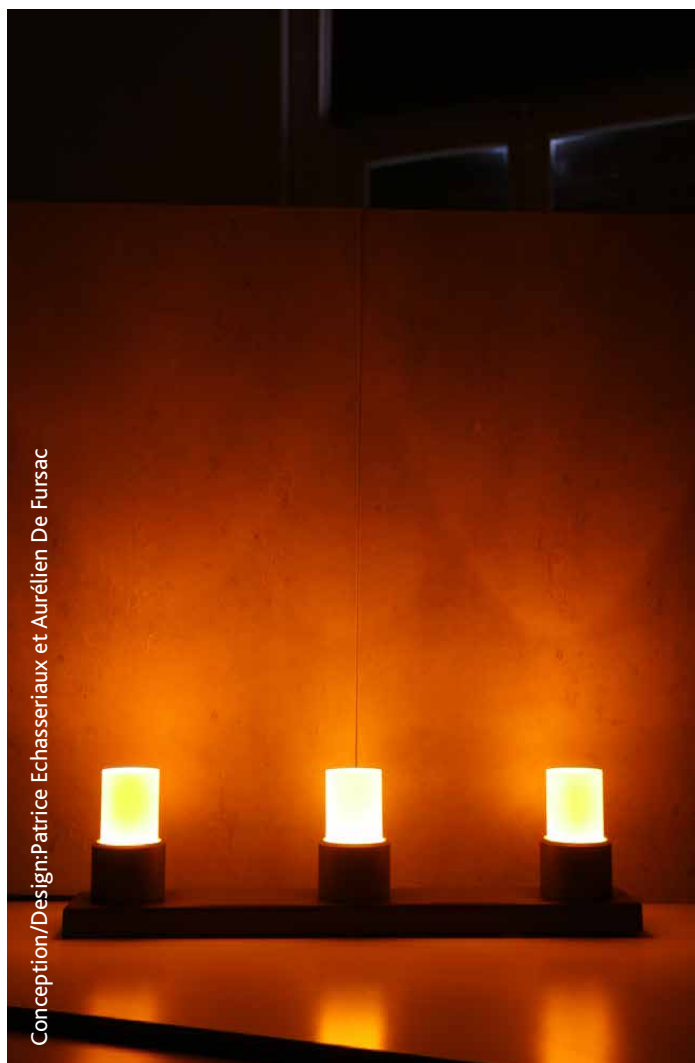

Conception/Design: Patrice Echasseriaux et Aurélien De Fursac

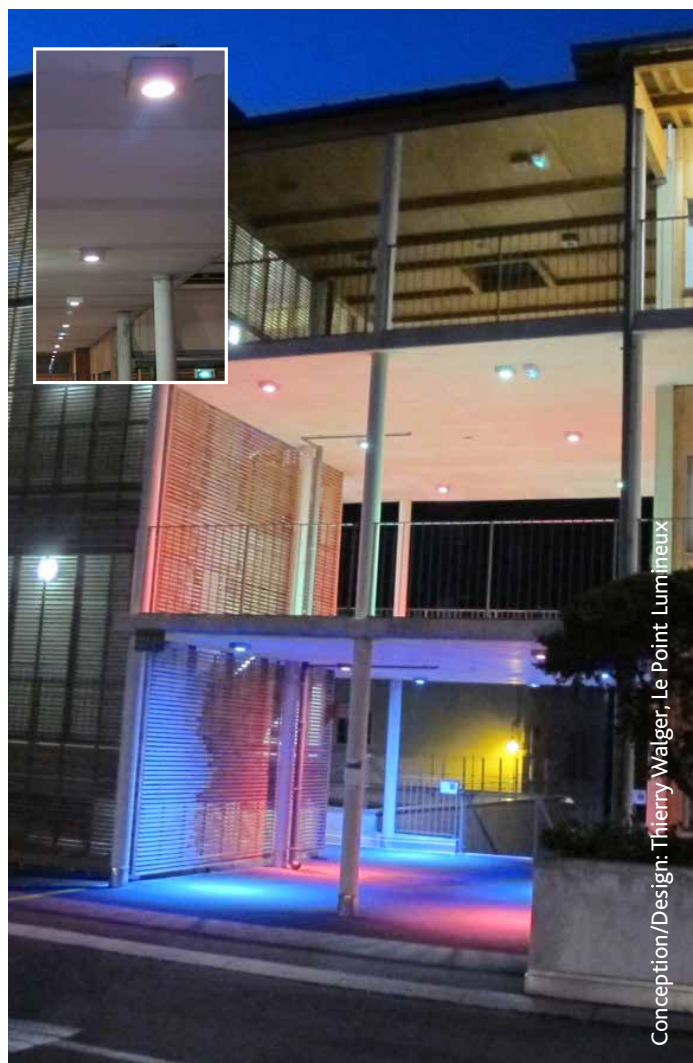

Conception/Design: Thierry Walger, Le Point Lumineux



Conception/Design: Brochet, Lajus & Pueyo Architects, EDP, SIGNIES



Conception/Design: Thierry Walger, Le Point Lumineux

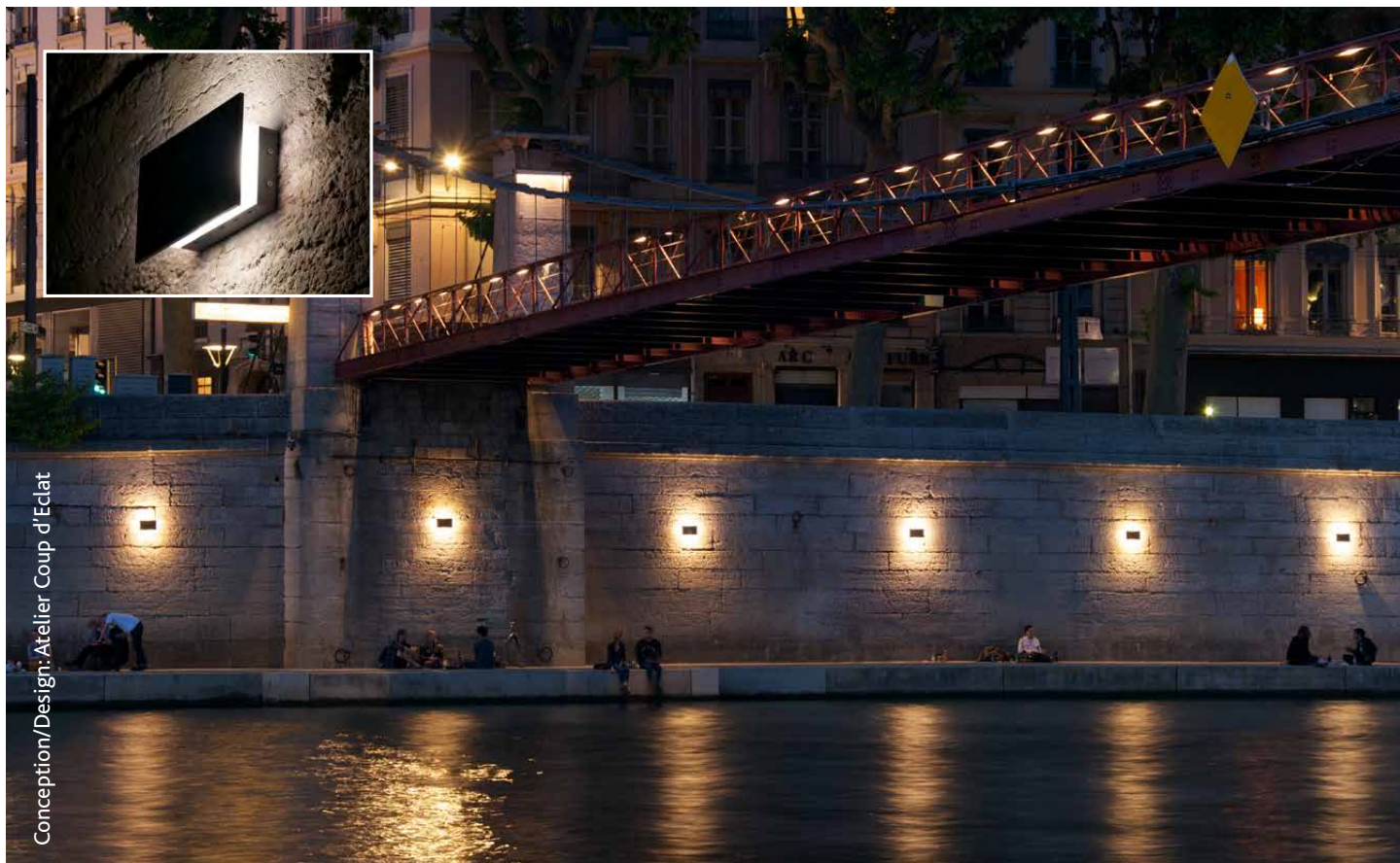

Conception/Design: Atelier Coup d'Éclat

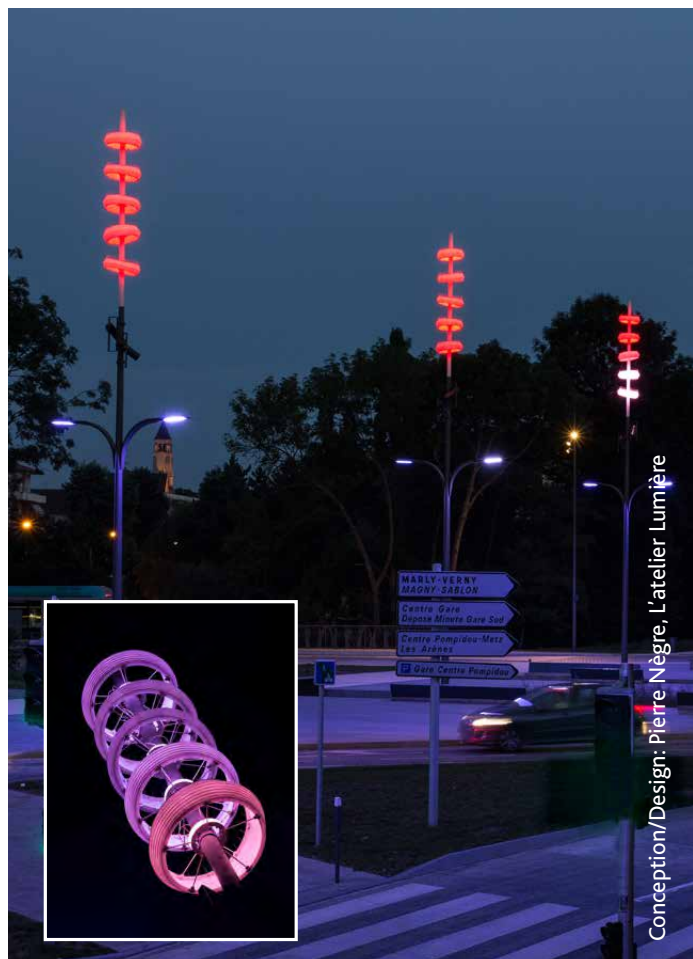
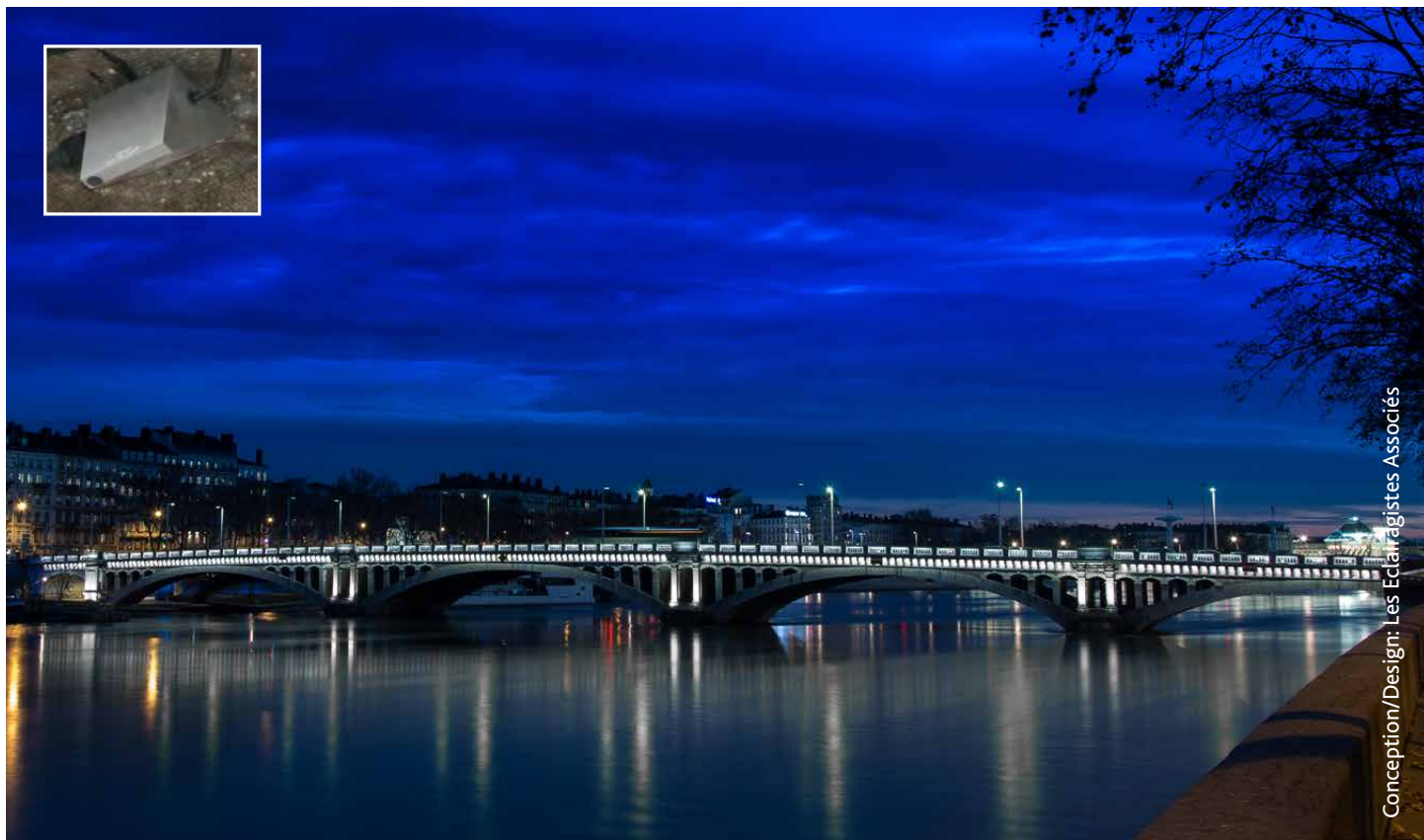



Conception/Design: 8'18"

Obtenez VOS données photométriques .ies

Access YOUR photometric data .ies

FAMILLES

GAMMES

FAMILIES

RANGES

1750 Bourgogne



Ø 50



1750K



Ø 50

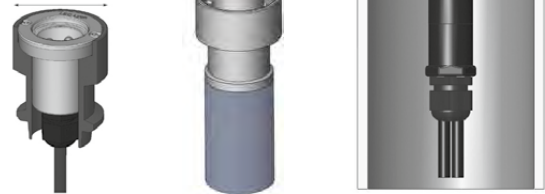

1750+E065

1750+E120

1750+E250

























C1, C2, D, K, PH





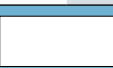

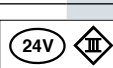















**CARACTÉRISTIQUES
COMMUNES AU PRODUIT
ET AUX OPTIONS**

**COMMON FEATURES
PRODUCT AND OPTIONS**

**CARACTÉRISTIQUES
PROPRES AU PRODUIT**

**PRODUCT SPECIFIC
FEATURES**

	LEGENDE	CAPTION	BESCHREIBUNG	LEGENDA	PIE DE LOS PICTOGRAMAS	LEGENDA
	Domaine	Application	Einsatzfeld	Domanio	Dominio	Domínio
	Eclairage	Lighting	Beleuchtung	Illuminazione	Alumbrado	Iluminação
	Balisage	Marking-light	Sicherheitsbeleuchtung	Marcatura	Balizaje	Marcação
	Effets lumineux	Luminous effects	Lichteffekte	Effetti luminosi	Efectos luminosos	Efeitos luminosos
	Animation couleur	Colour control system	Farbsteuerung	Sistema di controllo del colore	Sistema de control de color	Sistema de controle de cor
	Fenêtre	Window	Fenster	Finestra	Ventana	Janela
	Fenêtre plane transparente	Flat transparent window	Transparentes ebenes Fenster	Finestra piana trasparente	Ventana plana transparente	Janela plana transparente
	Fenêtre plane dépolie	Flat frosted window	Flaches mattes Fenster	Finestra piana opacizzata	Ventana plana deslustrada	Janela plana despolida
	Fenêtre plane homogène	Flat homogeneous window	Flaches homogenes Fenster	Finestra piana omogenea	Ventana plana homogenea	Janela plana homogénea
	Dôme transparent	Transparent dome	Durchsichtige Kalotte	Duomo trasparente	Cúpula transparente	Abóbada transparente
	Dôme diffusant	Frosted dome	Matte Kalotte	Duomo opacizzato	Cúpula deslustrada	Abóbada despolida
	Boule diffusante	Frosted ball	Matte Streukugel	Palla opacizzata	Bola deslustrada	Esfera despolida
	LED	LED	LED	LED	LED	LED
	Nombre de diodes Ø 5 mm	Quantity of Ø 5 mm diodes	Anzahl der Ø 5 mm-Dioden pro Gerät	Quantità di diodi Ø 5 mm	Número de diodos Ø 5 mm	Número de díodos Ø 5 mm
	Nombre de microdiodes	Quantity of microdiodes	Anzahl der Micro-Dioden	Quantità di microdiodi	Número de microdiodos	Número de micro díodos
	Nombre de microdiodes trichromiques	Quantity of trichromic microdiodes	Anzahl trichrometrische Dioden	Quantità di microdiodi tricromatici	Número de microdiodos tricromaticos	Número de micro díodos tricrómicos
	Nombre de diodes Ø 5 mm R+V+B	Quantity of Ø 5 mm diodes R+G+B	Anzahl der RGB Dioden	Quantità di diodi Ø 5 mm R+G+B	Número de diodos Ø 5 mm R+G+B	Número de diodos Ø 5 mm R+V+B
	Nombre de diode de puissance	Quantity of Power LED diodes	Anzahl der Leistungsdioden	Quantità di doppio de potenza	Número de diodo de potencia	Número de díodo de potência
	Direction	Beam direction	Lichtstrahlausrichtung	Orientamento	Orientación	Orientação
	Faisceau dévié	Deflected beam	abgelenkter Lichtstrahl	Fascio deviato	Haz desviado	Feixe desviado
	Faisceau parallèle	Paralell beam	Paralleler Lichtstrahl	Fascio parallelo	Haz paralelo	Feixe paralelo
	Faisceau perpendiculaire	Perpendicular beam	Vertikaler Lichtstrahl	Fascio perpendicolare	Haz perpendicular	Feixe perpendicular
	Divers angles d'ouverture du faisceau lumineux	Beam with various opening	Verschiedene Winkel des Lichtstrahls	Diversi angoli di apertura del fascio di luce	Varias aperturas del haz luminoso	Diversos ângulos de abertura do feixe luminoso
	Faisceau orientable	Rotating beam	Verstellbarer Lichtstrahl	Orientabile	Haz orientable	Feixe orientável
	Alimentation - Electricité	Power supply - Electricity	Verbrauch – Strom	Alimentazione - Elettricità	Alimentación - Electricidad	Alimentação - Eletricidade
	Dimmable (en 24 VDC)	Dimmable (with 24 VDC)	Dimmbar (in 24 VDC)	Dimmer possibile (con 24 V)	Dimmer posible (con 24 VDC)	Obscurecido (a 24 VDC)
	24 V Classe 3	24 V Class 3	24 V Klasse 3	24 V classe 3	24 V Clase III	24 V classe 3
	230 V Classe 2	230 V Class 2	230 V Klasse 2	230 V classe 2	230 V Clase II	250 V classe 2

	LEGENDE	CAPTION	BESCHREIBUNG	LEGENDA	PIE DE LOS PICTOGRAMAS	LEGENDA
	Matériaux	Material	Material	Materiali	Materiales	Materiais
	Fonte d'aluminium	Cast aluminum	Aluminiumguss	Ghisa d'alluminio	Fundición de aluminio	Liga de alumínio
	Aluminium anodisé satiné	Anodised glazed aluminium	Aluminium eloxiert seidenmatt	Alluminio anodizzato satinato	Aluminio anodizado satinado	Alumínio anodizado acetinado
	Inox	Stainless steel	Edelstahl	Acciaio inossidabile	Acero inoxidable	Inóx
	Inox	Stainless steel	Edelstahl	Acciaio inossidabile	Acero inoxidable	Inóx
	Résine composite	Composite resin	Zweikomponenten Harz	Resina composita	Resina compuesta	Resina compósita
	Fenêtre polycarbonate, anti-vandalisme, anti-U.V.	Vandal-proof, anti-U.V. polycarbonate window	Polycarbonatfenster, Vandalismus und UV resistant	Finestra policarbonato, antivandalismo, antiraggi-U.V.	Ventana de polycarbonato antivandalismo, anti-U.V.	Difusor em policarbonato, anti-vandalismo, anti-UV
	Fenêtre polycarbonate, anti-vandalisme, anti-U.V., anti-rayures, M2	Vandal-proof, anti-scratch, anti-U.V., M2, polycarbonate window	Polycarbonatfenster, Vandalismus und resistant, kratzfest, M2	Finestra policarbonato, antivandalismo, antiraggi-U.V., anti-scalfittura, M2	Ventana de polycarbonato antivandalismo, anti U.V., antirayaduras, M2	Difusor em policarbonato, anti-vandalismo, anti-UV, anti-risco, M2
	Verre organique anti-vandalisme	Vandal-proof organic glass	Organisches Glas, Vandalismus resistant	Vetro organico antivandalismo	Vidrio orgánico antivandalismo	Vidro orgânico anti-vandalismo
	Acier galvanisé thermolaqué	Thermo-lacquered galvanised steel	Thermolackierter galvanisierter Stahl	Acciaio galvanizzato termolaccato	Acero galvanizado revestido	Aço galvanizado revestido
	ECO design	ECO design	ECO design	ECO design	ECO design	ECO design
	Tenues mécaniques - Étanchéité	Mechanical strength - Waterproofness	Schlagfestigkeit - Dichtheit	Tenute meccaniche - Sigillatura	Propiedades mecánicas - Impermeabilidad	Caraterísticas mecánicas - Estanquicidade
	Faisceau orientable Indice de protection 67	Revolving beam Water tightness factor 67	Verstellbarer Lichtstrahl Schutzfaktor 67	Orientabile Indizio di protezione 67	Haz orientable Indicio de protección 67	Feixe orientável Índice de protecção 67
	Indice de protection	Water tightness factor	Schutzfaktor	Indizio di protezione	Indicio de protección	Índice de protecção
	Double étanchéité	Double water tightness	Doppelte Dichtungsebene	Doppia impermeabilità	Doble estanquidad	Dupla estanquidade
	Résistant aux chocs de 20 joules (IK10)	Resists impacts up to 20 joules (IK10)	Hält Stößen von 20 Joule stand (IK10)	Resistente agli urti di 20 joules (IK10)	Resistente a los golpes de 20 J (IK10)	Resistente aos choque 20 joules (IK10)
	Résistant à la compression de 8 tonnes	Resists compression up to 8 tons	Hält einem Druck stand von 8 Tonnen	Resistente alla compressione di 8 tonnellate	Resistente a la compresión de 8 toneladas	Resistente a uma compressão de 8 toneladas
	Certifié conforme à la norme européenne 60598-2-22 sur les luminaires pour éclairage de secours	Certified in compliance with European Standards 60598-2-22 for emergency lighting units	Entspricht der europäischen Norm 60598-2-22 für Beleuchtungskörper von Notbeleuchtungen	Certificato conforme alla normativa europea 60598-2-22 sugli apparecchi di illuminazione per la segnaletica di emergenza	Cumple con la norma europea 60598-2-22, para los aparatos de iluminación de emergencia	Certificado conforme à norma europeia 60598-2-22 sobre os aparelhos de iluminação de emergência
	Saillie représentant un obstacle aux 2 roues ou aux piétons. Nous recommandons de l'allumer en permanence pour signaler l'obstacle.	Protrusion which is an obstacle for 2-wheels and pedestrians. The unit should be permanently lit to draw attention.	Vorsprung der ein Hindernis für Zweiräder und Fußgänger darstellt. Wir empfehlen Dauerbeleuchtung, um auf das Hindernis hinzuweisen.	Sporgenza rappresentante un ostacolo per le due ruote o i pedoni. Se ne raccomanda l'accensione continua per segnalarlo.	Saliente que representa un obstáculo para las 2 ruedas o para los peatones. Recomendamos iluminarlo permanentemente para señalarlo.	Desnível representando um obstáculo para os veículos de 2 rodas ou para os peões. Recomendamos que permaneça continuamente aceso para assinalar o obstáculo.
	Supporte le roulage des 2 roues	Withstands 2-wheels traffic	Hält dem Überfahren durch Zweiräder stand	Sopporta il passaggio delle due ruote	Resistente a la circulación de 2 ruedas	Aguenta a rodagem de veículos de 2 rodas
	Supporte le roulage de véhicules légers à faible vitesse	Withstands low-speed light vehicle traffic	Hält dem Überfahren durch PKW's bei geringer Geschwindigkeit stand	Sopporta il passaggio di veicoli leggeri a bassa velocità	Resistente a la circulación de vehículos ligeros a baja velocidad	Aguenta a rodagem de veículos ligeiros a baixa velocidade
	Supporte le roulage occasionnel tous véhicules	Withstands random all vehicle traffic	Hält dem gelegentlichen Überfahren durch alle Fahrzeugtypen stand	Sopporta il passaggio occasionale di tutti i veicoli	Resistente a la circulación ocasional de todos vehículos	Suporta a rodagem ocasional de todos os veículos
	Supporte le roulage de tous véhicules	Withstands all vehicle traffic	Hält dem Überfahren durch alle Fahrzeugtypen stand	Sopporta il passaggio di tutti i veicoli	Resistente a la circulación de todos los vehículos	Aguenta a rodagem de todos os veículos

LEC

Ly on

40¹⁹⁷⁷
/2017



NOUVELLE ADRESSE : LEC LYON, 24 avenue Joannès Masset, 69009 Lyon

☎ : +33 (0) 437 480 409 - @ : com@lec.fr

www.lec.fr