



CLASSE 300



THE **CONNECTED**
VIDEO INTERNAL UNIT





The **CLASSE 300X13E** video internal unit allows you to transform every home into a connected home, which can be easily controlled in the home and at a distance using a smartphone.



Eliot is the BTicino program dedicated to connected objects (Internet of things) which identifies all those products or systems which, because they can connect to the Cloud, give added value in terms of functionality, information, interactions with the environment and use.

Contents

4-20			
CLASSE 300X13E	Modern, connected, simple		4
	What can you do with CLASSE 300X13E?		6
	The advantages		10
	Door Entry App – Designed for the final user		12
	Immediately connected and configured		14
	Connected and Interoperable		16
	Perfect to replace your old 2 wires internal unit		20
22-26			
CLASSE 300	CLASSE 300 - A stylish choice		22
range	A simple approach to everyday gestures		26
General			
features			
28-31			
CLASSE 300	Features and functions		28
range	Catalogue and Dimensional data		30
Catalogue	Legal notes		31

CLASSE 300X13E

The pictures shown on the display are exclusively for illustrational and promotional purposes.



MODERN
CONNECTED
SIMPLE

The facility of BTicino 2 wires technology with the advantage of the connection for more functions and extra services

CLASSE 300X13E is the connected video internal unit which combines modernity and innovation thanks to the communication between smartphone and video internal unit. The integrated Wi-Fi connectivity allows the connection (*) with your

smartphone and, thanks to the dedicated App, you can manage the video door entry calls in an innovative and functional way. Featuring a wide 7" Touch Screen display, it is ideal for all clients who care about technology and innovation, thanks to its unique design.



Always in contact with your home.

The possibility of managing the different functions using a smartphone is added to the installation simplicity offered by the CLASSE 300X13E. Both inside and outside the home you will be able to manage calls, answering machine, open the gate, activate the camera or operate the timed garden lights... Everything with a simple touch.

NOTE (*): for the connection you need a home Wi-Fi network with Internet access.
See LEGAL NOTES section on page 31.



ANSWER COMFORTABLY FROM YOUR HOME SOFA

Absolute freedom of movement inside your home. You can answer the video door entry call from any room of your home.

WHAT CAN YOU DO WITH CLASSE 300 X13E?



Hi Anna, come in, I'll open the door immediately!

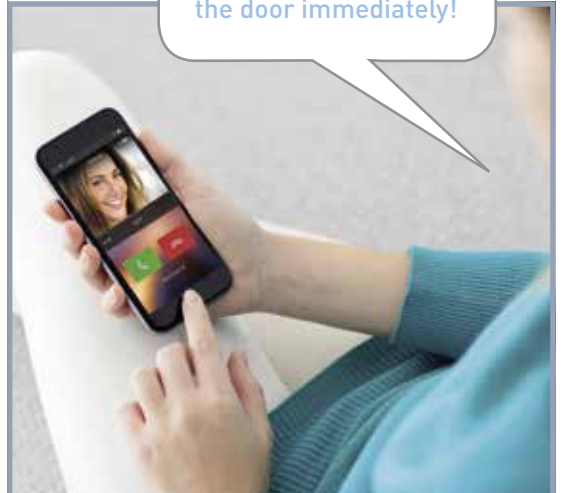

It is possible to manage various functions using the (free) App for Android and iOS smartphone

ANSWER THE CALL WHEN YOU ARE OUT OF YOUR HOME

When you are out, on holiday, in the office, you can answer the video door entry call wherever you are.

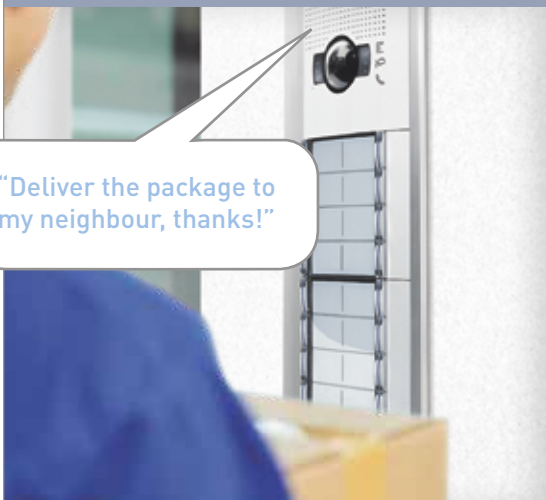

“Deliver the package to my neighbour, thanks!”

ACTIVATE, DEACTIVATE AND ACCESS THE VIDEO DOOR ENTRY ANSWERING MACHINE MESSAGES

Before going out, if you don't want to miss a call, switch on your video door entry answering system. Your smartphone always lets you know who is looking for you.

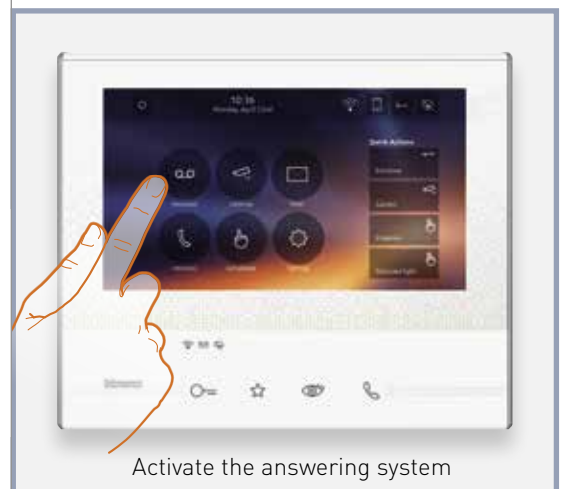

Activate the answering system



NOTE: using the smartphone it is possible to activate and deactivate the video door entry answering machine and access the previous messages.

WHAT CAN YOU DO WITH CLASSE 300X13E?

CALL HOME DIRECTLY

Always keep in touch with anyone at home. The smartphone is an intercommunicating terminal with your video internal unit.

Hi Anna, can you see if my purse is in the living room?

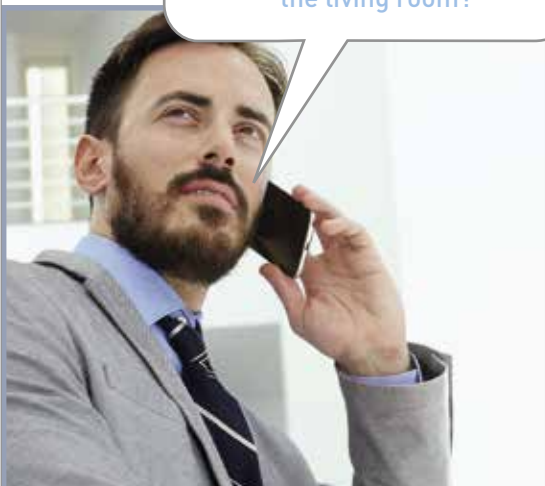

OPEN THE HOME GATE WHEN YOU DO NOT HAVE YOUR RADIO CONTROL

You return home by car and cannot find your gate radio control? No problem, you can open the gate with your smartphone.



NOTE: all the door locks connected to your 2 wires video door entry system can be controlled by smartphone.

SEE WHAT IS HAPPENING AT HOME

More security for your home. Using your smartphone you can activate the external and internal cameras connected to your video door entry system.



NOTE: all the cameras connected to your 2 wires video door entry system can be controlled by smartphone.

SWITCH ON THE LIGHT OR WATER THE GARDEN

Even when you are out or on holiday, you can comfortably activate the garden watering and switch the lights on directly from your smartphone.

... and even the garden is watered!

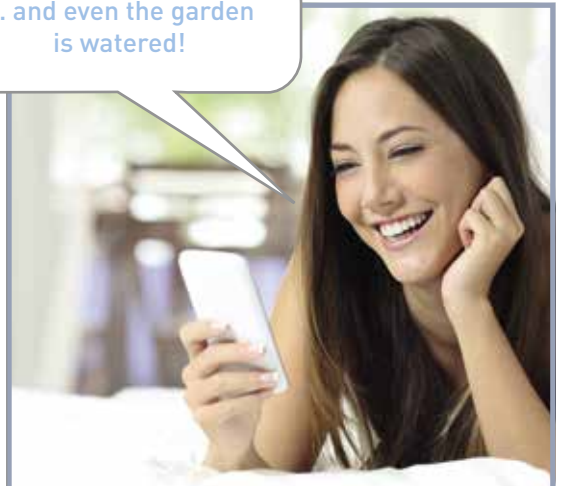

NOTE: the timed actuators connected to your 2 wires video door entry system can be controlled by smartphone.

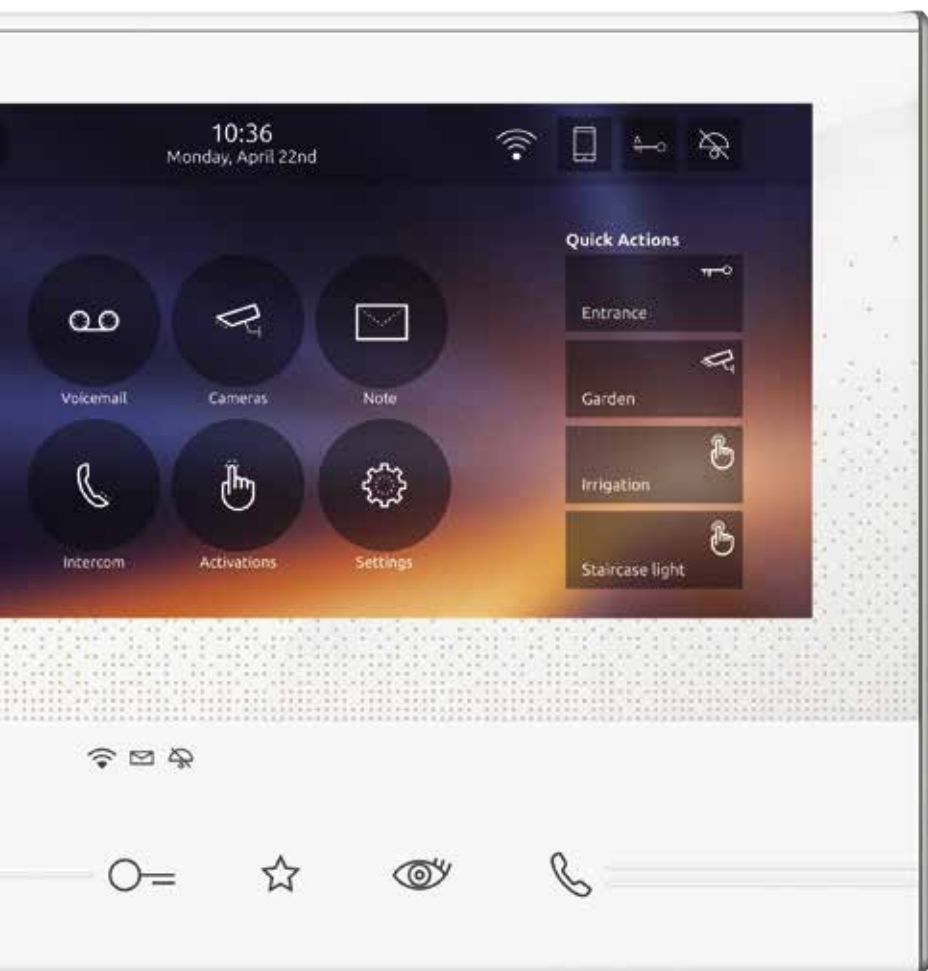

2 wires standard installation

Thanks to the integrated Wi-Fi connectivity, Classe 300X13E does not require work on the walls and follows the **same installation rules** as a "normal" 2 wires video internal unit.



THE ADVANTAGES

CLASSE 300X13E
DOES NOT CHANGE
THE INSTALLATION RULES

Forget installation complexity and configuring an Ethernet network and keep the simplicity of 2 wires connection. Everything stays the same thanks to the Wi-Fi technology integrated in the video internal unit.

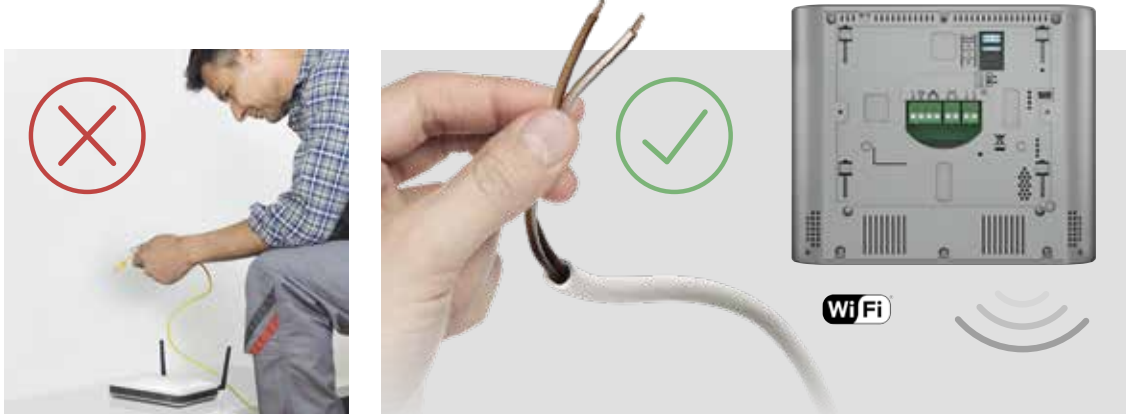

Simple and intuitive configuration

The configuration requires no IT skills. You must only configure the classic 2 wires system parameters (entrance panel and internal unit SCS addresses, etc.). Your customer manages all the configurations

of the Wi-Fi network and the App independently and intuitively. If necessary he can call the BTicino after-sales service directly by means of the Help button integrated in the application.

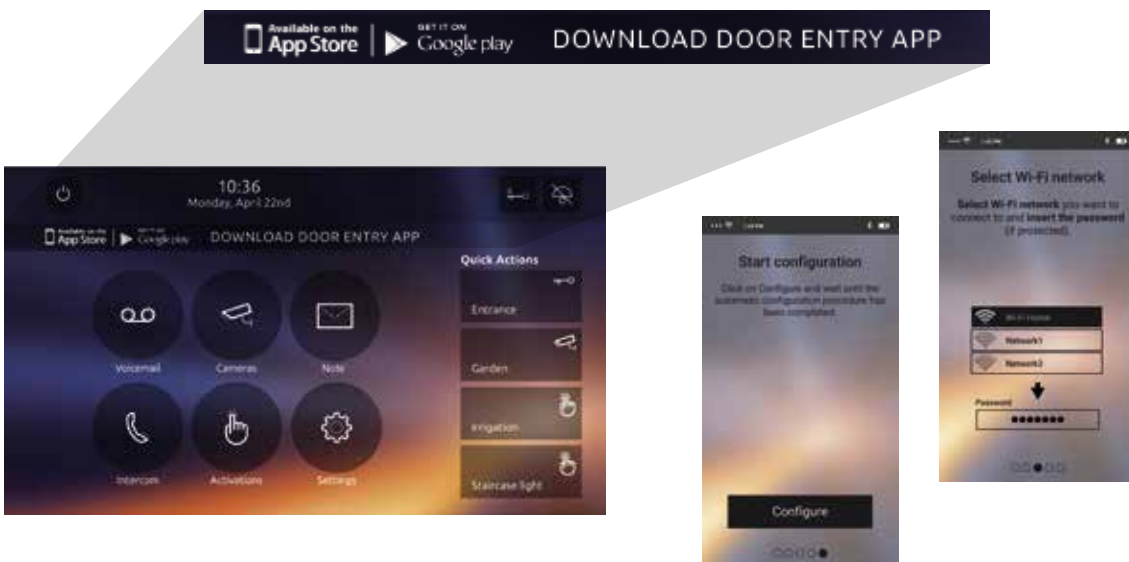

DOOR ENTRY APP

DESIGNED
FOR THE
FINAL USER



DOOR ENTRY is the App which lets you, using your smartphone, manage the video internal unit calls locally and remotely or with a simple touch open the gate, activate the cameras and switch the garden timed lights on. Configuring the App needs just a few steps and, thanks to the BTicino Cloud, the remote connection is totally automated and managed with the maximum level of security.



Scan the QR Code with your smartphone and download the Android App.



Scan the QR Code with your smartphone and download the iOS App.

Home Page screen

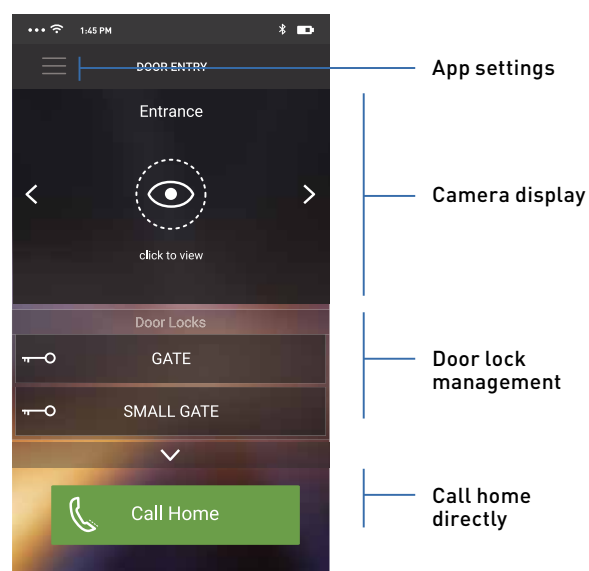

Incoming call screen

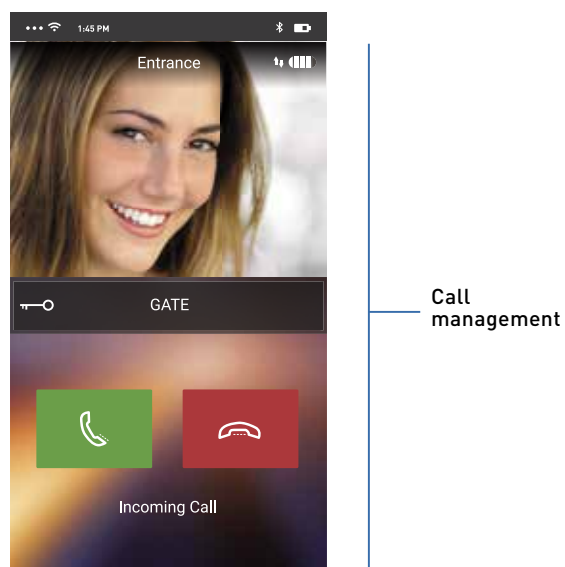

User interface designed starting from the most commonly used functions.



Select the camera and press to activate it

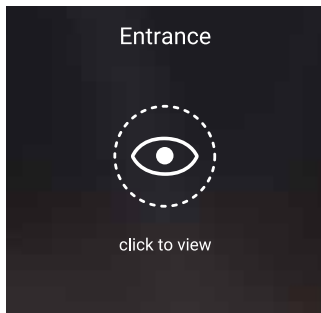

Answering the internal unit is as easy as answering a normal telephone call

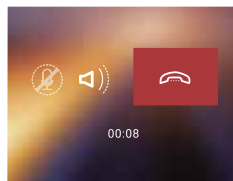
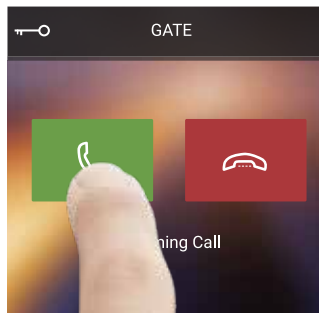

To open the door slide the key to the right – you will avoid opening the door accidentally

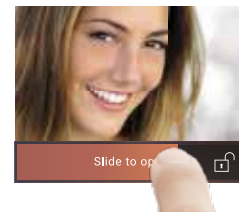
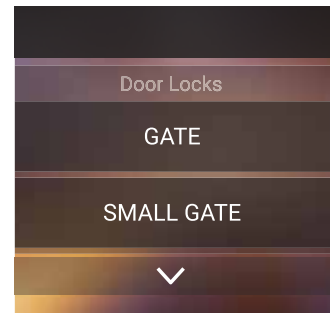

It is possible to activate and deactivate the video door entry answering machine directly with the App

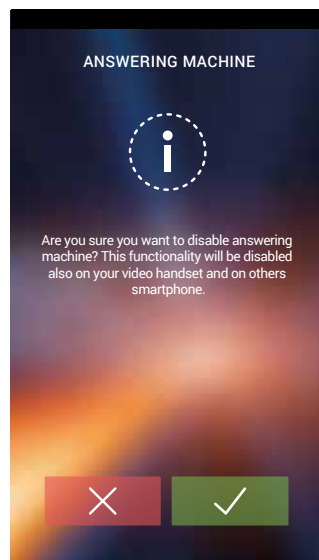
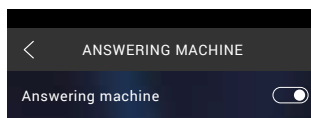
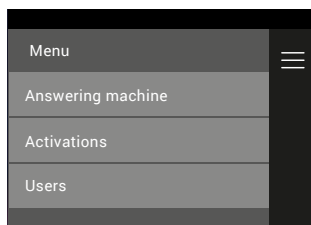

Touch to display the recorded message

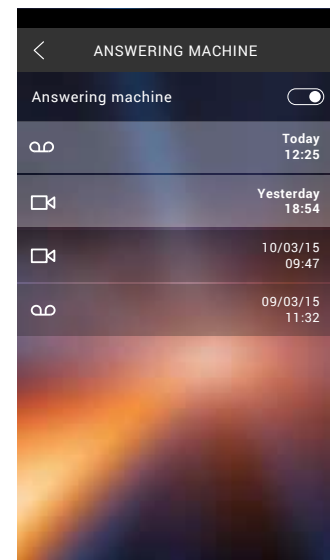

IMMEDIATELY CONNECTED AND CONFIGURED

After installing the App, a guided procedure allows the association between smartphone and CLASSE 300X13E in 3 simple steps.



1 Once the Wi-Fi connection is activated select the network you want to connect to



2 Enter your Wi-Fi network password



3 Once the configure key is pressed, the App will search for the Classe 300X13E and will connect automatically, self-configuring

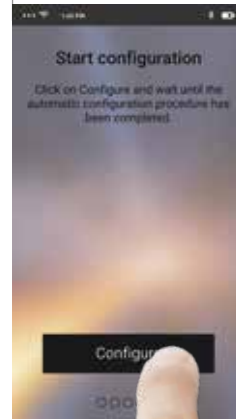

LOCAL



The connection to the dedicated Cloud totally automates the configuration on the home network (you do NOT need to configure your router).

The video internal unit transfers all the configuration of the 2 wires video door entry system (cameras, door locks, activations etc.) to the App and updates automatically after each modification.

REMOTELY

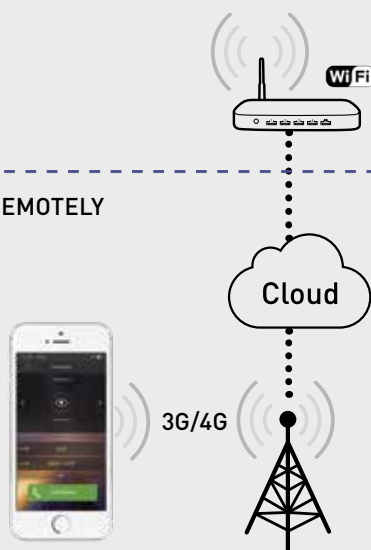

On the video internal unit you can always display the mobile devices associated to it and decide which to disconnect or cancel at any time.



Open
at integration
with connected
third-party
devices
to extend your
user experience

BTICINO
Classe 300X **WiFi**

CONNECTED AND INTEROPERABLE

From now on the integration with the **NETATMO** Smart Indoor and Smart Outdoor Cameras simplifies and strengthens the control of your home. It displays video from your BTicino and NETATMO cameras in an integrated way, answers the courier who rings your internal unit and checks that he actually delivers the package you are waiting for... All this is now possible from a single application: **DOOR ENTRY**.



BTICINO
Door Entry App

DO YOU WANT TO KNOW MORE? Go to the site www.bticino.com



NETATMO
Smart Indoor
Camera



The configuration to associate the devices is very simple.

No extra wiring/accessory is required.

It is done directly from the Classe 300X(*) video internal unit, on selecting "Compatible devices" from the configuration menu and activating the NETATMO camera(s) which will automatically appear on the screen.

NOTE (*): Firmware from version 1.7.8 and later.



NETATMO
Smart Outdoor
Camera

DO YOU WANT TO KNOW MORE? Go to the site www.netatmo.com

EXAMPLES OF INTEGRATION AND USE OF CLASSE 300X WITH NETATMO CAMERAS



NETATMO
Smart Outdoor
Camera

Directly from the DOOR ENTRY APP, in addition to the camera(s) and external pushbutton panel, it also displays the extra NETATMO Wi-Fi cameras.

1. The DOOR ENTRY APP displays the NETATMO camera pictures

1. 2. 3. 4.



NETATMO
Smart Indoor
Camera

Thanks to the face-recognition technology, the NETATMO camera can recognise your children and report the information on the DOOR ENTRY APP.

3. It displays whether your son has come home from school

1. 2. 3.

2. Displays the actual delivery of the packages once the gate has been opened for the courier

1. Hello, I have a package to deliver.

2. Hello, leave it in the garden in front of the house entrance. Thank you.

3.

4.

5.

4. You can choose not to open remotely if there is already someone in the house.

1. Hi, I'm home.

2.

3. Maria

4. Maria is at home let her answer the call.

5.

6. CLACK

PERFECT TO REPLACE YOUR OLD 2 WIRES INTERNAL UNIT



Classe 300X13E is the best solution available for renewing your internal unit.

In existing **totally 2 wires** systems you can update and replace your old internal unit (*) or video internal unit with CLASSE 300X13E. Thanks to the Wi-Fi connectivity you do not even need extra wiring.

Villa or single-family context

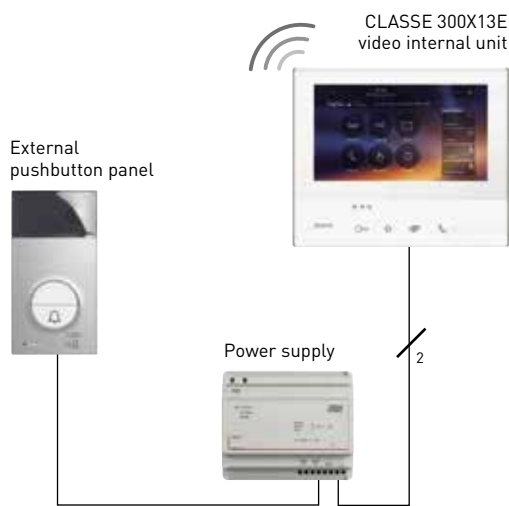

Apartment block or multi-family context

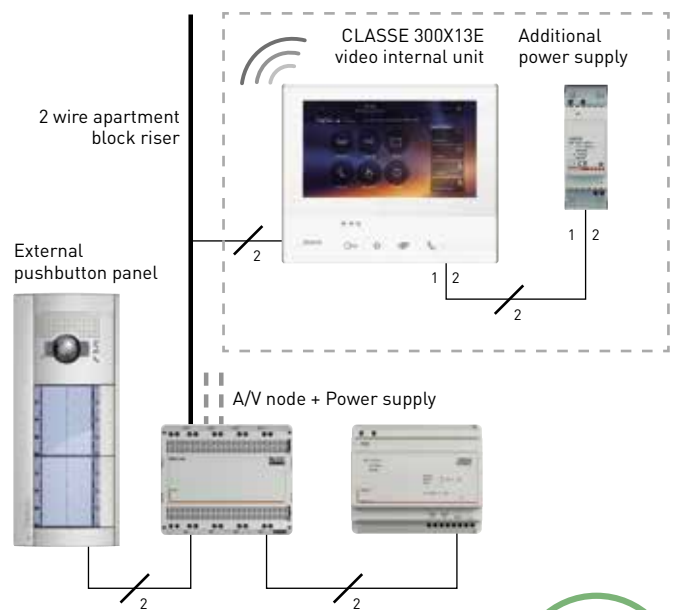

In multi-family systems (apartment blocks) you need the additional power supply of the CLASSE 300X13E video internal unit.

Also suitable for renewing the entire system.

CLASSE 300X13E has 2 wires technology. Unlike solutions based on Ethernet/IP systems, the 2 wires technology is the **best solution for refurbishments** because a pair of existing wires can be used.



(*) Will be transferred the audio call only.

The pictures shown on the display are exclusively for illustrational and promotional purposes.



CLASSE 300

A STYLISH CHOICE



Elegant design and modern technology

CLASSE 300 is the range of handsfree video internal units with a wide **7" TOUCH SCREEN** display enhanced by the glossy finish glass effect.

The curved and metalised profile with rounded corners helps to cancel the perception of thickness giving a **UNIQUE STYLISTIC YIELD**.



The main functions can be activated by means of **TOUCH SENSITIVE** keys placed in an easily identifiable area with **TACTILE GUIDE** for easier recognition.



CLASSE 300 has been awarded this prestigious international recognition confirming BTicino's capacity in combining technology and design.

CLASSE 300 A STYLISH CHOICE



CLASSE 300X13E combines unique and innovative style with advanced technology which allows absolute freedom, thanks to the Wi-Fi connection.





CLASSE 300 is available in two finishes, light and dark. It can be wall and table installed.



Light finish



Dark finish



Table-mounted installation with accessory supporting frame 344632



The **TOUCH SENSITIVE** capacity keys which control the main video door entry functions come with tactile guides for easier recognition.

A SIMPLE APPROACH TO EVERYDAY GESTURES



Door lock release



Camera activation



Favourites which can be configured



Handsfree communication

Intuitive access to all functions



Allows access to the visitors you want



Answer your visitor calls



You can adjust the screen settings and select from different backgrounds and ring tones



See what is happening outside: you can see the pictures from the external pushbutton panel camera or from the cameras connected to your system



Use the CLASSE 300 to communicate with the other rooms of your home or with other homes



You can decide that the CLASSE 300 opens the door automatically when you receive a call (you can activate and deactivate the function when you want)



If you need peace and quiet you can silence the CLASSE 300 and reactivate it when you want



You can activate other functions which are connected to your system, such as the staircase lights or the locks of other gates



Leave a message with the NOTE function



Activate the answering system function (only CLASSE 300X13E - CLASSE 300V13M), to record a film clip of the visitor who was looking for you. When you are out, you can record a message for people looking for you.



CLASSE 300

Features and functions



FEATURES				
COLOUR VIDEO 7" TOUCH SCREEN	●	●	●	●
HANDSFREE	●	●	●	●
FINISH	light	dark	light	dark
AVAILABILITY IN KIT	●		●	
INSTALLATION	wall / table	wall / table	wall / table	wall / table
FUNCTIONS AVAILABLE FROM INTERNAL UNIT				
DOOR LOCK RELEASE	●	●	●	●
STAIRCASE LIGHT ACTIVATION	●	●	●	●
ENTRANCE PANEL / SCROLLING ACTIVATION	●	●	●	●
INDUCTIVE LOOP ⁽¹⁾	●	●	●	●
INTERCOM ⁽²⁾	●	●	●	●
CALL TO THE FLOOR	●	●	●	●
NOTE FUNCTION	●	●	●	●
PROFESSIONAL STUDIO (OFFICE) FUNCTION	●	●	●	●
ANSWERING MACHINE	●	●		
WI-FI CONNECTION	●	●		
FUNCTIONS AVAILABLE FROM DOOR ENTRY APP				
VIDEO DOOR ENTRY CALL ANSWER	●	●		
DOOR LOCK RELEASE	●	●		
ANSWERING MACHINE	●	●		
STAIRCASE LIGHT ACTIVATION	●	●		
INTERCOM CALL FROM SMARTPHONE TO VIDEO INTERNAL UNIT	●	●		
INTEGRATION OF NETATMO SMART CAMERAS	●	●		
ENTRANCE PANEL / SCROLLING ACTIVATION	●	●		

1) Use by people wearing hearing aids fitted with T selector

2) Audio call, max. 3 minutes, between internal units of the same apartment/different apartments

Front view

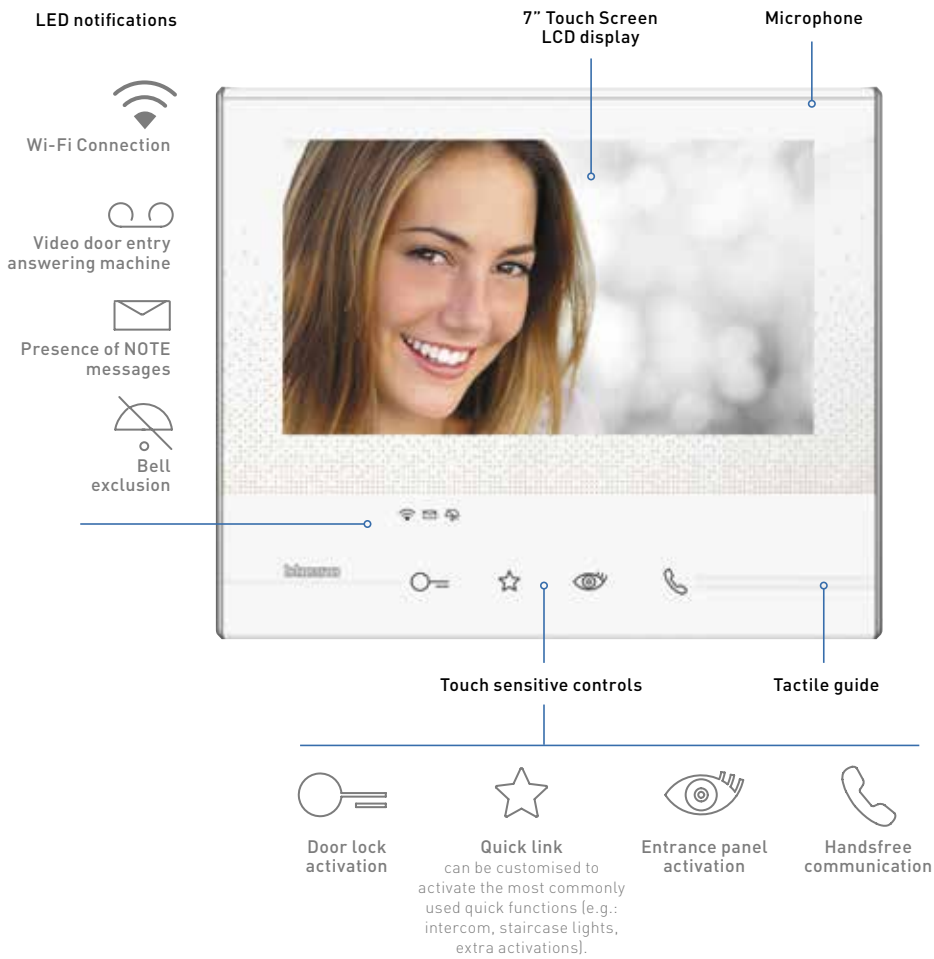

Rear view

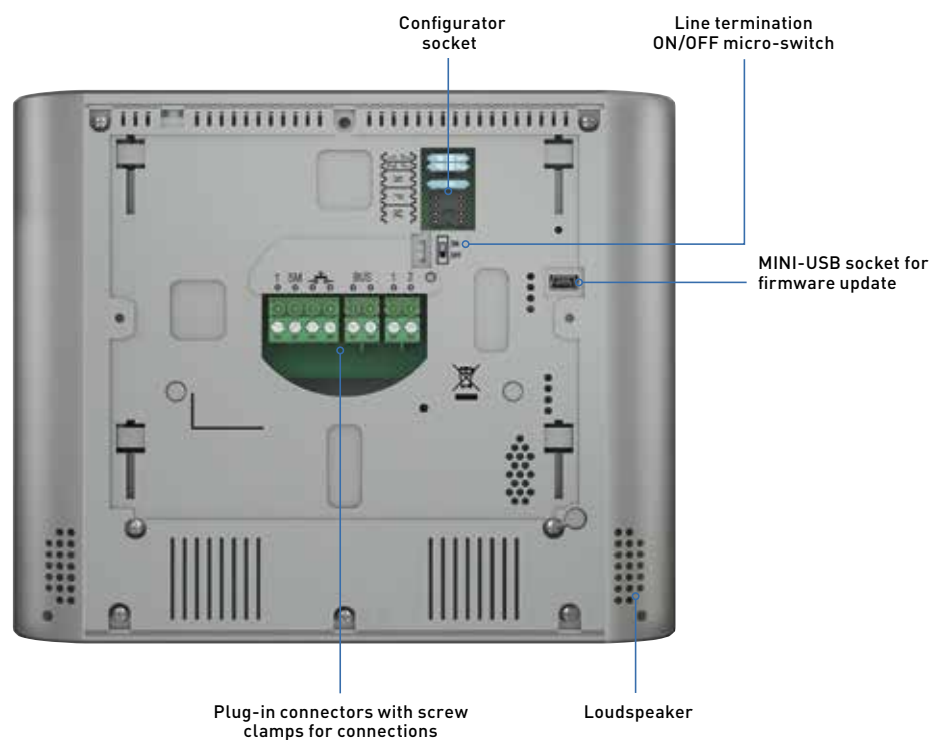

CLASSE 300

Catalogue



344642



344643



344612



344613



344632

Item	CLASSE 300X13E HANDSFREE VIDEO INTERNAL UNIT
344642	<p>2 wire/Wi-Fi handsfree video internal unit with inductive loop, 7" Touch Screen LCD display and video door entry answering machine with call audio/video memory – light finish. It has capacitive keys for the control of the main video door entry functions: door lock release, handsfree connection, entrance panel activation /camera scrolling and Favorite key (can be configured to activate the quick actions most frequently used - eg: staircase lights control, Intercom, additional activations). Tactile guide for easy access to door lock and handsfree capacitive connection keys. LEDs used for: call exclusion, notification of messages from switchboard and note. Access to adjustments and functions using the touch display. NOTE function - for writing using the keypad, or for voice recording of messages and/or notes for the other residents of the apartment (e.g.: call plumber, do the shopping, etc.). Possibility of voice communication with the switchboard - if present in the system - after a specific call. The device must be configured by physically connecting the configurators, or using the menu, which will give better possibilities of customisation of associated functions and texts. Also, thanks to the Wi-Fi connection, you can associate the video internal unit to the Door Entry App (available for Android and iOS). You can manage the main video internal unit functions (receiving calls, opening the door lock, activating the entrance panel/cycling and extra activations).</p>
344643	As 344642 but with dark finish.

Item	CLASSE 300V13E HANDSFREE VIDEO INTERNAL UNIT
344612	<p>2 wire / handsfree video internal unit with inductive loop and 7" Touch Screen LCD display – light finish. It has capacitive keys for the control of the main video door entry functions: door lock release, handsfree connection, entrance panel activation/camera scrolling and favorite key (can be configured to activate the quick actions most frequently used - eg: staircase lights control, Intercom, additional activations). Tactile guide for easy access to door lock and handsfree capacitive connection keys. LEDs used for: call exclusion, notification of messages from switchboard and note. Access to adjustments and functions using the touch display. NOTE function - for writing using the keypad, or for voice recording of messages and/or notes for the other residents of the apartment (e.g.: call plumber, do the shopping, etc.). Possibility of voice communication with the switchboard - if present in the system - after a specific call. The device must be configured by physically connecting the configurators, or using the menu, which will give better possibilities of customisation of associated functions and texts.</p>
344613	As 344612 but with dark finish.

ACCESSORY FOR TABLE SUPPORT AND CABLE

344632	Accessory support for the table-top installation of the Classe 300 video internal units range.
336803	8-way cable with connector for table-top support connection.

2 DIN ADDITIONAL POWER SUPPLY

346020	Additional 2 DIN power supply to be used to locally supply Classe 300X13E video internal units in multi-family systems.
--------	---

DIMENSIONAL DATA

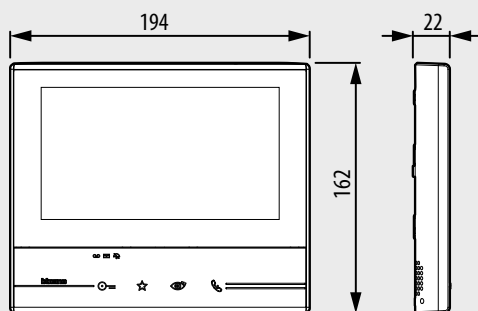

344612 – 344613 – 344642 – 344643

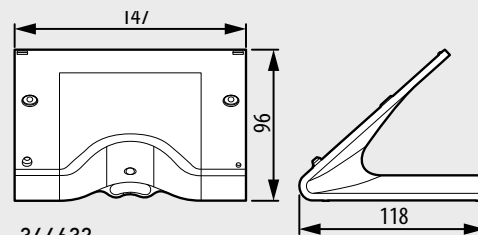

344632

Size in mm

CLASSE 300

Also available in [kit](#)



363911

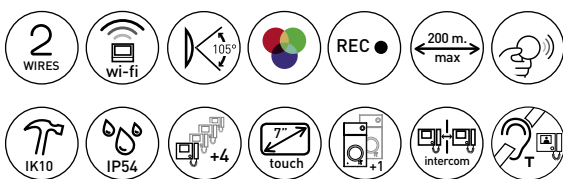

363511

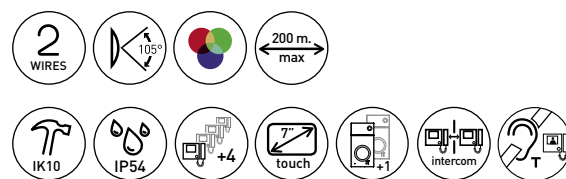

Item	HANDSFREE VIDEO KIT CLASSE 300X13E – LINEA 3000
363911	<p>One-family handsfree kit with smartphone call repetition made up of:</p> <ul style="list-style-type: none"> - 1 Linea 3000 pushbutton panel (1 call) – 343091 (presetting for a second call). - 1 Classe 300X13E - 344642 video internal unit - 1 Power supply with integrated video adapter - 346050 - 1 Relay accessory to control door lock opening not managed by BUS SCS - 346250 - 1 Set made up of coloured key cards and two Clear discs for door lock release functions

Item	HANDSFREE VIDEO KIT CLASSE 300V13E - LINEA 3000
363511	<p>One-family handsfree kit made up of:</p> <ul style="list-style-type: none"> - 1 Linea 3000 pushbutton panel (1 call) – 343081 (presetting for a second call). - 1 Classe 300V13E - 344612 video internal unit - 1 Power supply with integrated video adapter 346050 - 1 Relay accessory to control door lock opening not managed by BUS SCS - 346250

CLASSE 300X13E

Legal notes

To use the video door entry call repeat service on a smartphone, the customer must acquire the technical equipment which allows access to the Internet, on the basis of an agreement made by the customer himself with an ISP (Internet Service Provider). BTicino plays no part in this. The customer must install the Door Entry App on his smartphone so that he can use some services which BTicino supplies as extras to the normal basic functions of the Classe 300X13E video internal unit. The services offered by means of the App require being able to interact with Classe 300X13E remotely and through the Internet. In these cases the integration and good working between Classe 300X13E and App may depend on:

- quality of the Wi-Fi signal
- type of access contract to the home Internet
- type of data contract on the smartphone

When one of these 3 elements does not conform with the specifications required for product operation, BTicino accepts no responsibility for any faults. The product supports a VoIP streaming system. You must therefore check with your smartphone contract – data network – that it does not block it. We should also like to inform you that the service provided by BTicino – remote use via App – involves the use of data. The cost linked to their use depends on the type of contract which the customer has signed with an ISP (Internet Service Provider) and is his responsibility.

BTicino SpA
Viale Borri, 231
21100 Varese - Italy
www.bticino.com

BTicino S.p.A. reserves at any time the right to modify the contents of this booklet and to communicate, in any form and modality, the changes brought to the same.

AD-EXCM19PI300C/GB – Edition 03/2019